

1:	10,7*	↑
2:	9,3	↑
3:	9,4	↑
4:	10,0	↓
5:	9,7	↑
6:	10,2	↑
7:	10,2	↑
8:	10,1	↓
9:	10,2	←
10:	10,4	↓

**Serie: 97,0**

**Sum: 0,0**

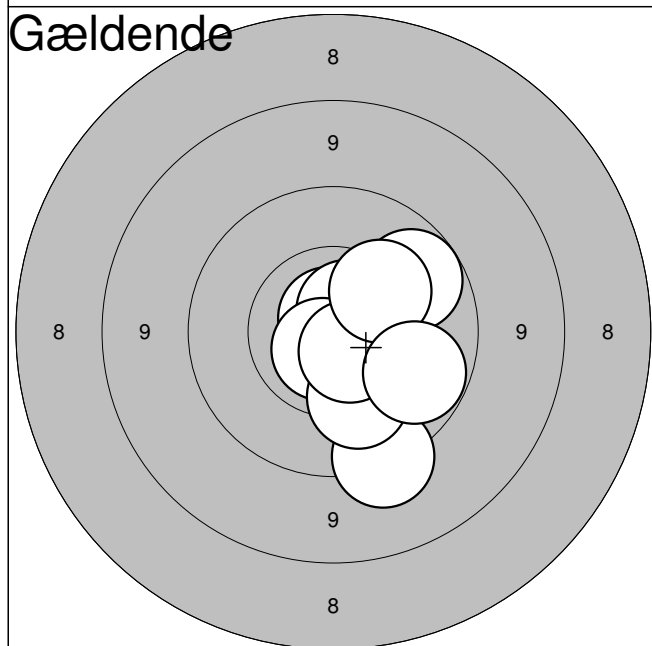

1:	10,8*	↑
2:	10,0	→
3:	9,5	↓
4:	10,7*	↑
5:	10,6*	→
6:	10,7*	↓
7:	10,2	↓
8:	10,7*	↓
9:	10,3	↑
10:	10,0	→

**Serie: 99,0**

**Sum: 99,0**

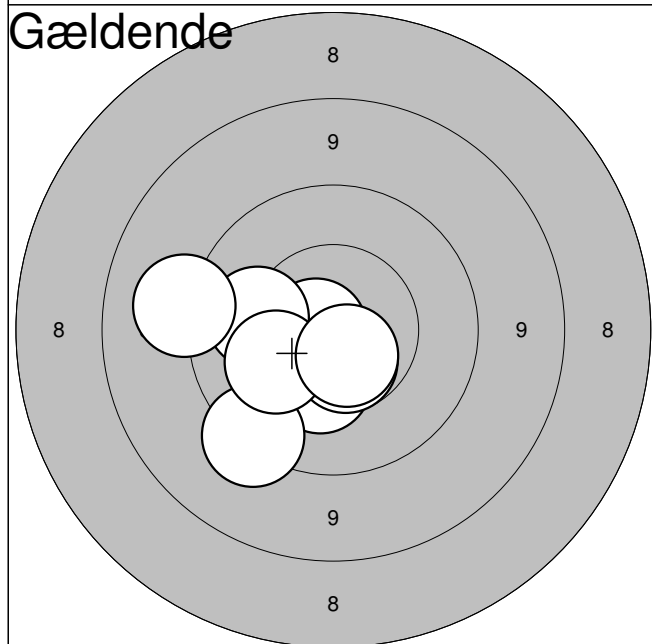

11:	10,8*	←
12:	10,4	↓
13:	10,5	←
14:	10,8*	←
15:	10,6	↓
16:	9,5	↓
17:	10,1	←
18:	10,3	←
19:	9,3	←
20:	10,6*	↓

**Serie: 98,0**

**Sum: 197,0**

Hold  
**40**

Bane  
**2**

# Viggo Kristensen

Ulsted Skf.

V1

Jyllandsstævne 2011 - riffel

Aalborg Skyttekreds

Prøveskud

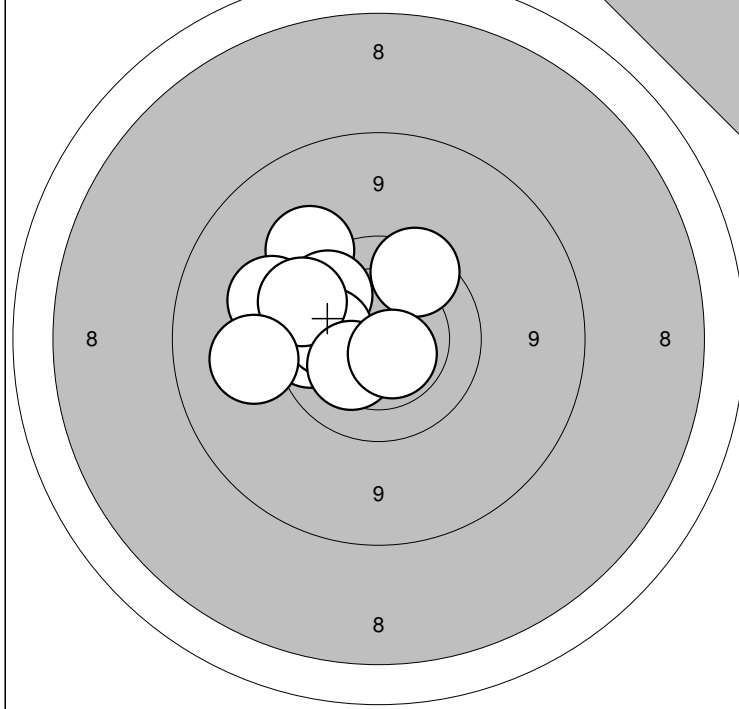

Prøveskud

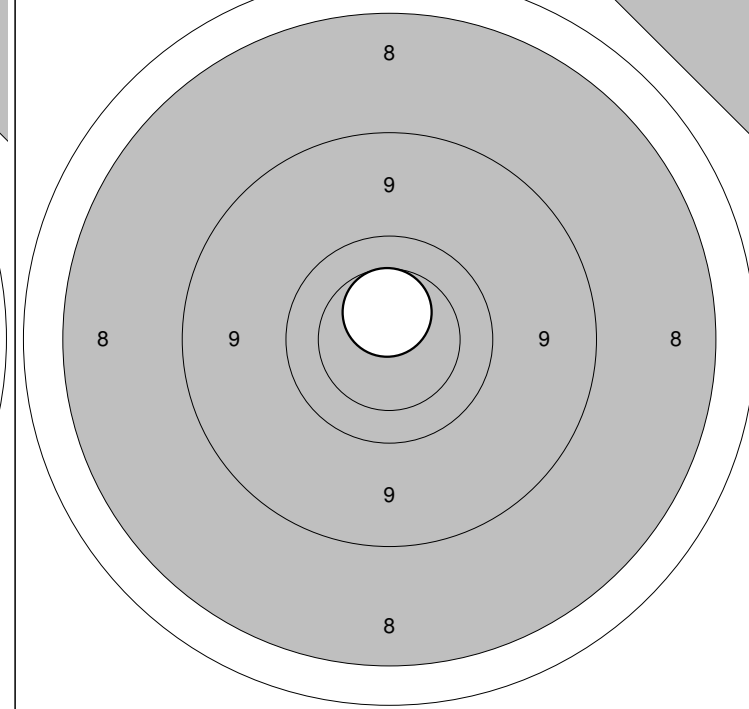

1: 9,9 ←  
 2: 9,8 ↗  
 3: 9,4 ↗  
 4: 9,9 ↗  
 5: 10,1 ←

6: 9,4 ↖  
 7: 9,7 ↖  
 8: 9,3 ←  
 9: 10,3 ↘  
 10: 10,6\* ↘

Serie: 93,0

Sum: 0,0

11: 10,5 ↑

Serie: 10,0

Sum: 0,0

Gældende

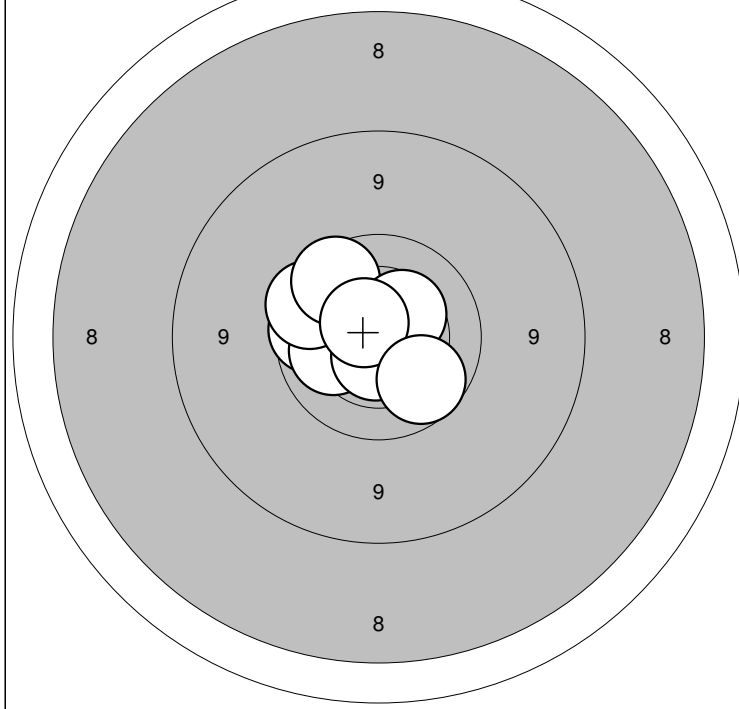

Gældende

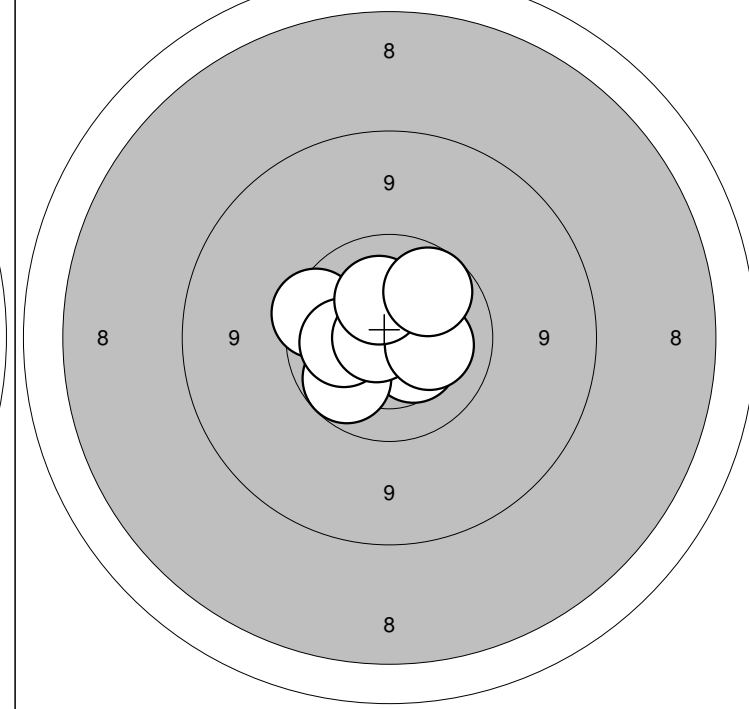

1: 10,5\* ↘  
 2: 9,9 ←  
 3: 10,2 ←  
 4: 10,7\* ↗  
 5: 10,6\* ↓

6: 9,8 ↖  
 7: 9,8 ↗  
 8: 10,4 ↗  
 9: 10,6\* ↗  
 10: 9,9 ↘

Serie: 96,0

Sum: 96,0

11: 10,4 ↘  
 12: 9,8 ←  
 13: 10,0 ↘  
 14: 10,2 ←  
 15: 10,6\* ↑

16: 10,7\* ←  
 17: 10,3 ↗  
 18: 10,3 →  
 19: 10,3 ↑  
 20: 9,9 ↗

Serie: 98,0

Sum: 194,0

Hold  
**40**Bane  
**3****Rasmus M. Larsen**

Vilsted Skf.

ÅK1

Jyllandsstævne 2011 - riffel

Aalborg Skyttekreds

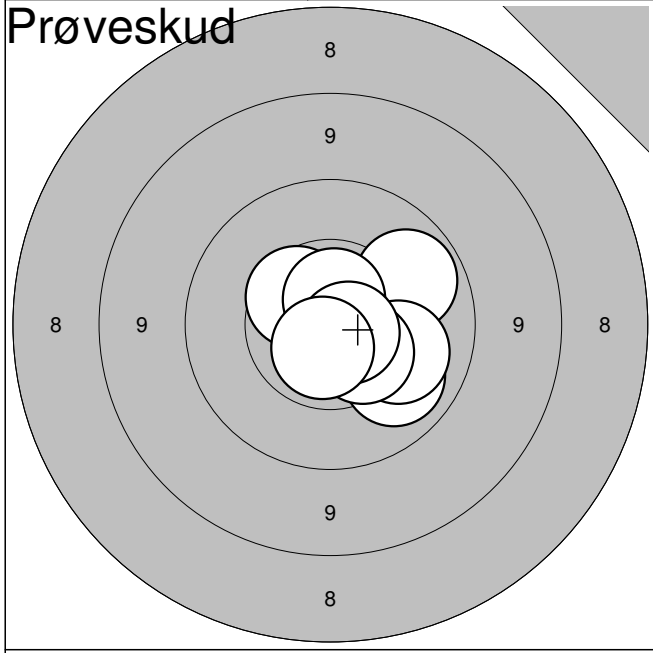
**Prøveskud**

1:	10,0	↗
2:	10,1	↘
3:	10,2	→
4:	10,5	↗
5:	10,5	↘
6:	10,7*	↑
7:	10,7*	↘
8:	10,7*	↘

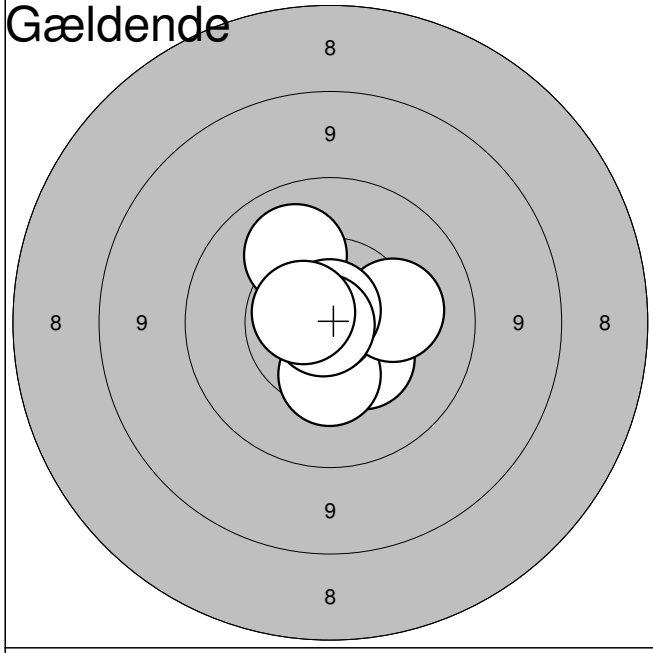
Serie: **80,0**Sum: **0,0****Gældende**

1:	10,4	↘
2:	10,8*	↗
3:	10,2	↗
4:	10,8*	→
5:	10,4	↘
6:	10,9*	←
7:	10,3	→
8:	10,8*	↑
9:	10,9*	←
10:	10,7*	←

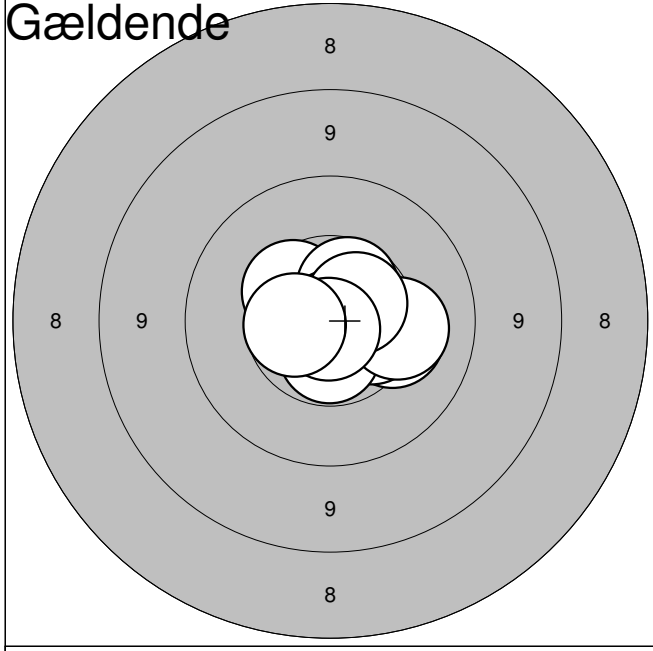
Serie: **100,0**Sum: **100,0****Gældende**

11:	10,3	→
12:	10,5	→
13:	10,6*	↘
14:	10,5	↗
15:	10,6	↗
16:	10,2	→
17:	10,9*	→
18:	10,6*	↗
19:	10,9*	↘
20:	10,6	←

Serie: **100,0**Sum: **200,0**

Jyllandsstævne 2011

Hold  
**40**

Bane  
**4**

# Christian Frost

Aalborg Skyttekreds

ÅK2

Jyllandsstævne 2011 - riffel

Aalborg Skyttekreds

Prøveskud

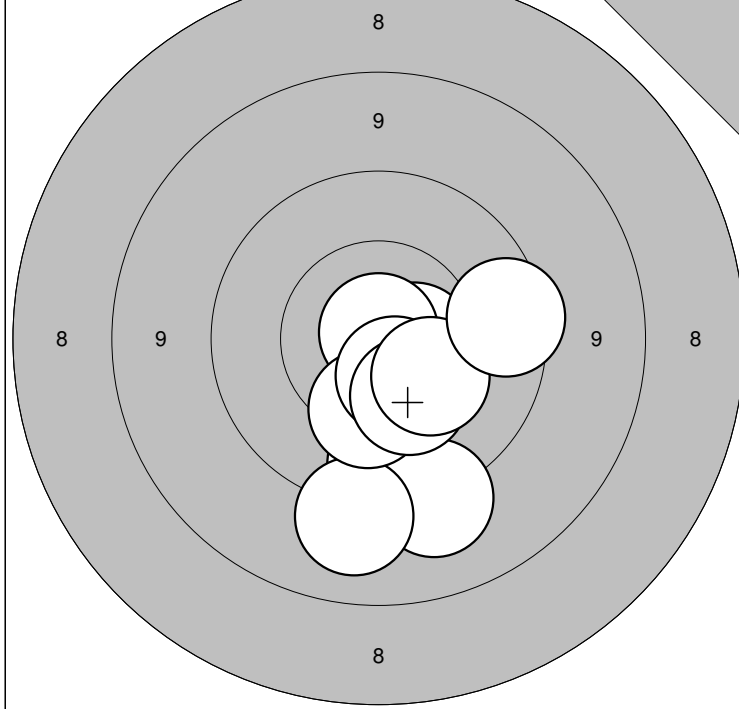

Prøveskud

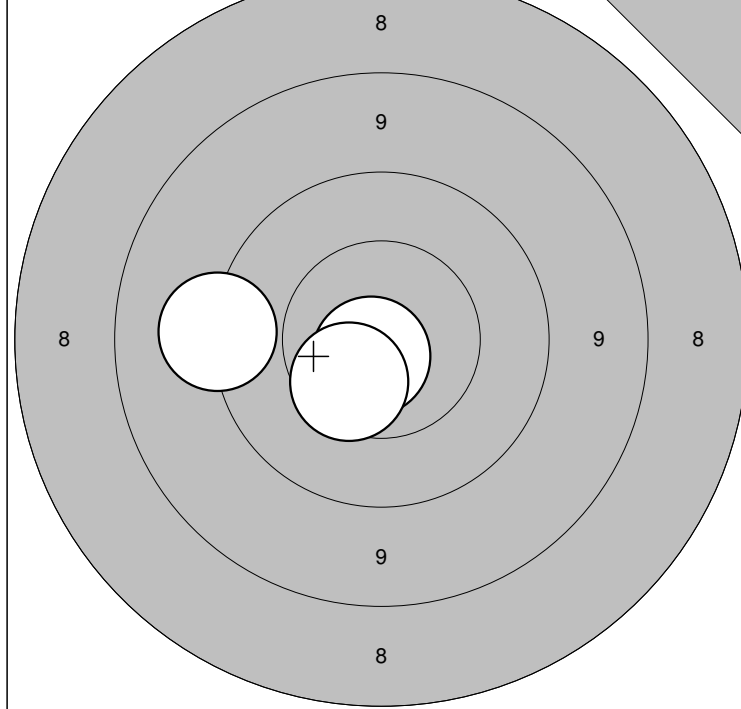

1: 9,8	↓	6:10,3	↓
2: 9,3	↓	7:10,6	↓
3: 9,2	↓	8:10,4	↓
4:10,6*	→	9:10,4	↓
5:10,9*	↑	10: 9,7	→

Serie: 96,0  
Sum: 0,0

11: 9,4	←
12:10,8*	↓
13:10,5	↓

Serie: 29,0  
Sum: 0,0

Gældende

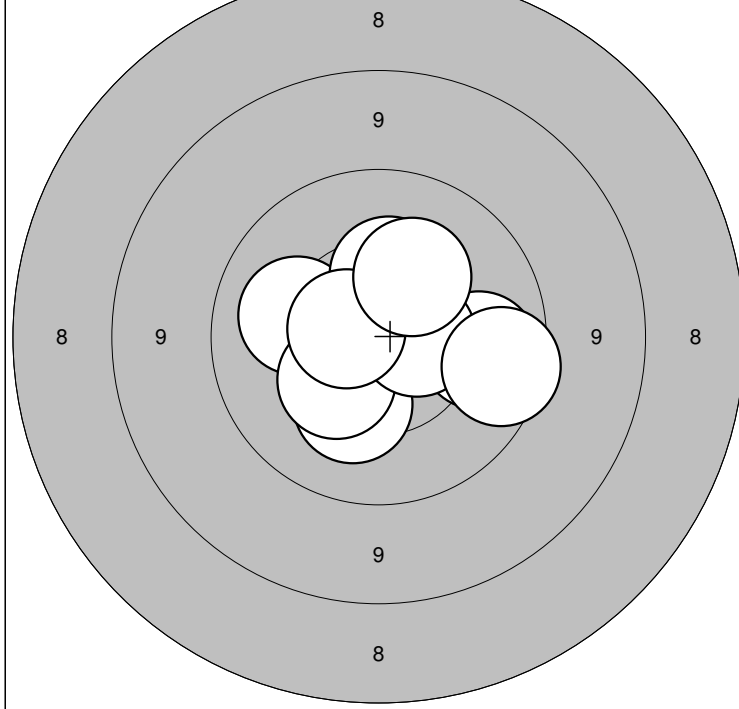

Gældende

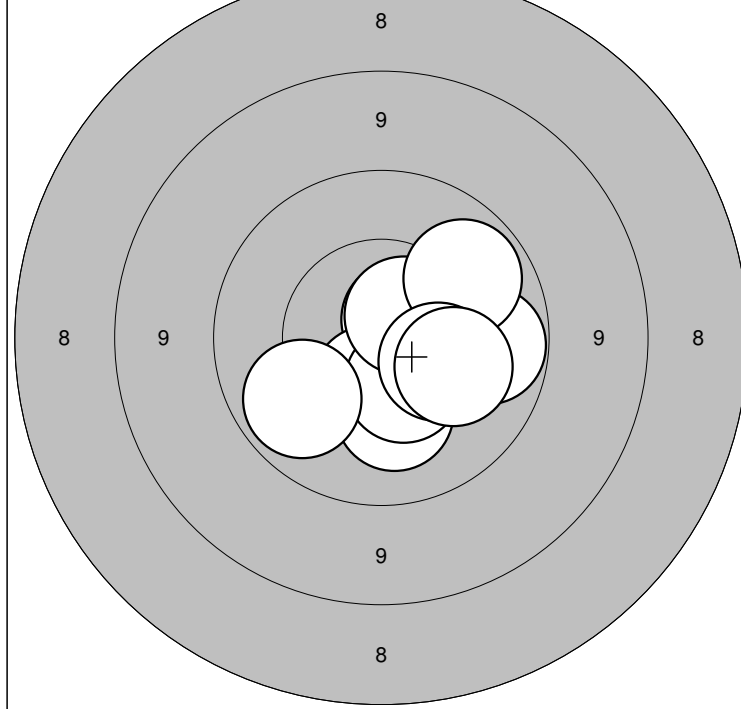

1:10,3	↓	6:10,4	↑
2:10,2	←	7:10,6*	→
3:10,4	↙	8: 9,8	→
4:10,0	→	9:10,6*	←
5:10,8*	↗	10:10,3	↗

Serie: 99,0  
Sum: 99,0

11:10,7*	↗	16:10,0	←
12:10,5	↓	17:10,7*	↗
13:10,0	→	18:10,0	↗
14:10,3	↓	19:10,4	→
15:10,5	↓	20:10,2	→

Serie: 100,0  
Sum: 199,0

Jyllandsstævne 2011

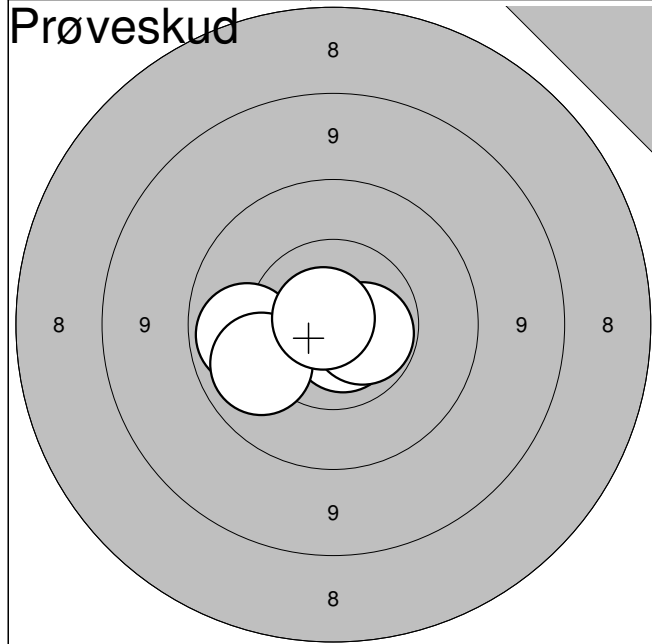

1:	10,7*	↘
2:	10,0	←
3:	10,1	↙
4:	10,6*	→
5:	10,8*	↗

Serie:	50,0
Sum:	0,0

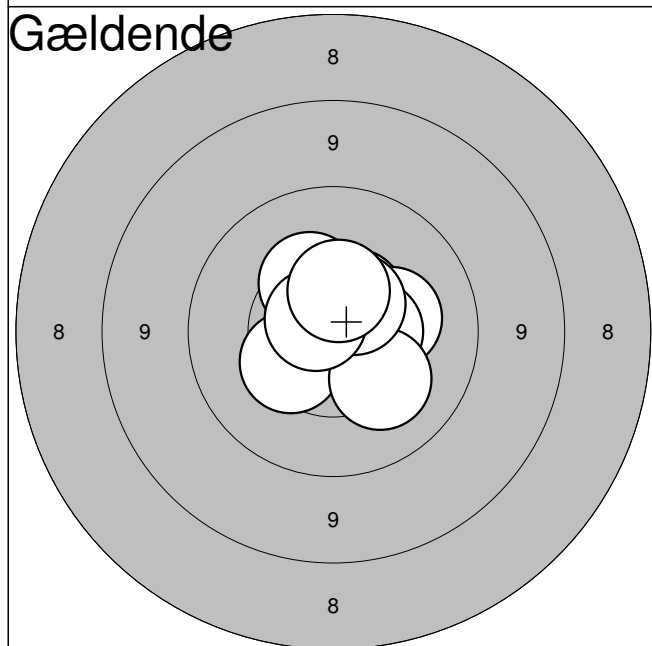

1:	10,6	↗
2:	10,7*	→
3:	10,3	→
4:	10,5	→
5:	10,4	↙
6:	10,4	↗
7:	10,2	↘
8:	10,6	↗
9:	10,7*	↗
10:	10,5	↑

Serie:	100,0
Sum:	100,0

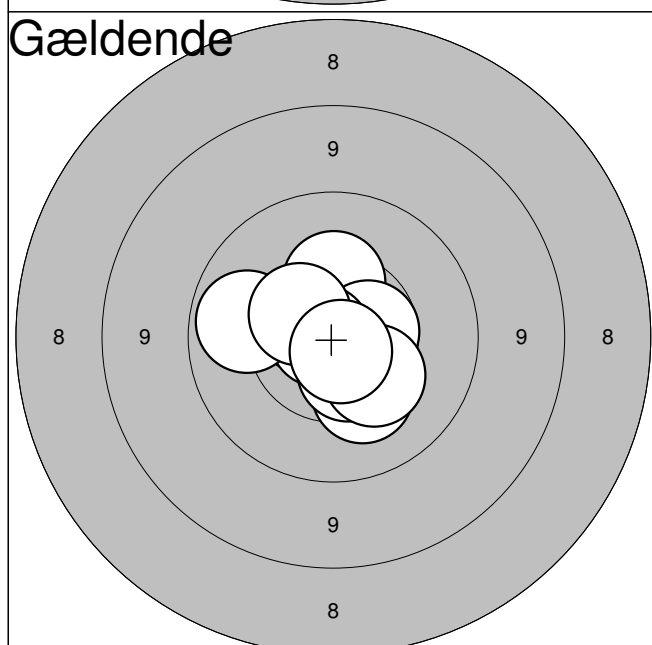

11:	10,4	↑
12:	10,6*	↗
13:	10,6	→
14:	10,3	↘
15:	10,8*	←
16:	10,6	↘
17:	10,3	↘
18:	10,0	←
19:	10,5	↗
20:	10,8*	↘

Serie:	100,0
Sum:	200,0

Hold  
**40**Bane  
**7****Christian S. Nielsen**

Vilsted Skf.

BK3

Jyllandsstævne 2011 - riffel

Aalborg Skyttekreds

Prøveskud

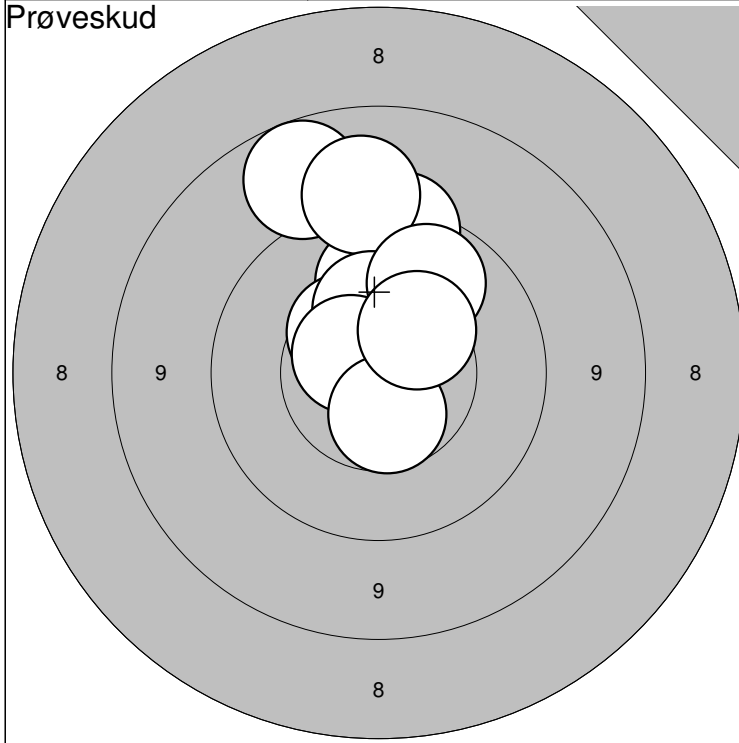

Prøveskud

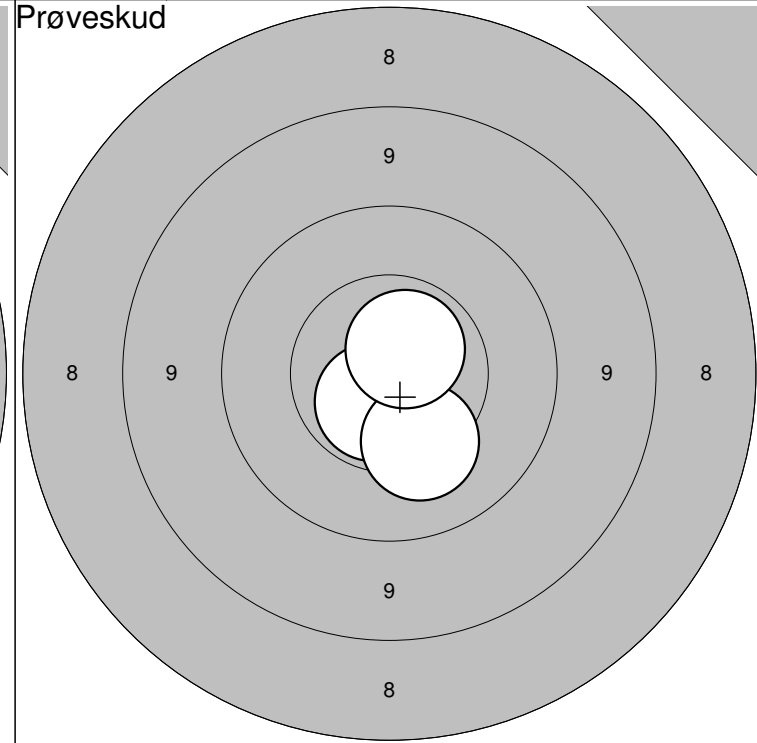

1: 9,6 ↑  
2: 10,1 ↑  
3: 9,0 ↗  
4: 9,2 ↑  
5: 10,5 ↖

6: 10,4 ↑  
7: 10,6\* ↖  
8: 10,6 ↓  
9: 10,0 ↗  
10: 10,4 ↗

Serie: 97,0  
Sum: 0,0

11: 10,7\* ↓  
12: 10,3 ↓  
13: 10,7\* ↗

Serie: 30,0  
Sum: 0,0

Gældende

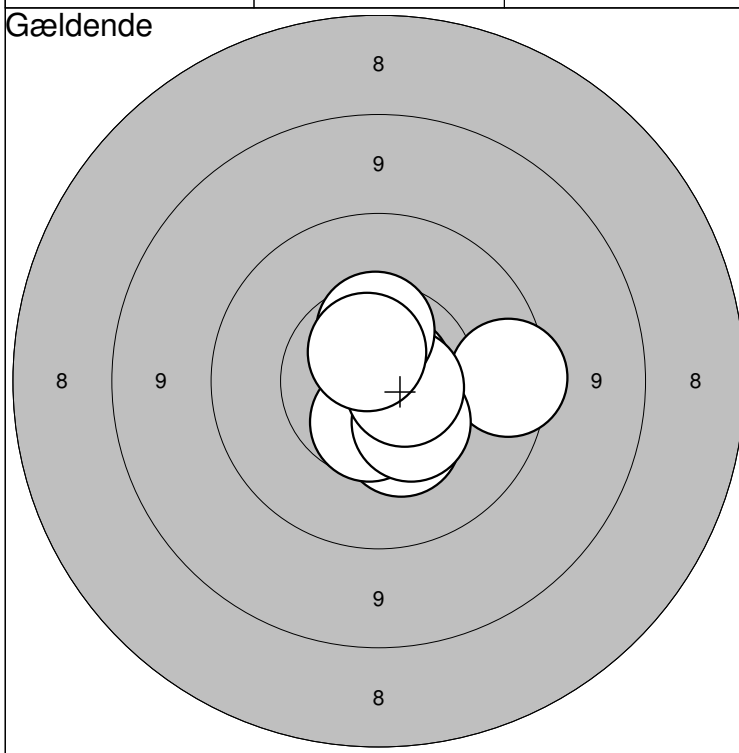

Gældende

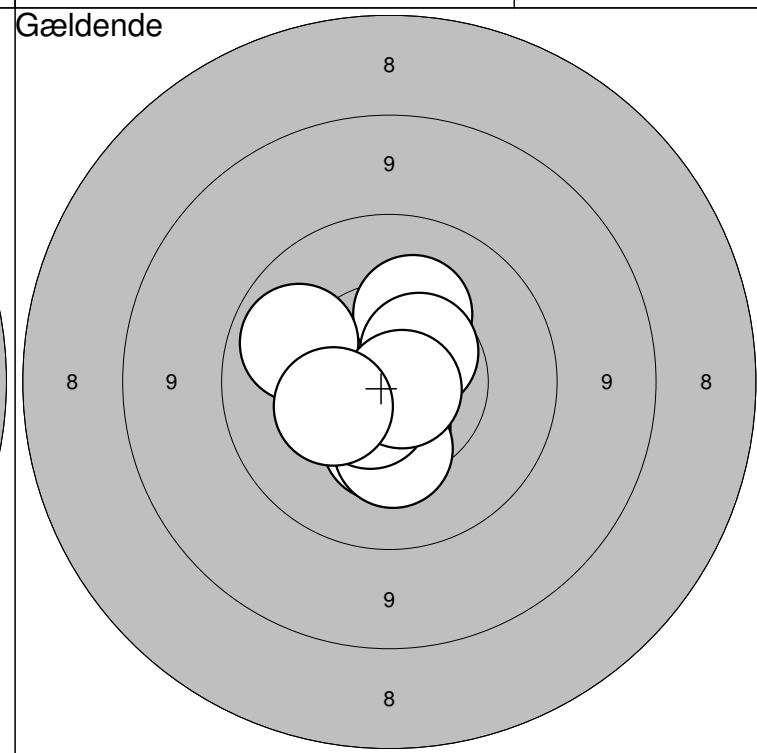

1: 9,7 →  
2: 10,6\* ↓  
3: 10,8\* ↗  
4: 10,4 ↓  
5: 10,7\* ↓

6: 10,6 ↓  
7: 10,5 ↓  
8: 10,7\* →  
9: 10,5 ↑  
10: 10,7\* ↗

Serie: 99,0  
Sum: 99,0

11: 10,5 ↓  
12: 10,4 ↓  
13: 10,7\* ↗  
14: 10,3 ↑  
15: 10,3 ↓

16: 10,6 ↗  
17: 10,1 ↖  
18: 10,6\* ↓  
19: 10,8\* ↗  
20: 10,4 ↖

Serie: 100,0  
Sum: 199,0

Jyllandsstævne 2011

Hold  
**40**

Bane  
**9**

# Marcus Hovkjær

Vilsted Skf.

BK2

Jyllandsstævne 2011 - riffel

Aalborg Skyttekreds

Prøveskud

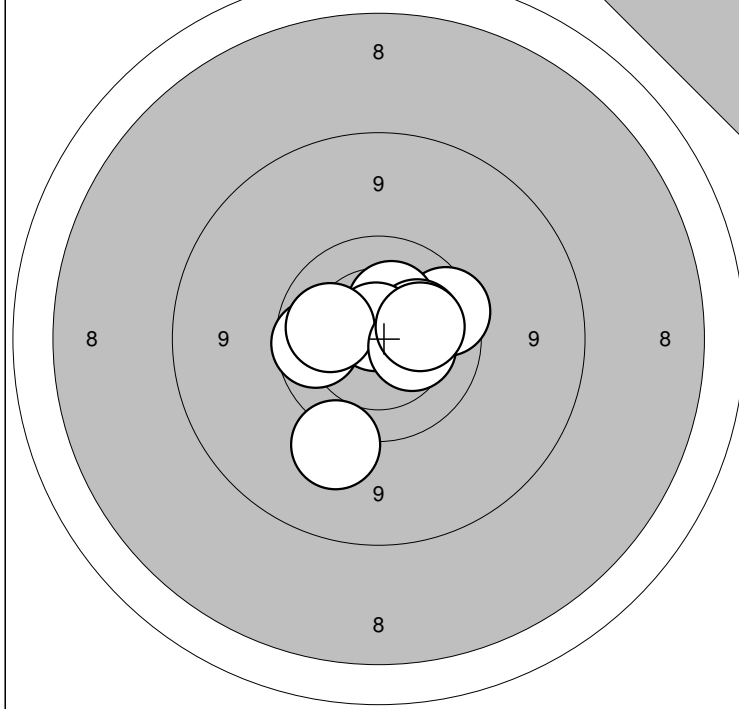

Prøveskud

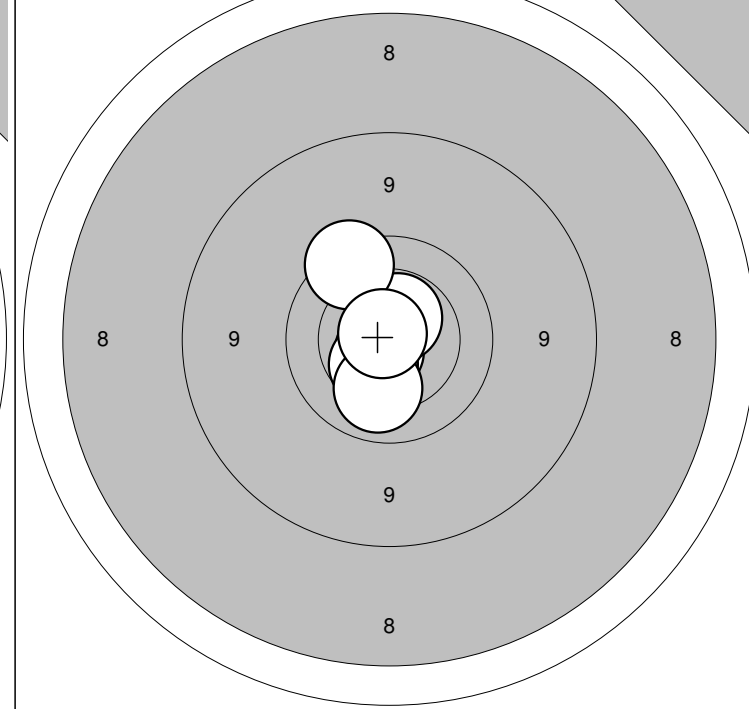

1:10,7\* ↗  
2: 9,8 →  
3:10,3 ↑  
4: 9,9 ←  
5:10,2 →

6:10,8\* ↑  
7:10,1 ←  
8:10,4 →  
9:10,2 →  
10: 9,4 ↓

Serie: 97,0

Sum: 0,0

11:10,7\* ↙  
12:10,4 ↓  
13:10,1 ↓  
14:10,6\* ↑  
15: 9,7 ↗

16:10,8\* ↖

Serie: 59,0

Sum: 0,0

Gældende

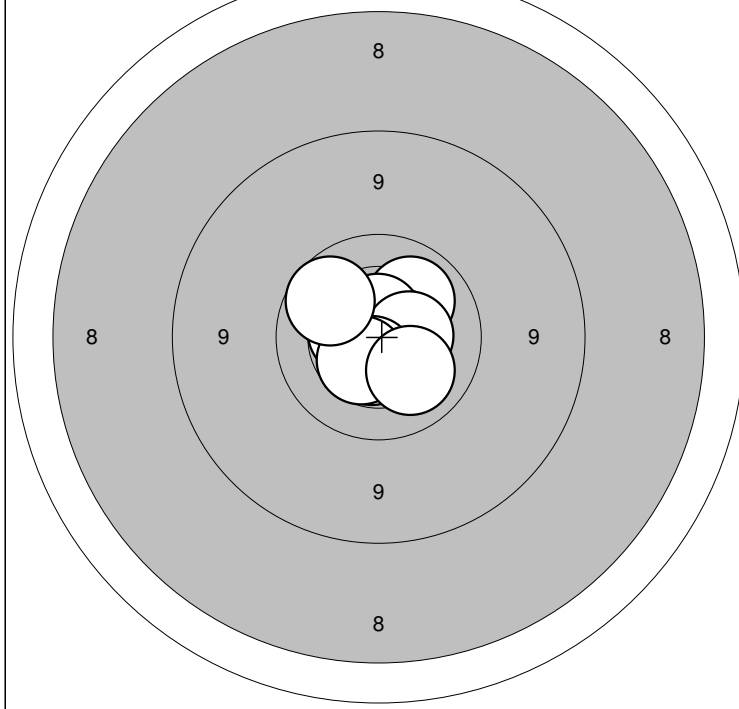

Gældende

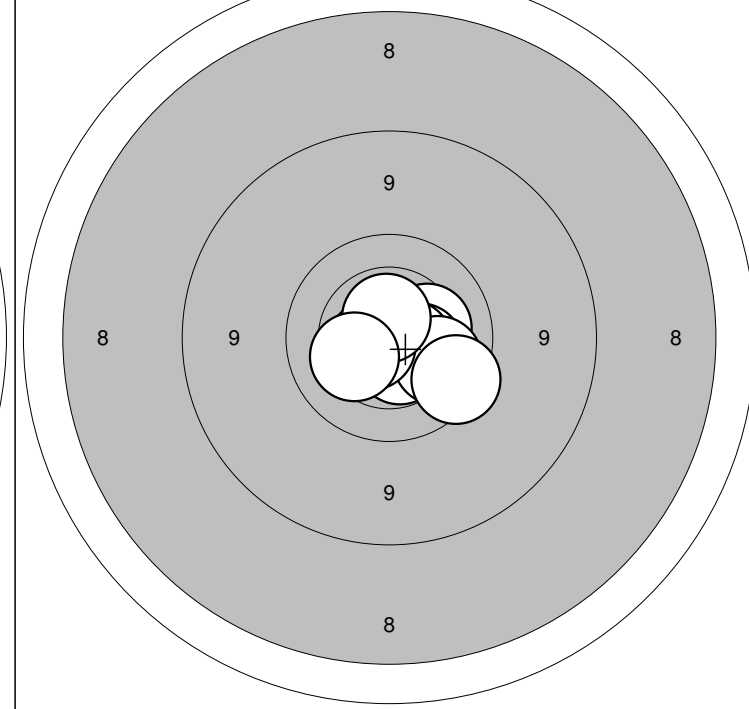

1:10,5\* ←  
2:10,1 ↗  
3:10,6\* →  
4:10,6\* ↘  
5:10,6\* ↑

6:10,4 →  
7:10,5\* ↓  
8:10,5 ↓  
9: 9,9 ↗  
10:10,2 ↓

Serie: 99,0

Sum: 99,0

11:10,3 →  
12:10,4 →  
13:10,7\* ↓  
14:10,6\* →  
15:10,5\* ↓

16:10,0 →  
17:10,6\* ←  
18:10,6\* ↑  
19:10,3 ←  
20: 9,8 ↘

Serie: 99,0

Sum: 198,0

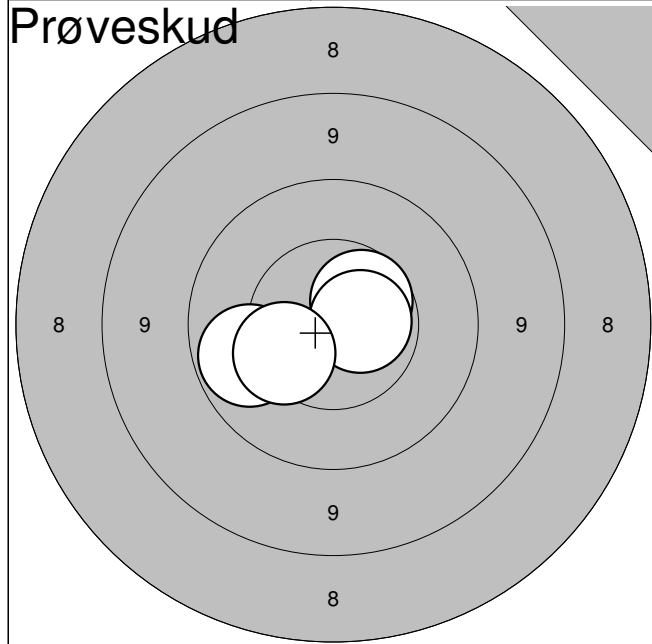

1:	10,6	↗
2:	10,7*	→
3:	10,0	↖
4:	10,3	↙
<b>Serie:</b>		<b>40,0</b>
<b>Sum:</b>		<b>0,0</b>

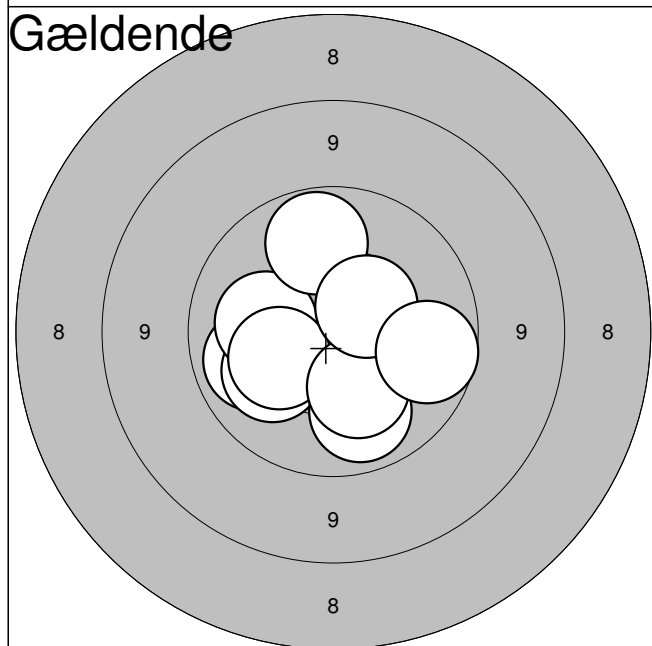

1:	10,1	↖
2:	10,2	↙
3:	10,2	↖
4:	10,5	↘
5:	10,3	↖
6:	10,1	↘
7:	10,3	↘
8:	10,0	↑
9:	10,5	↗
10:	9,9	→
<b>Serie:</b>		<b>99,0</b>
<b>Sum:</b>		<b>99,0</b>

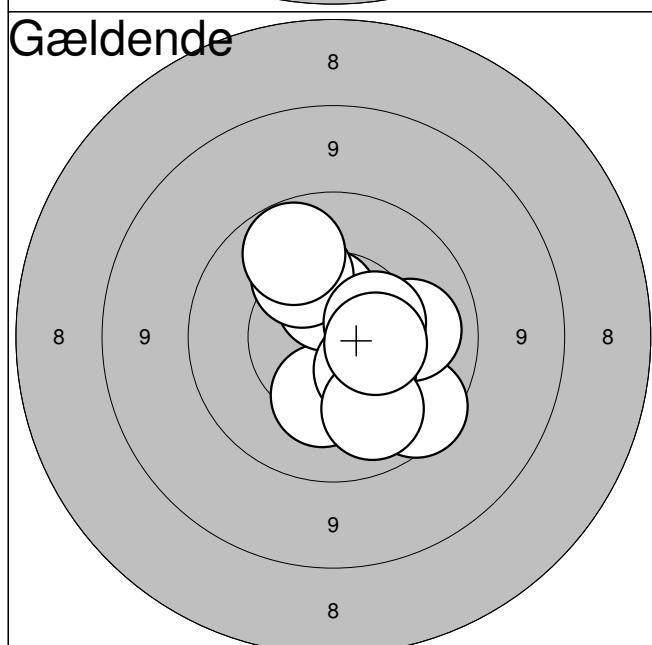

11:	10,3	↘
12:	10,6	↑
13:	9,8	↘
14:	10,1	→
15:	10,2	↗
16:	10,0	↗
17:	10,5	↘
18:	10,5	→
19:	10,1	↘
20:	10,5	→
<b>Serie:</b>		<b>99,0</b>
<b>Sum:</b>		<b>198,0</b>



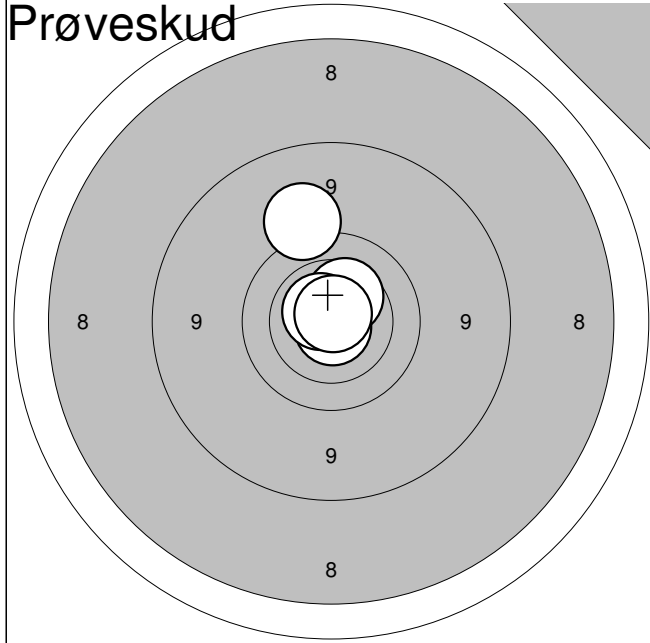

1:	10,8*	↓
2:	10,4	↗
3:	10,7*	↗
4:	9,4	↗
5:	10,8*	↗

<b>Serie:</b>	<b>49,0</b>
<b>Sum:</b>	<b>0,0</b>

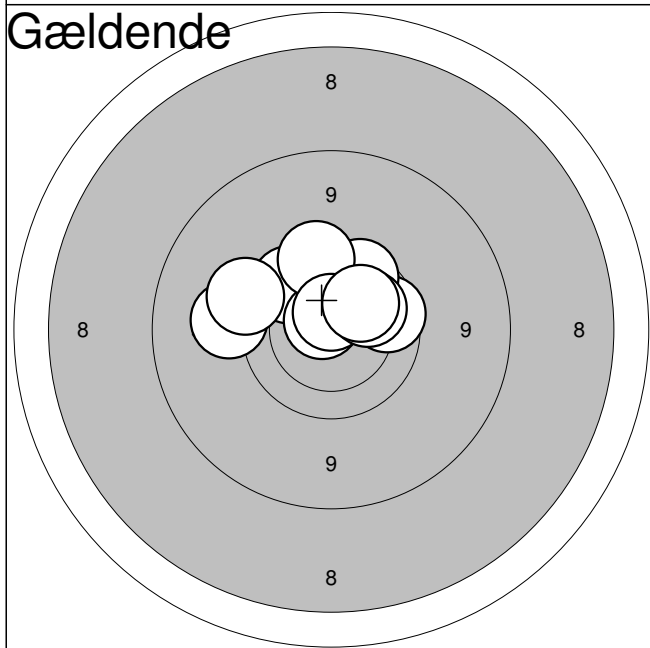

1:	9,4	←
2:	9,8	↗
3:	9,5	←
4:	9,9	→
5:	10,7*	↗
6:	9,9	↗
7:	9,7	↗
8:	10,6*	↗
9:	10,1	↗
10:	10,2	↗

<b>Serie:</b>	<b>94,0</b>
<b>Sum:</b>	<b>94,0</b>

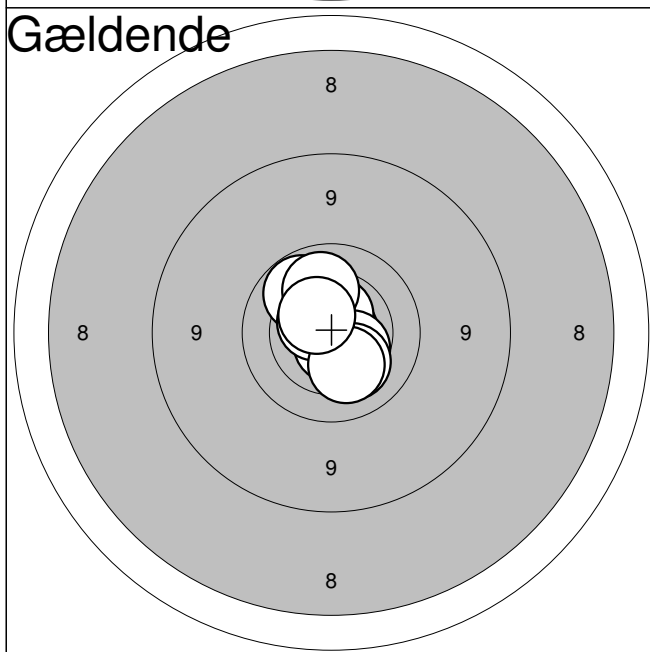

11:	10,8*	→
12:	10,0	↗
13:	10,6*	↗
14:	10,7*	↓
15:	10,4	↓
16:	10,2	↓
17:	10,6*	↗
18:	10,3	↓
19:	10,1	↗
20:	10,5*	↗

<b>Serie:</b>	<b>100,0</b>
<b>Sum:</b>	<b>194,0</b>

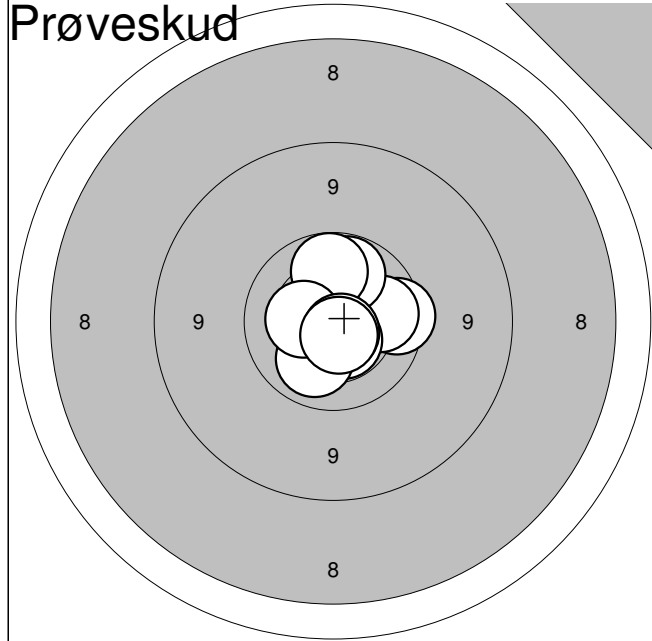

1:	9,8	→
2:	10,0	→
3:	10,0	↑
4:	10,0	↑
5:	10,5*	↓
6:	10,1	↓
7:	10,4	←
8:	10,7*	↓
9:	10,6*	↓

<b>Serie:</b>	<b>89,0</b>
<b>Sum:</b>	<b>0,0</b>

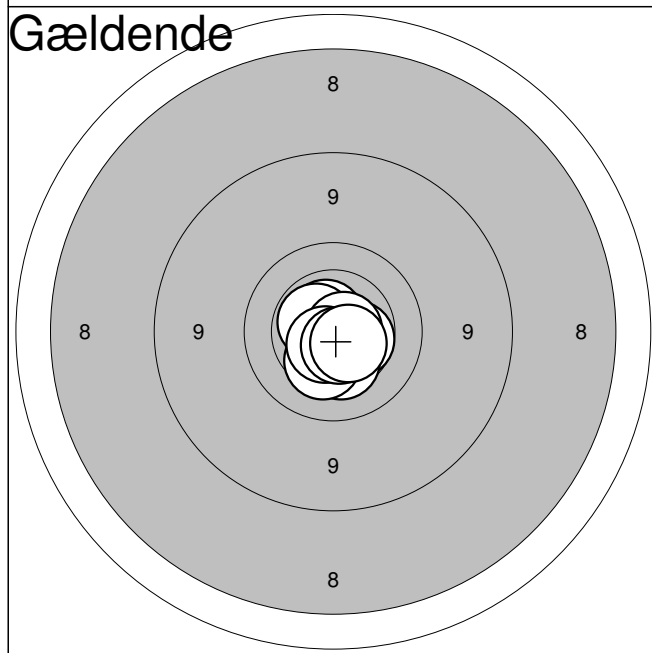

1:	10,7*	↑
2:	10,6*	↑
3:	10,5	→
4:	10,5*	↓
5:	10,3	↓
6:	10,3	↓
7:	10,7*	→
8:	10,6*	↓
9:	10,6*	↓
10:	10,6*	↓

<b>Serie:</b>	<b>100,0</b>
<b>Sum:</b>	<b>100,0</b>

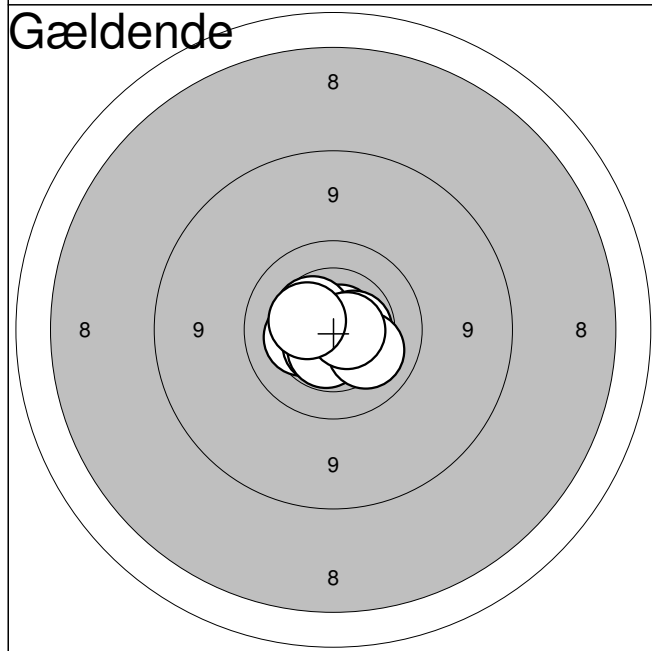

11:	10,5*	→
12:	10,3	←
13:	10,6*	↓
14:	10,8*	→
15:	10,5	↑
16:	10,5*	→
17:	10,5*	↓
18:	10,2	↓
19:	10,7*	→
20:	10,4	←

<b>Serie:</b>	<b>100,0</b>
<b>Sum:</b>	<b>200,0</b>

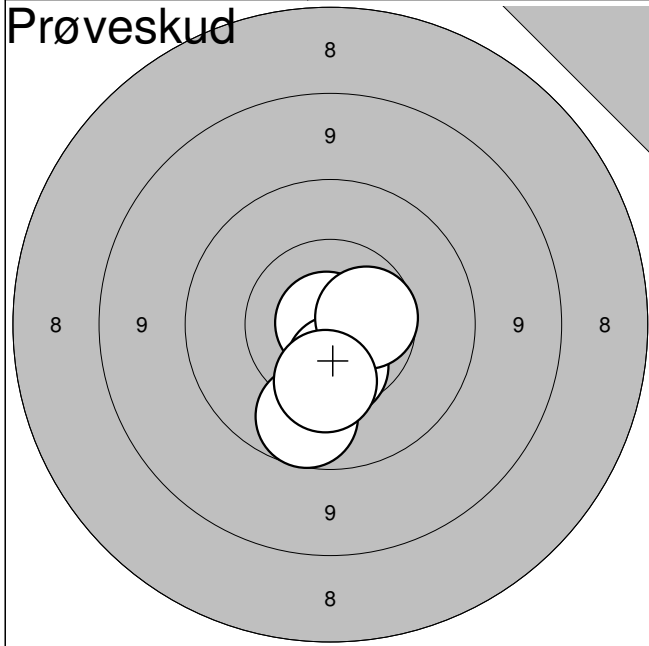

1:	10,9*	←
2:	10,5	↓
3:	9,9	↓
4:	10,6	→
5:	10,3	↓

**Serie: 49,0**

**Sum: 0,0**

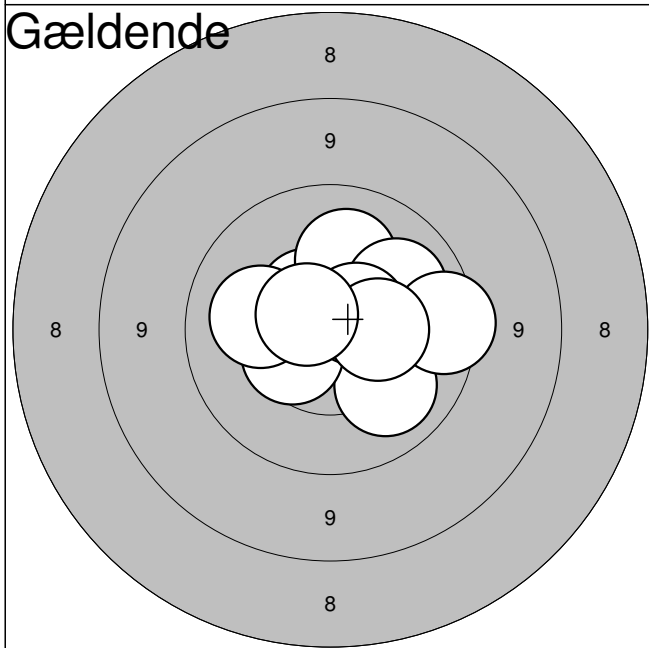

1:	10,6	↖
2:	10,2	↑
3:	10,1	↗
4:	10,1	↓
5:	9,7	→
6:	10,5	←
7:	10,6*	↗
8:	10,4	→
9:	10,2	←
10:	10,7*	↖

**Serie: 99,0**

**Sum: 99,0**

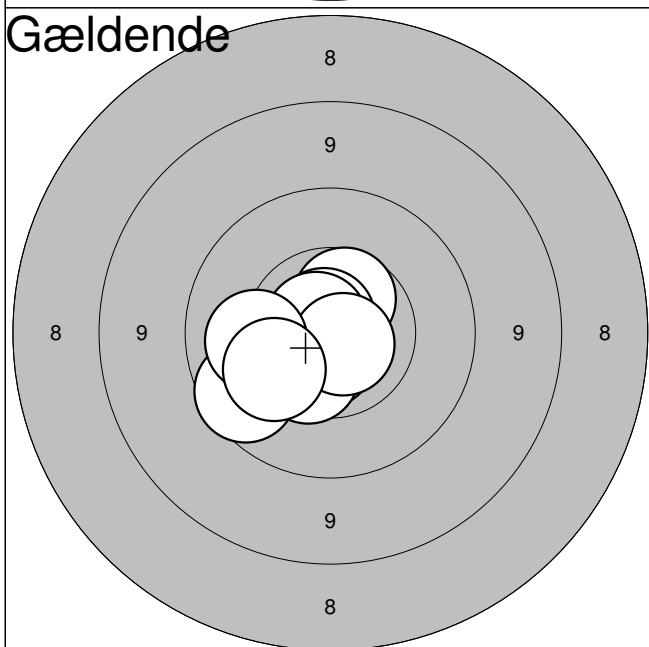

11:	10,6	↓
12:	10,7*	↓
13:	10,6	↗
14:	10,8*	↗
15:	10,8*	↗
16:	9,9	←
17:	10,5	↓
18:	10,8*	↓
19:	10,2	←
20:	10,2	↖

**Serie: 99,0**

**Sum: 198,0**

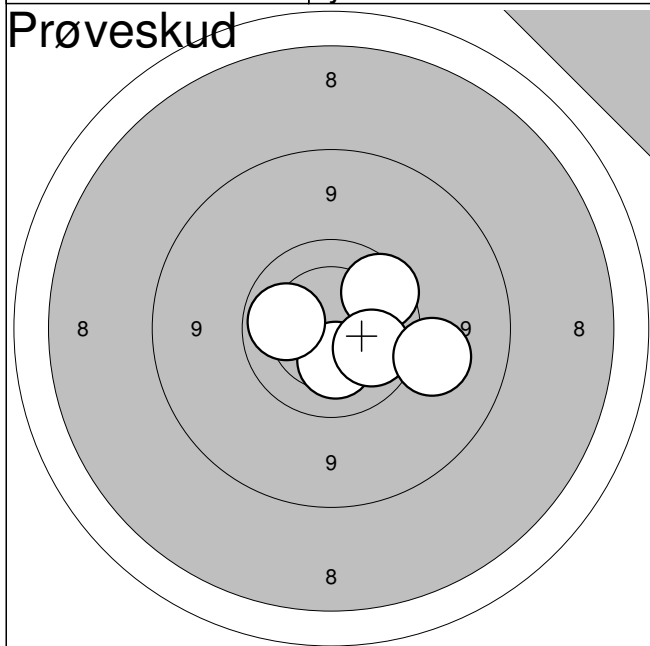

1:	10,3	↓
2:	9,8	↗
3:	10,1	←
4:	10,1	↘
5:	9,3	↘

<b>Serie:</b>	<b>48,0</b>
<b>Sum:</b>	<b>0,0</b>

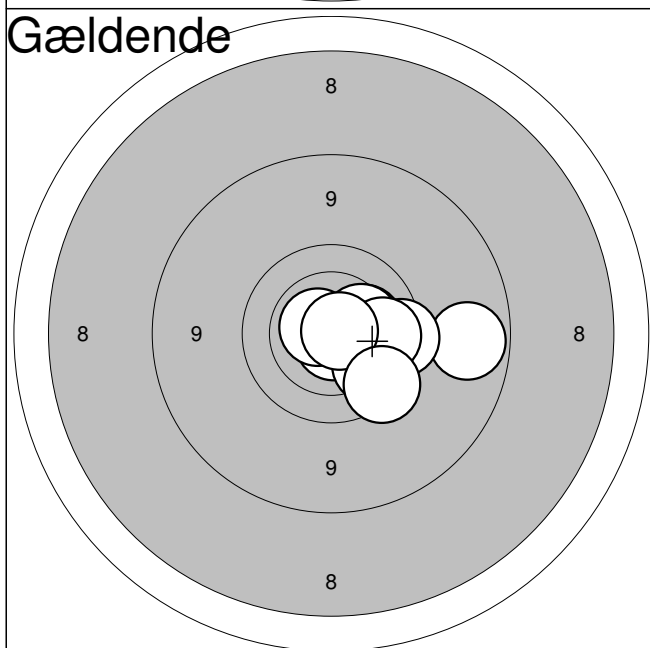

1:	9,0	→
2:	9,7	→
3:	10,8*	↓
4:	10,7*	↖
5:	10,0	↘
6:	10,3	→
7:	10,3	→
8:	9,9	→
9:	10,8*	→
10:	9,7	↓

<b>Serie:</b>	<b>96,0</b>
<b>Sum:</b>	<b>96,0</b>

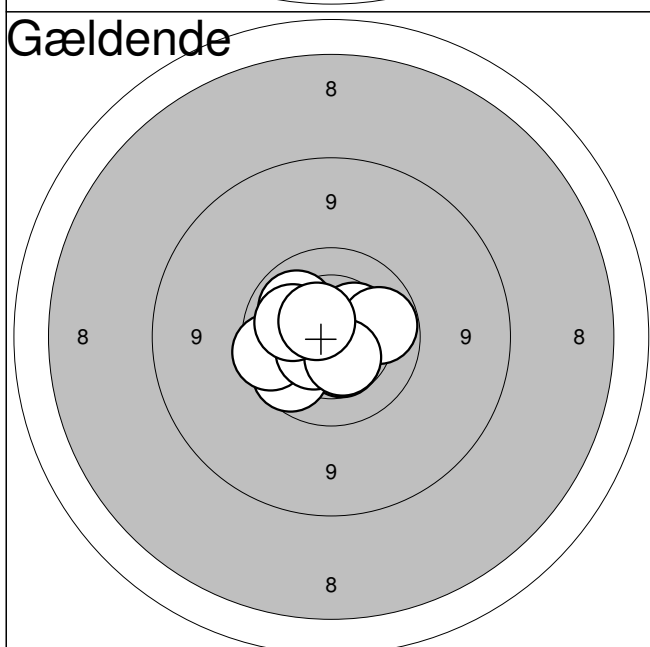

11:	10,5	↓
12:	9,9	↓
13:	10,1	↗
14:	10,4	↗
15:	9,8	←
16:	10,0	→
17:	10,5*	↓
18:	10,5	↓
19:	10,2	↖
20:	10,5*	↗

<b>Serie:</b>	<b>98,0</b>
<b>Sum:</b>	<b>194,0</b>

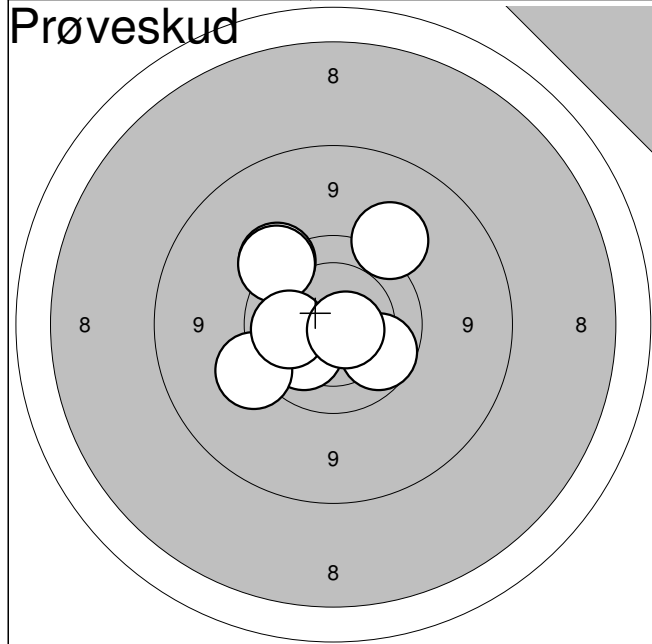

1:	10,2	↙
2:	9,6	↗
3:	9,6	↗
4:	9,9	↘
5:	9,5	↙
6:	9,4	↗
7:	10,1	↙
8:	10,7*	↘

<b>Serie:</b>	<b>75,0</b>
<b>Sum:</b>	<b>0,0</b>

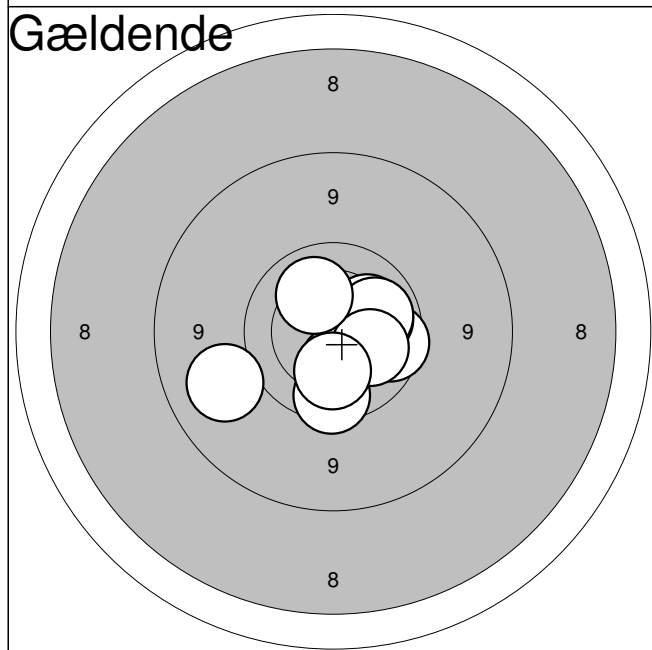

1:	9,9	→
2:	10,2	↗
3:	10,3	↓
4:	10,1	→
5:	10,1	→
6:	9,2	↙
7:	10,2	→
8:	9,8	↓
9:	10,2	↓
10:	10,2	↗

<b>Serie:</b>	<b>97,0</b>
<b>Sum:</b>	<b>97,0</b>

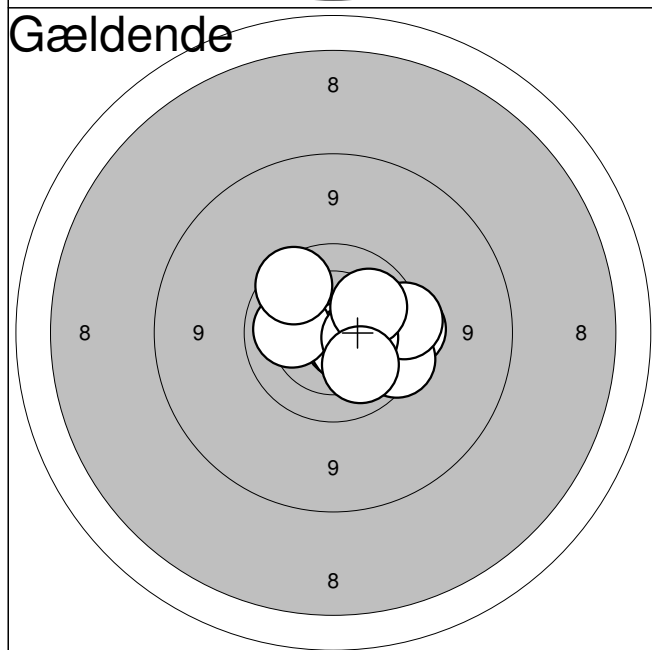

11:	10,7*	↘
12:	10,6*	↘
13:	9,7	→
14:	10,1	↙
15:	9,7	↘
16:	9,7	→
17:	10,4	→
18:	10,1	↗
19:	9,8	↗
20:	10,1	↘

<b>Serie:</b>	<b>96,0</b>
<b>Sum:</b>	<b>193,0</b>

Mou & Omegns Skf.

BK4

Jyllandsstævne 2011 - riffel

Aalborg Skyttekreds

Prøveskud

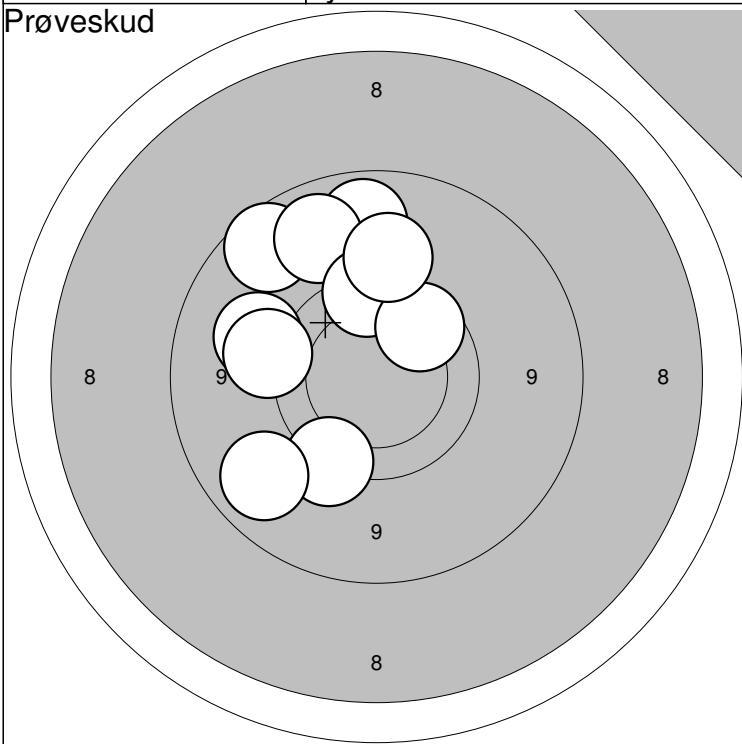

Prøveskud

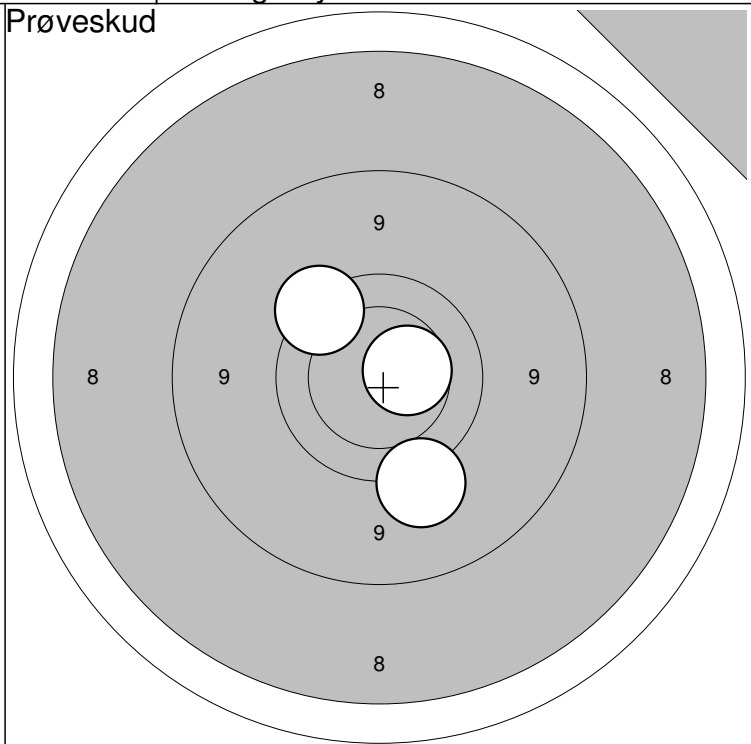

1: 9,0 ↑  
2: 8,9 ↗  
3: 9,1 ↗  
4: 9,3 ↖  
5: 9,7 ↑

6: 9,4 ←  
7: 9,6 ↓  
8: 9,9 ↗  
9: 9,1 ↖  
10: 9,4 ↑

Serie: 89,0

Sum: 0,0

11: 9,7 ↗  
12: 9,4 ↓  
13: 10,5 →

Serie: 28,0

Sum: 0,0

Gældende

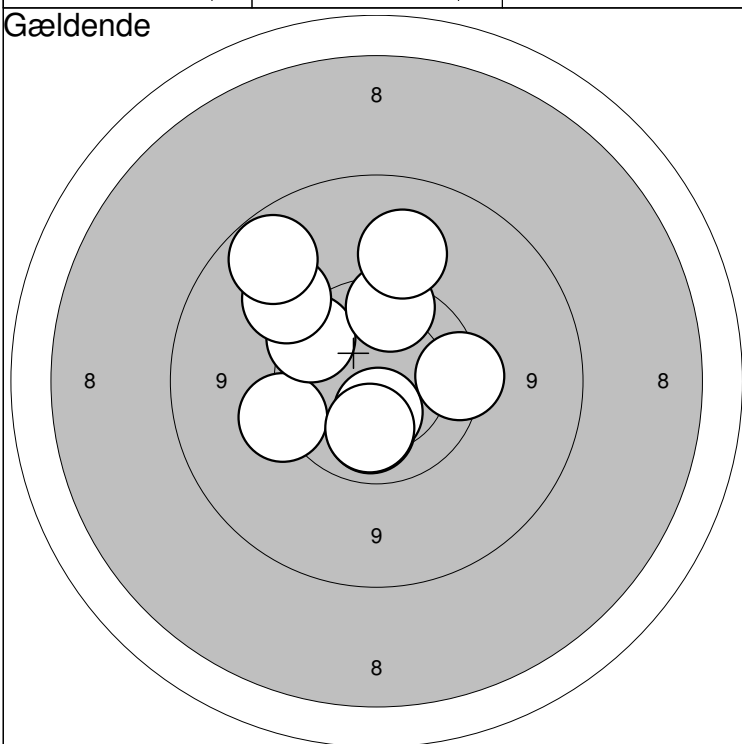

Gældende

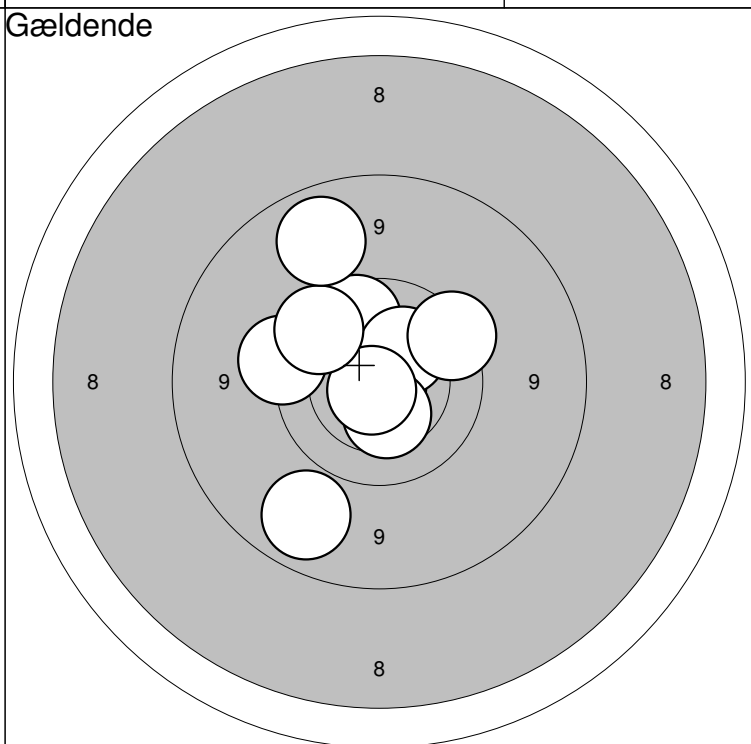

1: 10,1 ↓  
2: 9,5 ↖  
3: 9,8 ↖  
4: 9,8 ↑  
5: 9,3 ↑

6: 10,4 ↓  
7: 9,3 ↗  
8: 10,1 ↓  
9: 9,7 →  
10: 9,0 ↗

Serie: 93,0

Sum: 93,0

11: 9,9 ↗  
12: 9,1 ↓  
13: 10,8\* ↓  
14: 10,3 ↗  
15: 10,4 ↓

16: 9,6 ←  
17: 10,8\* ↓  
18: 9,8 ↖  
19: 9,1 ↗  
20: 9,7 ↗

Serie: 94,0

Sum: 187,0

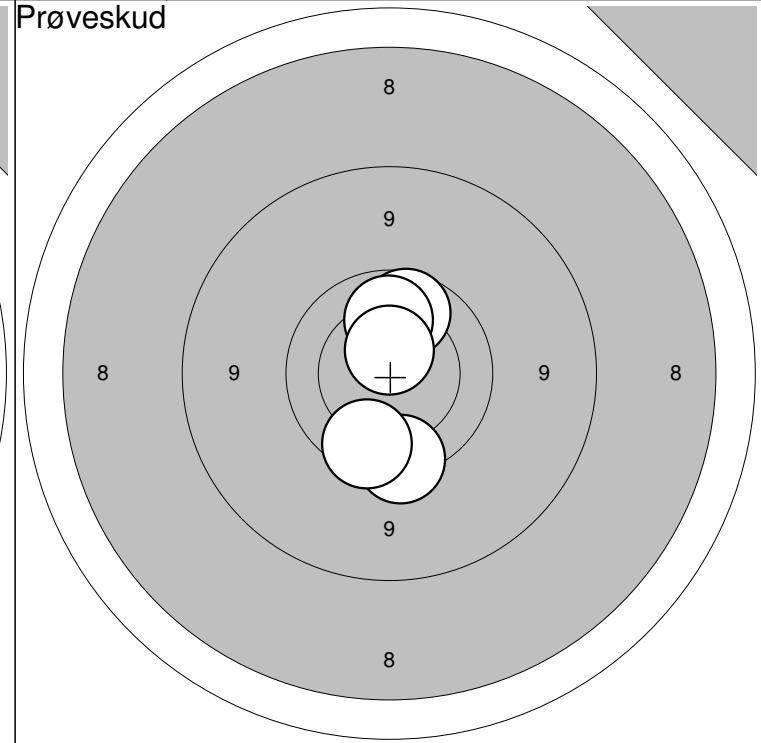
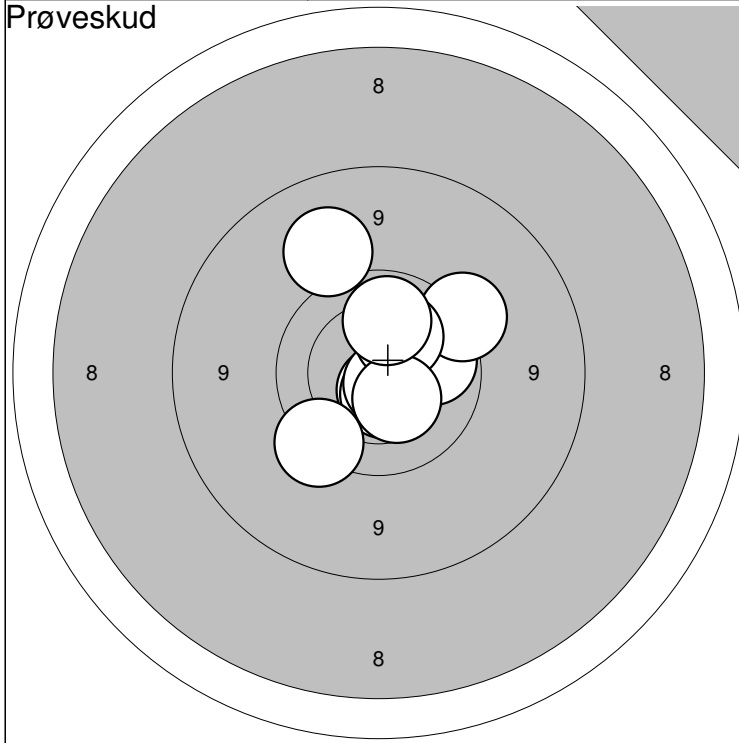

1: 9,3 ↗	6:10,7* ↘	Serie: 97,0
2:10,6* ↘	7:10,2 ↗	
3:10,0 →	8:10,4 ↘	Sum: 0,0
4: 9,5 ↗	9: 9,6 ↘	
5:10,6* ↘	10:10,1 ↗	

11: 9,9 ↗	Serie: 47,0
12: 9,7 ↘	
13: 9,8 ↘	Sum: 0,0
14:10,0 ↗	
15:10,6* ↗	

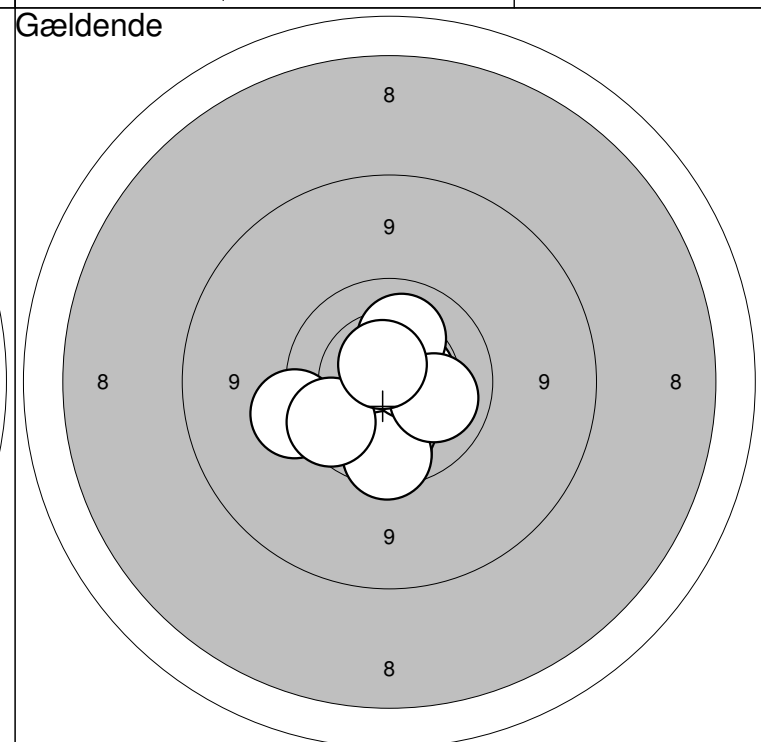
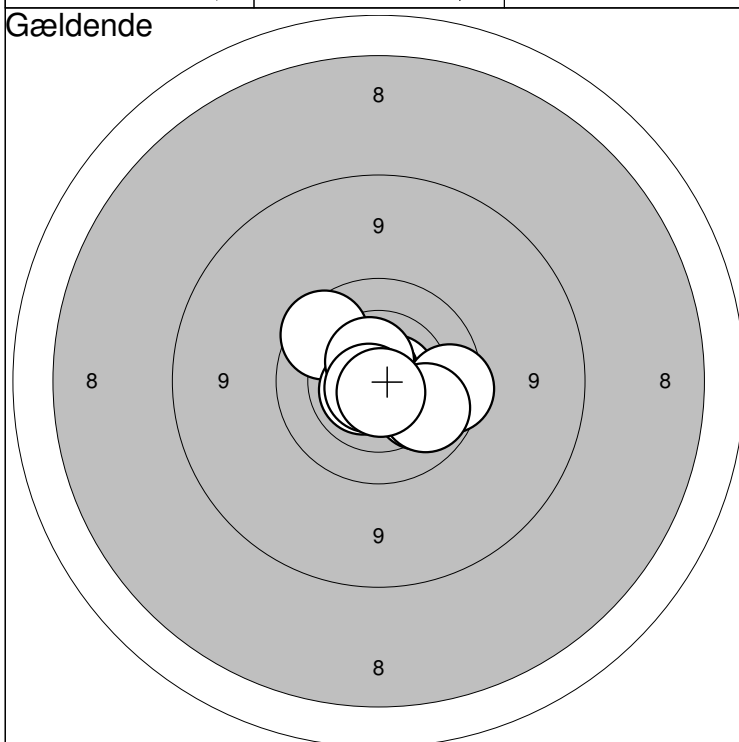

1: 9,8 ↗	6: 9,8 →	Serie: 98,0
2:10,7* →	7:10,6* ↗	
3:10,1 ↘	8:10,0 ↘	Sum: 98,0
4:10,8* ↗	9:10,7* ↖	
5:10,7* ↖	10:10,8* ↘	

11: 9,8 ↘	16:10,6* →	Serie: 96,0
12:10,4 ↘	17: 9,8 ↖	
13: 9,6 ↖	18:10,2 ↗	Sum: 194,0
14:10,2 ↘	19:10,1 →	
15: 9,8 ↘	20:10,6* ↗	

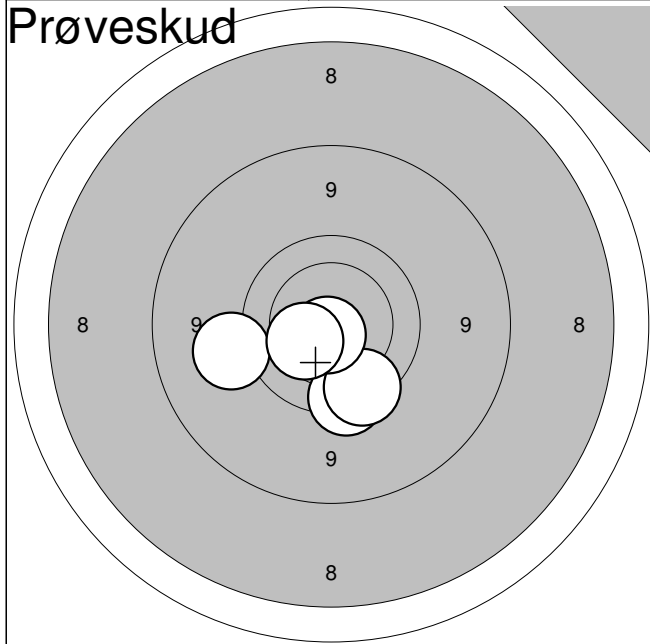

1:	9,7	↓
2:	9,7	↓
3:	9,4	←
4:	10,7*	↓
5:	10,3	↙

<b>Serie:</b>	<b>47,0</b>
<b>Sum:</b>	<b>0,0</b>

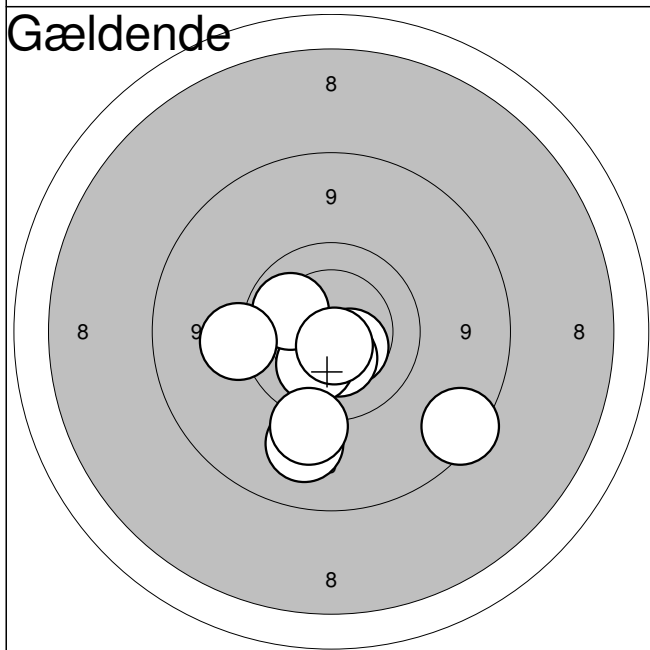

1:	10,5	↘
2:	9,2	↓
3:	10,4	↘
4:	8,8	↘
5:	10,4	↓
6:	10,2	↓
7:	9,4	↓
8:	10,1	↗
9:	9,5	←
10:	10,6*	↓

<b>Serie:</b>	<b>95,0</b>
<b>Sum:</b>	<b>95,0</b>

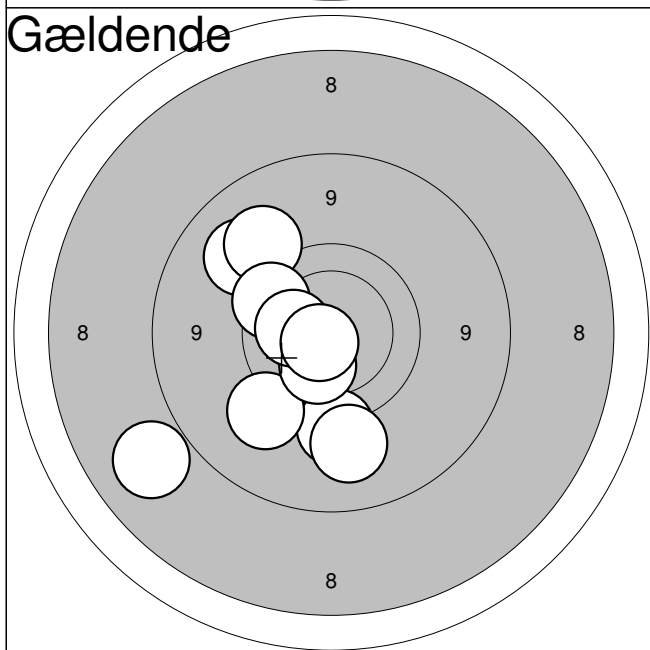

11:	9,2	↗
12:	9,5	↓
13:	9,4	↘
14:	8,4	←
15:	9,3	↓
16:	10,3	↓
17:	9,3	↗
18:	9,8	↗
19:	10,2	←
20:	10,6*	↘

<b>Serie:</b>	<b>92,0</b>
<b>Sum:</b>	<b>187,0</b>



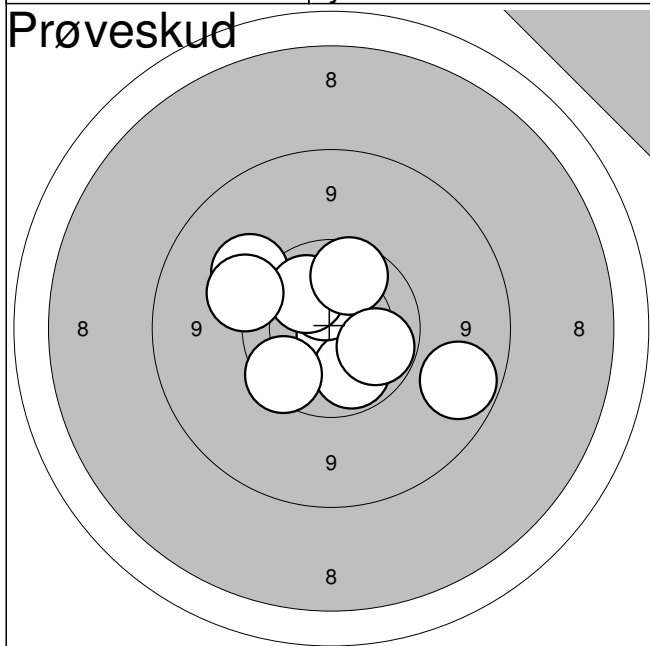

1:	9,0	↘
2:	9,4	↗
3:	10,8*	↘
4:	10,0	↘
5:	10,4	↗
6:	10,1	↗
7:	9,5	↖
8:	9,9	↗
9:	9,8	↘
10:	10,0	↘

Serie:	<b>95,0</b>
--------	-------------

Sum:	<b>0,0</b>
------	------------

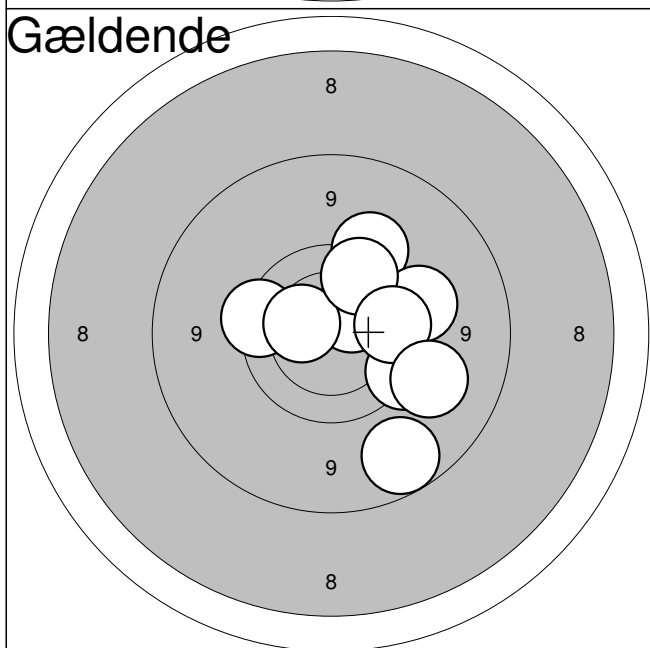

1:	9,7	←
2:	10,4	↗
3:	9,5	↗
4:	9,0	↘
5:	9,6	↘
6:	10,3	↖
7:	9,5	→
8:	9,8	↗
9:	9,8	→
10:	9,3	↘

Serie:	<b>92,0</b>
--------	-------------

Sum:	<b>92,0</b>
------	-------------

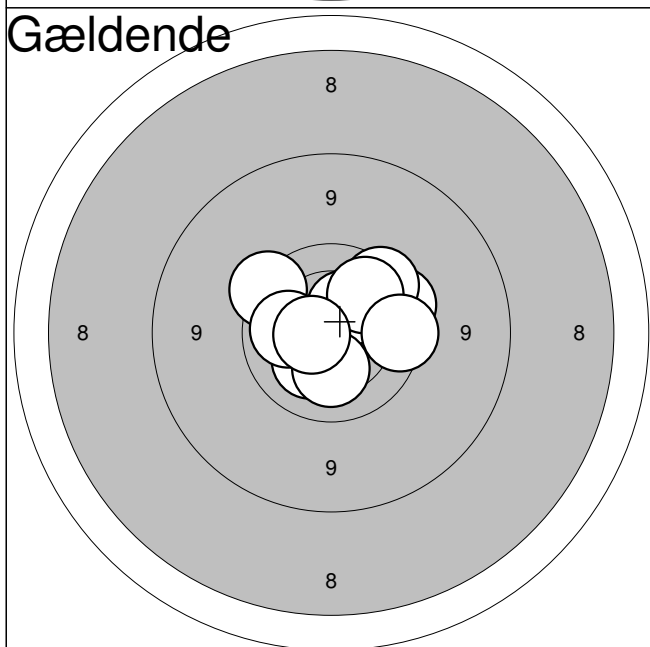

11:	9,7	↖
12:	9,7	→
13:	9,8	↗
14:	10,4	↗
15:	10,3	↘
16:	10,0	↗
17:	10,1	←
18:	10,2	↓
19:	10,6*	←
20:	9,7	→

Serie:	<b>96,0</b>
--------	-------------

Sum:	<b>188,0</b>
------	--------------

Mou & Omegns Skf.

ÅK3

Jyllandsstævne 2011 - riffel

Aalborg Skyttekreds

**Prøveskud**

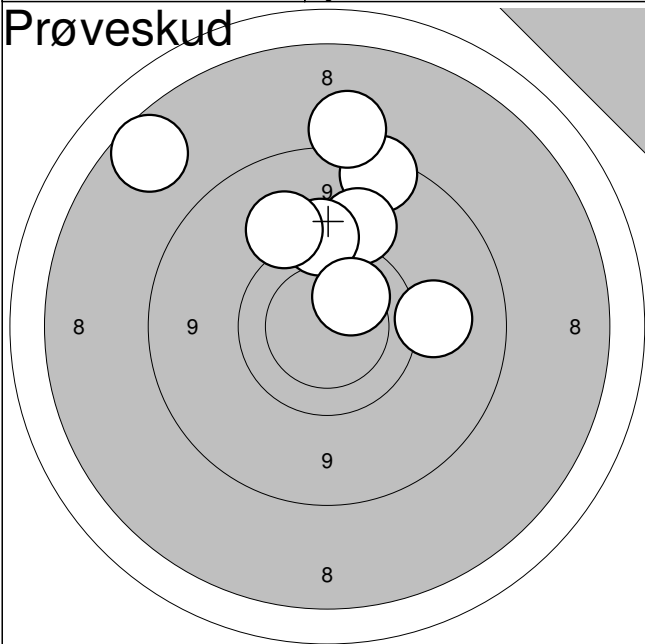

1:	8,8	↑
2:	9,4	↑
3:	9,5	↑
4:	9,3	→
5:	9,3	↑
6:	8,2	↖
7:	8,5	↑
8:	10,2	↗

**Serie: 70,0**

**Sum: 0,0**

**Gældende**

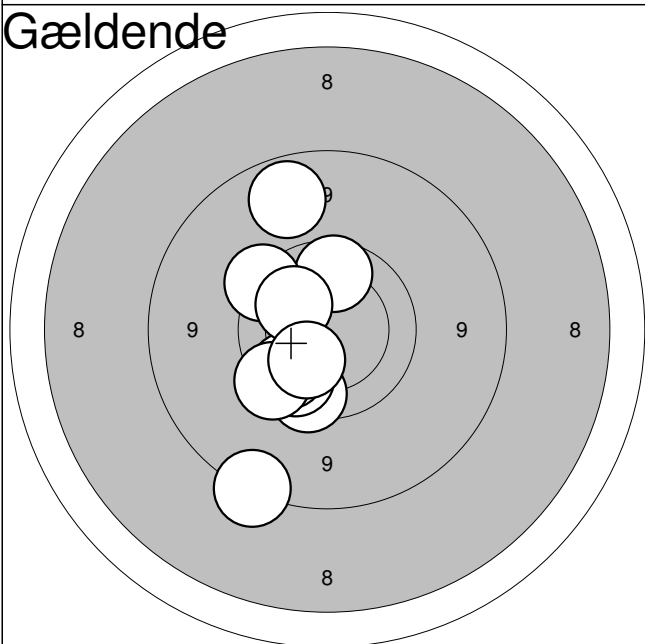

1:	9,0	↑
2:	9,9	↑
3:	9,6	↖
4:	9,8	↓
5:	8,7	↓
6:	9,9	↓
7:	9,9	↖
8:	10,1	↖
9:	9,7	↖
10:	10,2	↓

**Serie: 91,0**

**Sum: 91,0**

**Gældende**

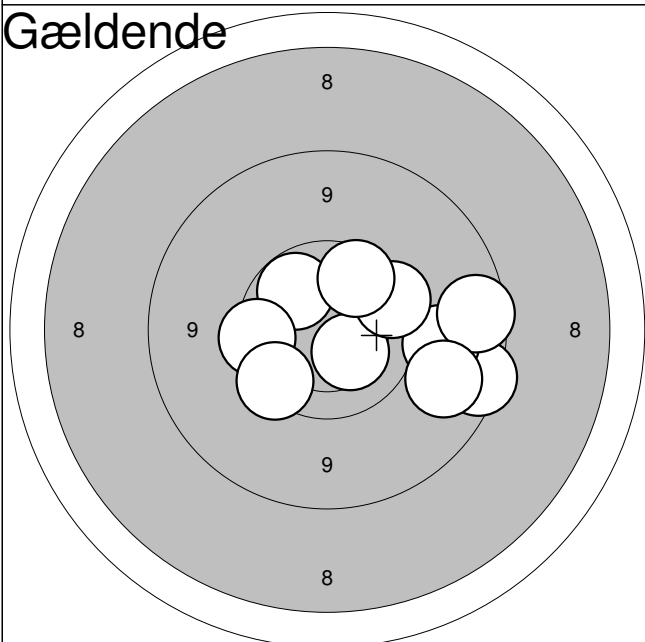

11:	10,0	↗
12:	9,7	←
13:	8,8	→
14:	9,2	→
15:	10,3	↓
16:	8,9	→
17:	9,7	↗
18:	9,9	↑
19:	9,7	↖
20:	9,1	→

**Serie: 90,0**

**Sum: 181,0**

Mou &amp; Omegns Skf.

BK3

Jyllandsstævne 2011 - riffel

Aalborg Skyttekreds

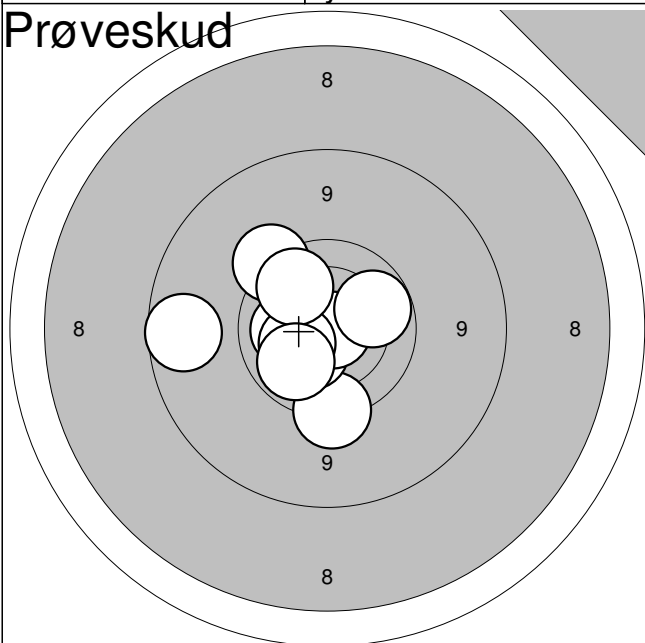
**Prøveskud**

1:	8,9	←
2:	9,6	↓
3:	9,6	↗
4:	10,4	↓
5:	10,2	←
6:	10,8*	→
7:	10,3	←
8:	10,0	→
9:	9,9	↗
10:	10,1	↓

Serie: 95,0

Sum: 0,0

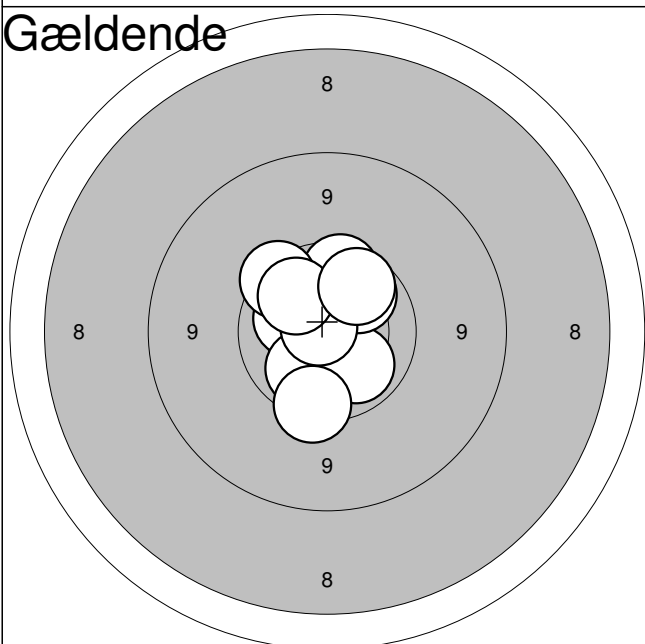
**Gældende**

1:	10,2	←
2:	10,1	↓
3:	9,8	↑
4:	9,7	↗
5:	10,1	↓
6:	9,7	↓
7:	10,0	↗
8:	10,8*	↗
9:	10,0	↗
10:	9,9	↗

Serie: 96,0

Sum: 96,0

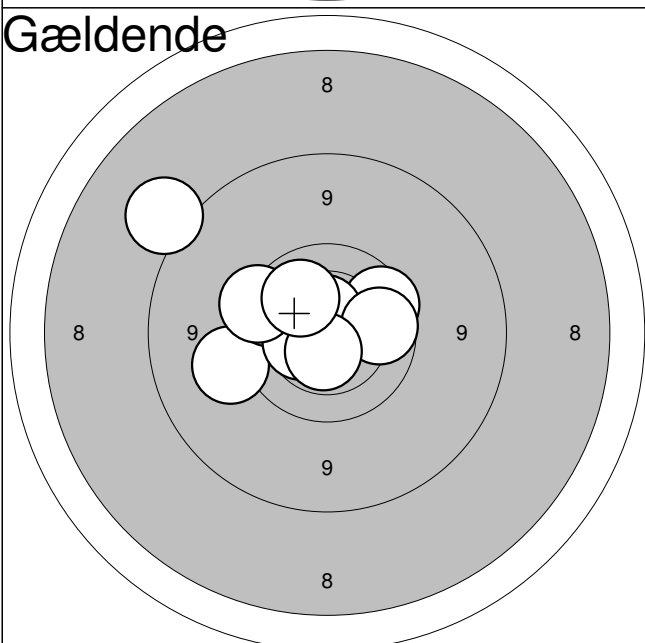
**Gældende**

11:	9,8	↗
12:	8,5	↗
13:	9,4	←
14:	10,6*	↑
15:	9,8	↗
16:	10,4	←
17:	9,7	↗
18:	9,9	→
19:	10,6*	↓
20:	10,1	↗

Serie: 93,0

Sum: 189,0

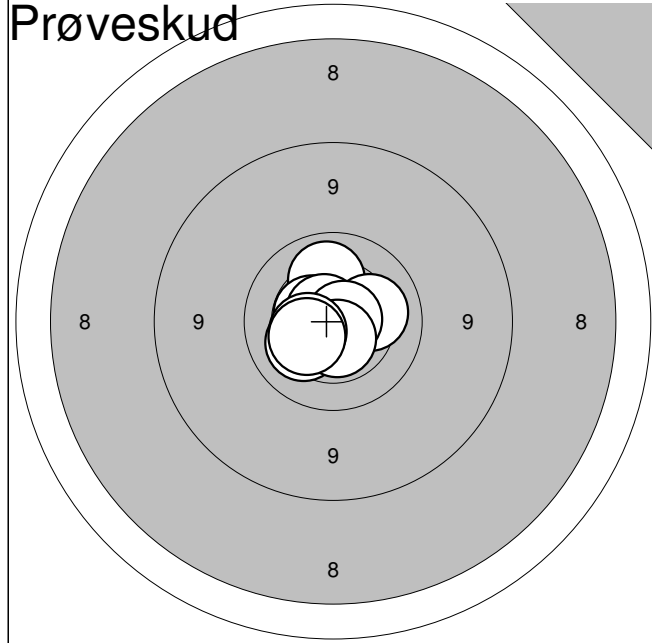

1:	10,1	↑
2:	10,2	↙
3:	10,5*	↖
4:	10,7*	↗
5:	10,2	→
6:	10,7*	→
7:	10,6*	↓
8:	10,4	↖
9:	10,4	↘

<b>Serie:</b>	<b>90,0</b>
<b>Sum:</b>	<b>0,0</b>

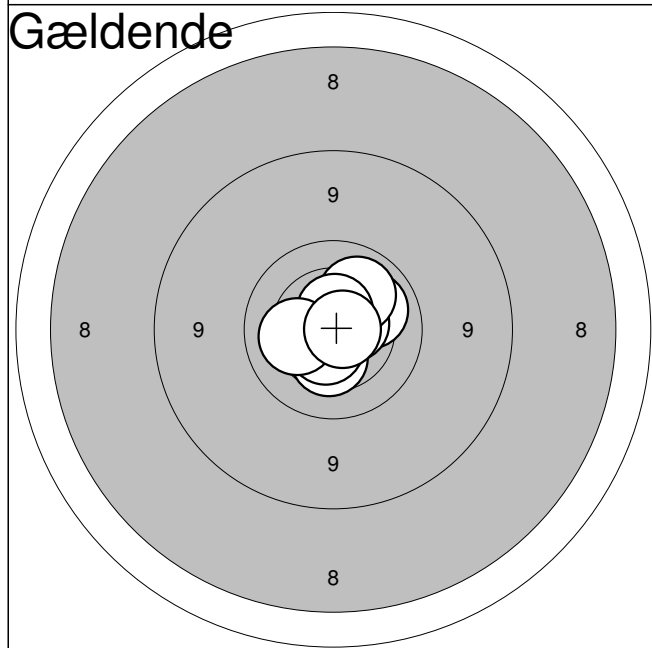

1:	10,4	↓
2:	10,8*	↖
3:	10,1	↗
4:	10,6*	→
5:	10,1	↗
6:	10,7*	↙
7:	10,6*	↑
8:	10,6*	↓
9:	10,2	↖
10:	10,8*	→

<b>Serie:</b>	<b>100,0</b>
<b>Sum:</b>	<b>100,0</b>

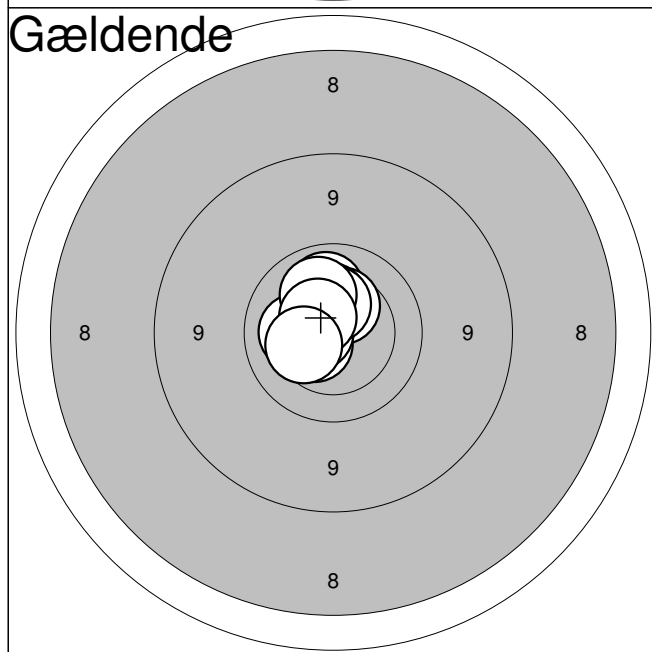

11:	10,1	↑
12:	10,4	↑
13:	10,5*	↙
14:	10,6*	↖
15:	10,2	↖
16:	10,3	↑
17:	10,4	↑
18:	10,2	↗
19:	10,5*	↗
20:	10,3	↖

<b>Serie:</b>	<b>100,0</b>
<b>Sum:</b>	<b>200,0</b>

Hold  
**42**

Bane  
**2**

# Dennis Nielsen

Ulsted Skf.

2

Jyllandsstævne 2011 - riffel

Aalborg Skyttekreds

Prøveskud

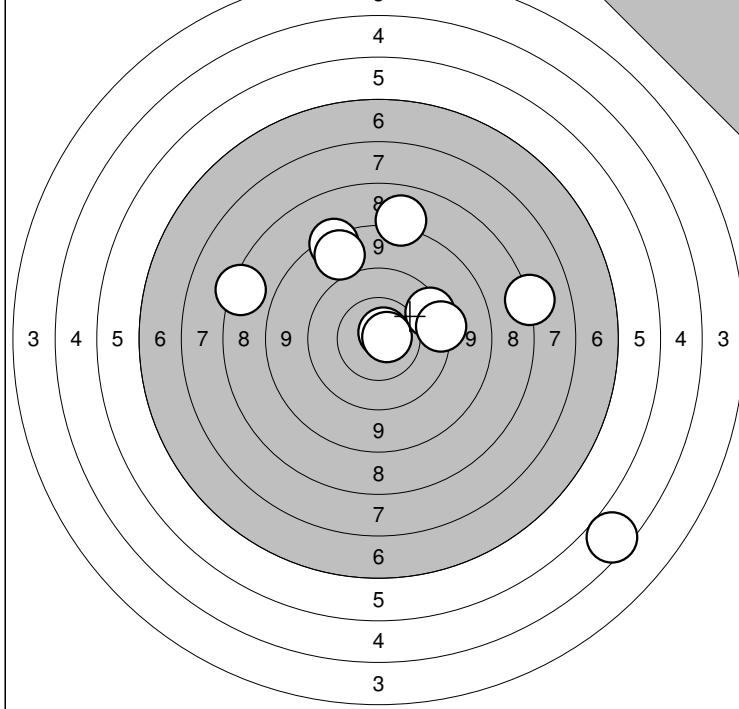

Prøveskud

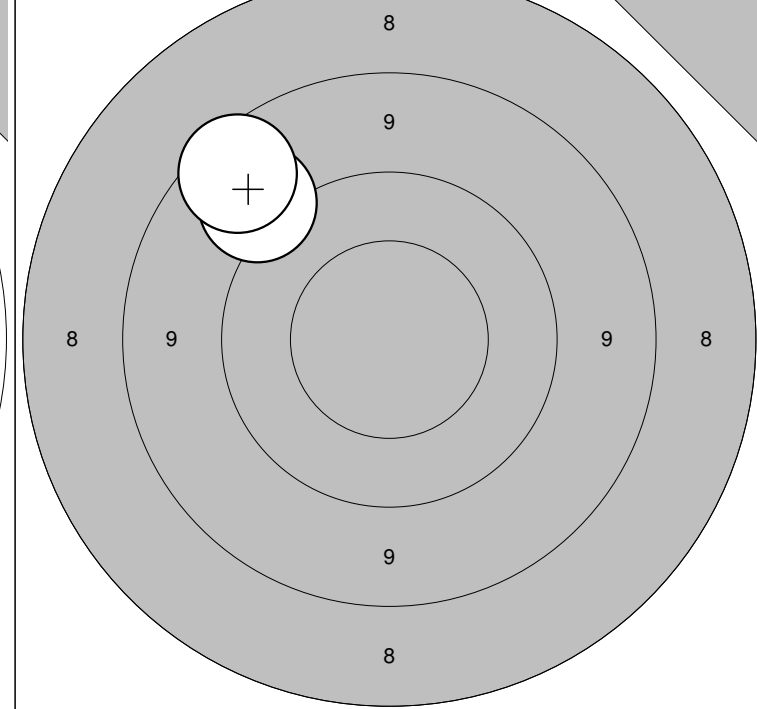

1: 8,6 ↗  
 2: 8,2 ↑  
 3: 9,7 →  
 4: 3,8 ↘  
 5: 7,3 →

6:10,8\* ↗  
 7: 9,5 →  
 8:10,8\* →  
 9: 7,6 ←  
 10: 8,9 ↗

Serie: 79,0  
 Sum: 0,0

11: 9,1 ↗  
 12: 8,8 ↗

Serie: 17,0  
 Sum: 0,0

Gældende

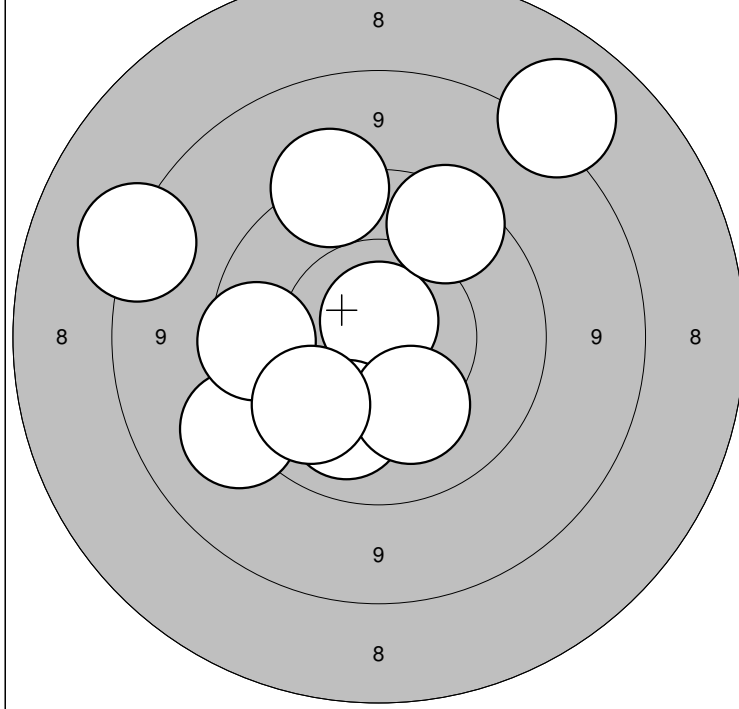

Gældende

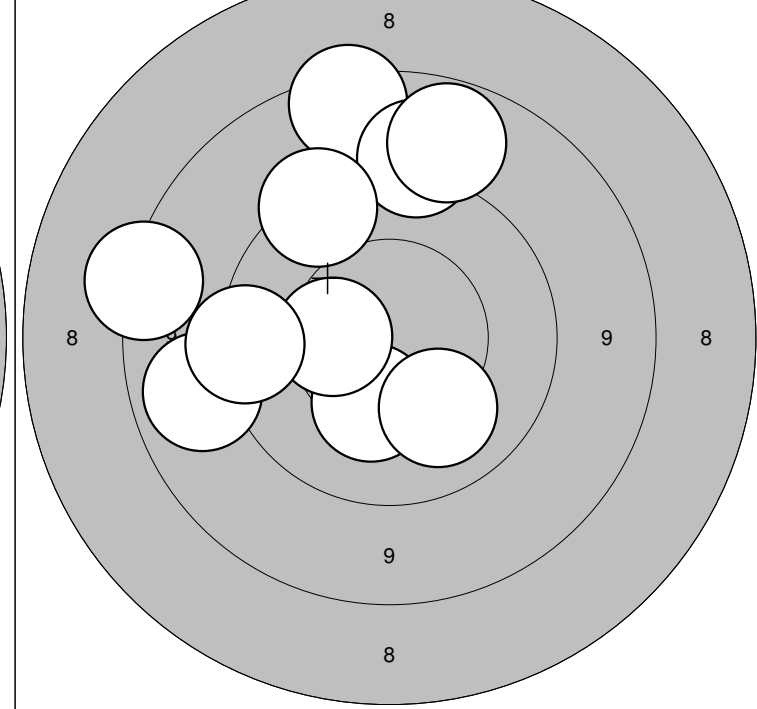

1:10,8\* ↑  
 2:10,1 ↓  
 3: 8,4 ←  
 4:10,3 ↓  
 5: 8,2 ↗

6: 9,5 ↑  
 7: 9,4 ↙  
 8: 9,8 ←  
 9: 9,7 ↗  
 10:10,1 ↙

Serie: 92,0  
 Sum: 92,0

11: 8,7 ↑  
 12: 9,2 ↑  
 13: 9,0 ↑  
 14: 9,6 ↗  
 15: 9,1 ←

16:10,3 ↓  
 17:10,4 ←  
 18: 9,6 ←  
 19:10,2 ↓  
 20: 8,5 ←

Serie: 91,0  
 Sum: 183,0

Hold  
**42**

Bane  
**3**

# Viggo Kristensen

Ulsted Skf.

V1

Jyllandsstævne 2011 - riffel

Aalborg Skyttekreds

Prøveskud

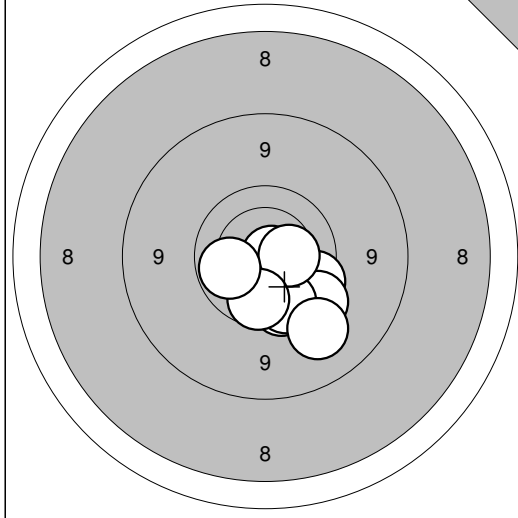

- 1: 9,7 ↘
- 2: 10,5\* ↘
- 3: 9,8 ↘
- 4: 9,5 ↘
- 5: 9,8 ↘
- 6: 9,3 ↘
- 7: 10,8\* →
- 8: 10,4 →
- 9: 9,9 ↓
- 10: 10,0 ←

Serie: 94,0  
Sum: 0,0

Prøveskud

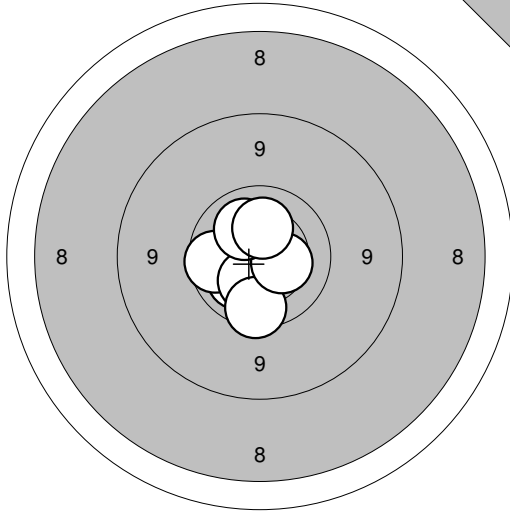

- 11: 10,4 ↘
- 12: 10,2 ↘
- 13: 10,6\* ↖
- 14: 10,4 ←
- 15: 9,9 ←
- 16: 10,3 ↓
- 17: 9,8 ↓
- 18: 10,4 →
- 19: 10,2 ↗
- 20: 10,3 ↑

Serie: 98,0  
Sum: 0,0

Prøveskud

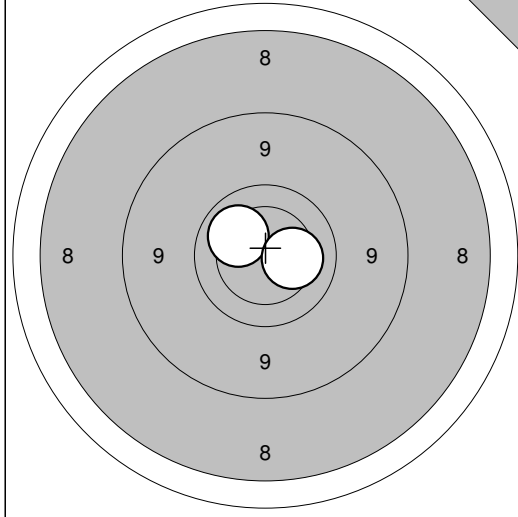

- 21: 10,1 ↗
- 22: 10,3 →

Serie: 20,0  
Sum: 0,0

Gældende

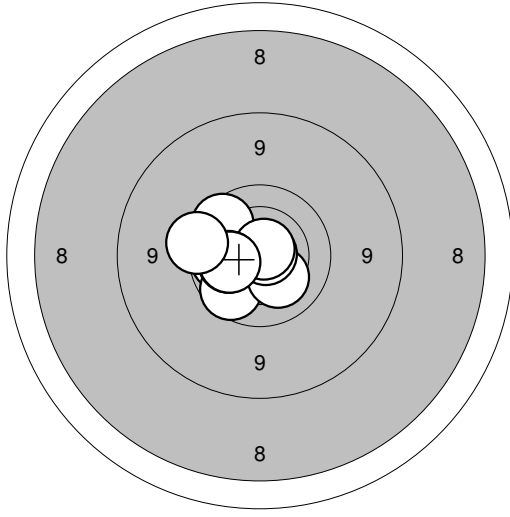

- 1: 10,3 ↘
- 2: 10,0 ←
- 3: 9,8 ↖
- 4: 9,9 ↘
- 5: 10,2 ↓
- 6: 10,8\* →
- 7: 10,8\* ↗
- 8: 10,2 ←
- 9: 10,2 ←
- 10: 9,6 ←

Serie: 97,0  
Sum: 97,0

Gældende

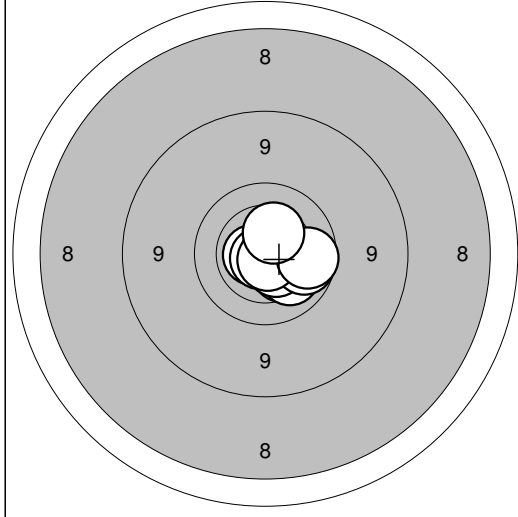

- 11: 10,7\* ←
- 12: 10,3 ↘
- 13: 10,8\* ↘
- 14: 10,8\* →
- 15: 10,2 ↘
- 16: 10,5\* ↘
- 17: 9,9 →
- 18: 10,8\* ↘
- 19: 9,9 →
- 20: 10,4 ↗

Serie: 98,0  
Sum: 195,0

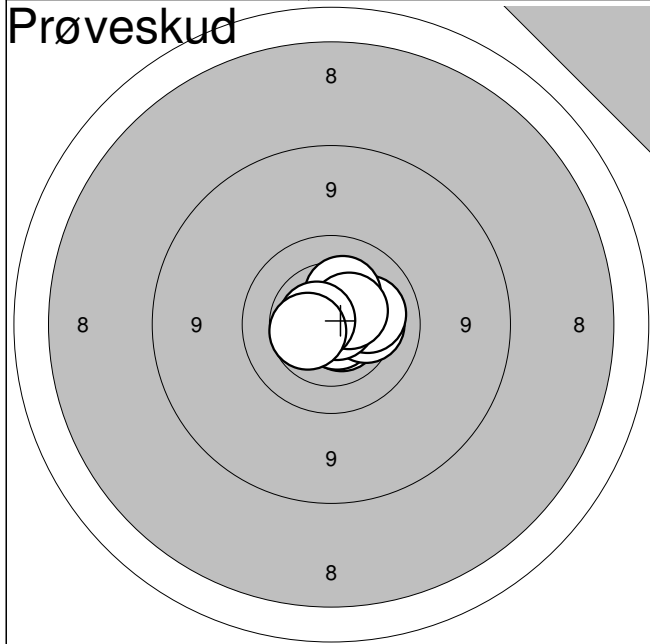

1:	10,7*	↘
2:	10,8*	↘
3:	10,3	→
4:	10,2	→
5:	10,8*	↗
6:	10,3	↑
7:	10,5*	↗
8:	10,7*	←
9:	10,5	←

<b>Serie:</b>	<b>90,0</b>
<b>Sum:</b>	<b>0,0</b>

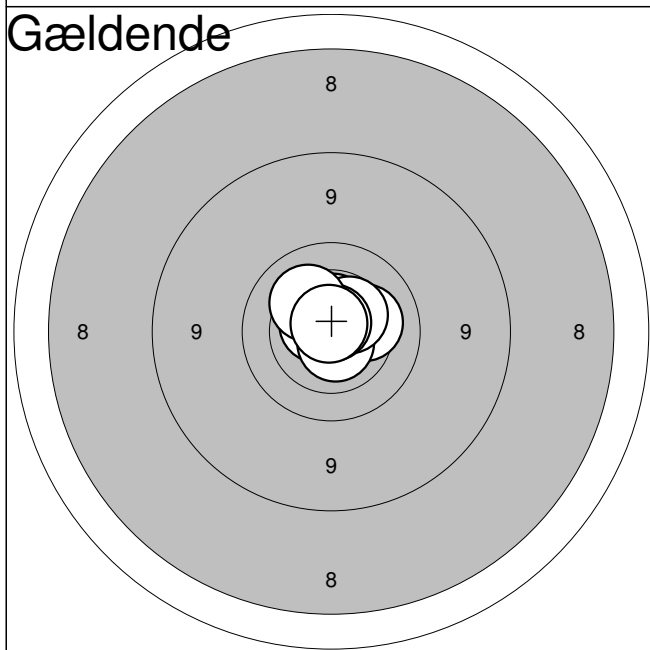

1:	10,6*	↑
2:	10,7*	↗
3:	10,7*	↖
4:	10,3	→
5:	10,6*	↑
6:	10,7*	↓
7:	10,5	↗
8:	10,8*	↑
9:	10,2	↗
10:	10,8*	↑

<b>Serie:</b>	<b>100,0</b>
<b>Sum:</b>	<b>100,0</b>

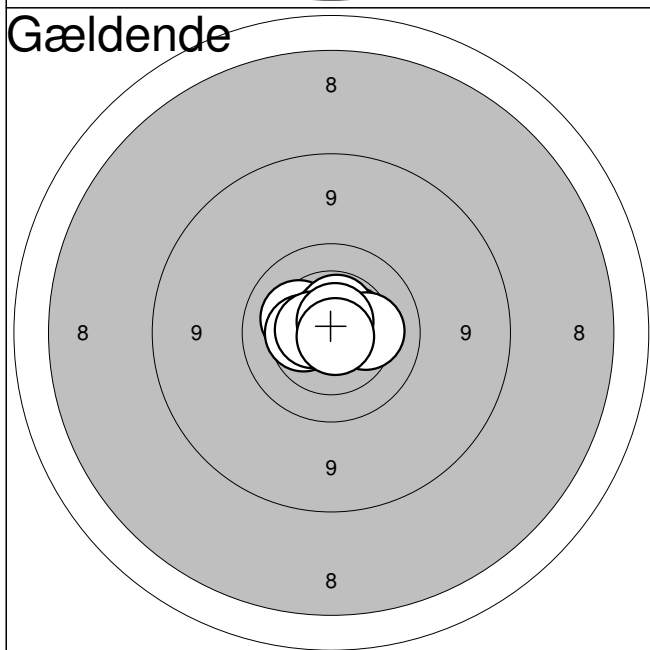

11:	10,3	←
12:	10,7*	↑
13:	10,8*	↖
14:	10,5*	→
15:	10,6*	↑
16:	10,4	←
17:	10,3	→
18:	10,6*	←
19:	10,7*	↑
20:	10,8*	↓

<b>Serie:</b>	<b>100,0</b>
<b>Sum:</b>	<b>200,0</b>

Hold  
**42**Bane  
**5****Jonas Martinsen**

Midtdjurs Skytteforening

BK2

Jyllandsstævne 2011 - riffel

Aalborg Skyttekreds

Prøveskud

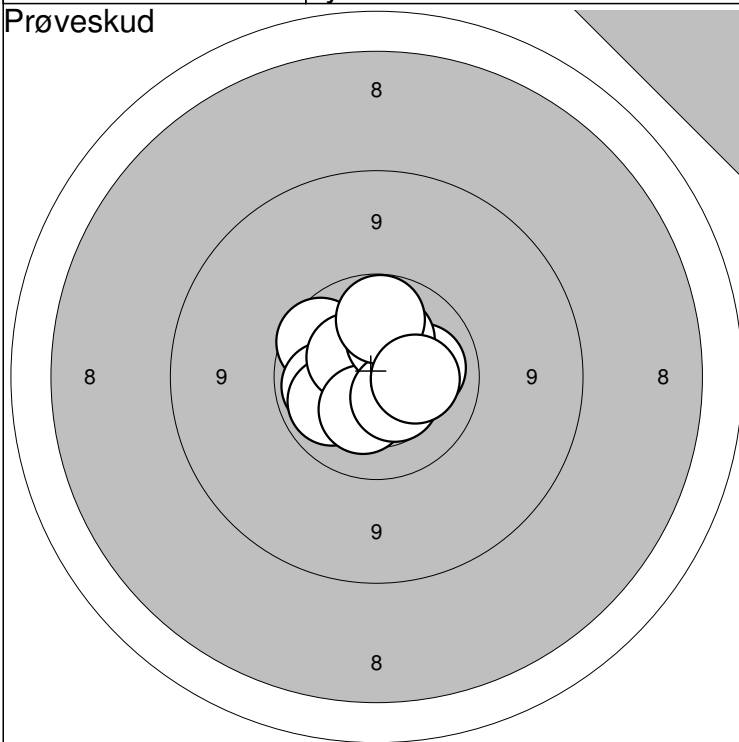

Prøveskud

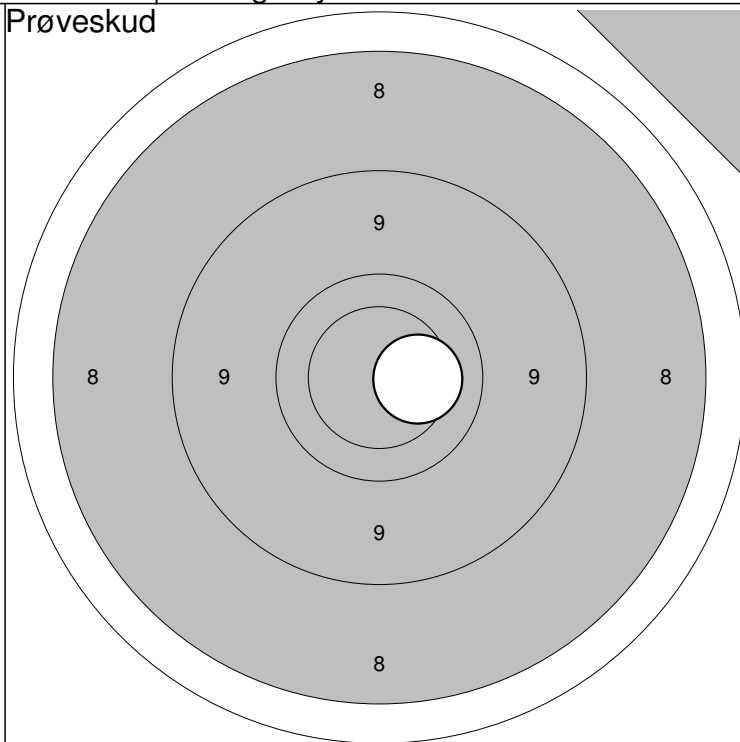

1: 9,9 ↗

2: 10,1 ←

3: 10,2 →

4: 10,1 ↙

5: 10,4 ↖

6: 10,4 ↘

7: 10,3 ↗

8: 10,5 ↘

9: 10,0 ↗

10: 10,3 →

Serie: 99,0

Sum: 0,0

11: 10,3 →

Serie: 10,0

Sum: 0,0

Gældende

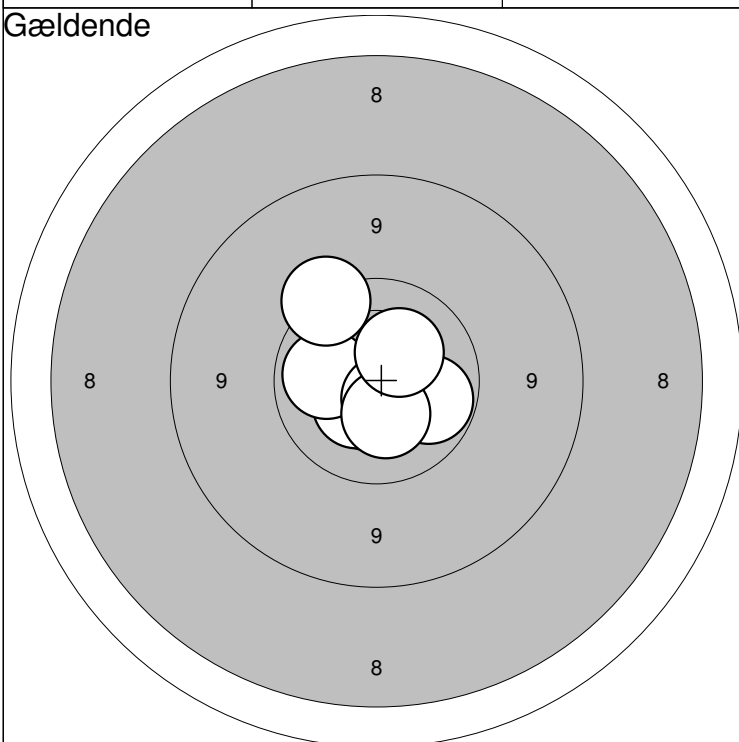

Gældende

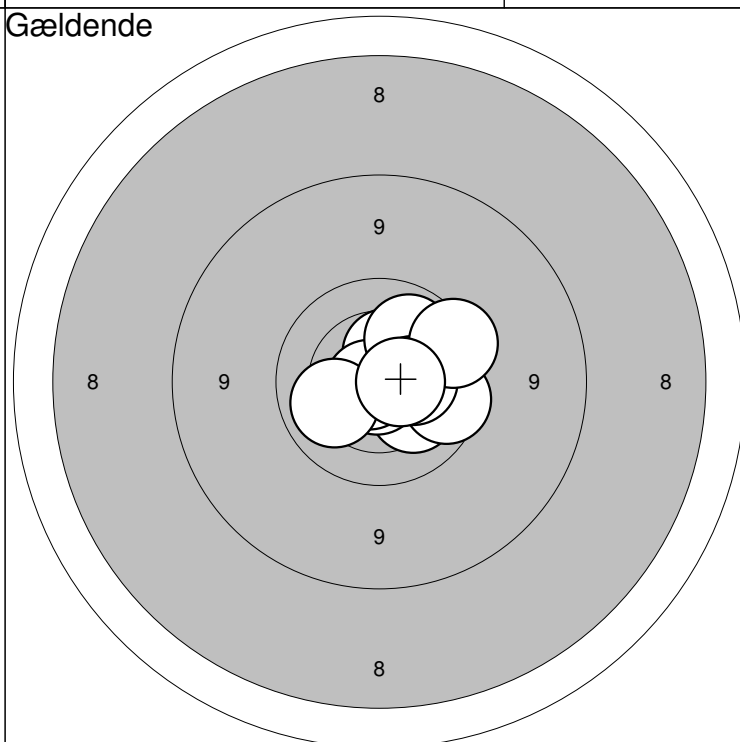

1: 10,6\* →

2: 10,5\* ↗

3: 10,3 ↘

4: 10,4 ↘

5: 10,1 ←

6: 10,6\* ↘

7: 10,0 →

8: 10,4 ↘

9: 10,3 ↗

10: 9,6 ↖

Serie: 99,0

Sum: 99,0

11: 10,2 ↘

12: 10,4 ↗

13: 10,8\* ↘

14: 10,8\* ←

15: 10,1 ↗

16: 9,8 →

17: 10,4 →

18: 9,7 ↗

19: 10,1 ←

20: 10,6\* →

Serie: 98,0

Sum: 197,0

Jyllandsstævne 2011



Hold

42

Bane

6

Rasmus M. Larsen

Vilsted Skf.

ÅK1

Jyllandsstævne 2011 - riffel

Aalborg Skyttekreds

Prøveskud

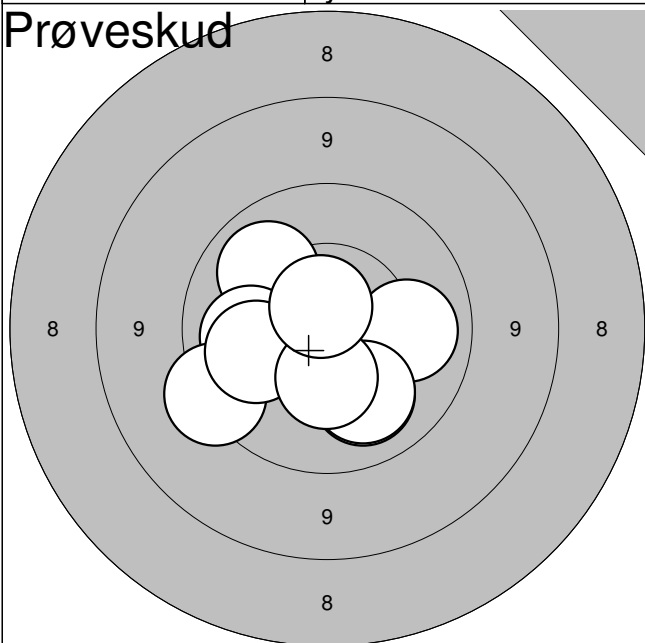

1: 10,1  
 2: 10,1  
 3: 9,5  
 4: 10,2  
 5: 10,2  
 6: 10,1  
 7: 10,2  
 8: 10,4  
 9: 10,7\*

↗  
 ←  
 ↙  
 ←  
 ↘  
 →  
 ↘  
 ↘  
 ↗

Serie: 89,0

Sum: 0,0

Gældende

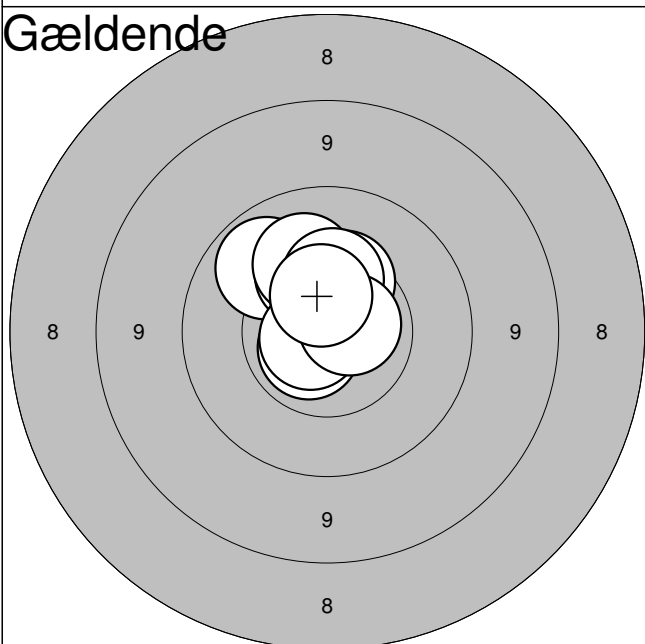

1: 10,7\*  
 2: 10,4  
 3: 10,0  
 4: 10,3  
 5: 10,4  
 6: 10,2  
 7: 10,8\*  
 8: 10,4  
 9: 10,7\*  
 10: 10,6

↙  
 ↗  
 ↗  
 ↗  
 ↗  
 ↗  
 ↙  
 ↗  
 →  
 ↗

Serie: 100,0

Sum: 100,0

Gældende

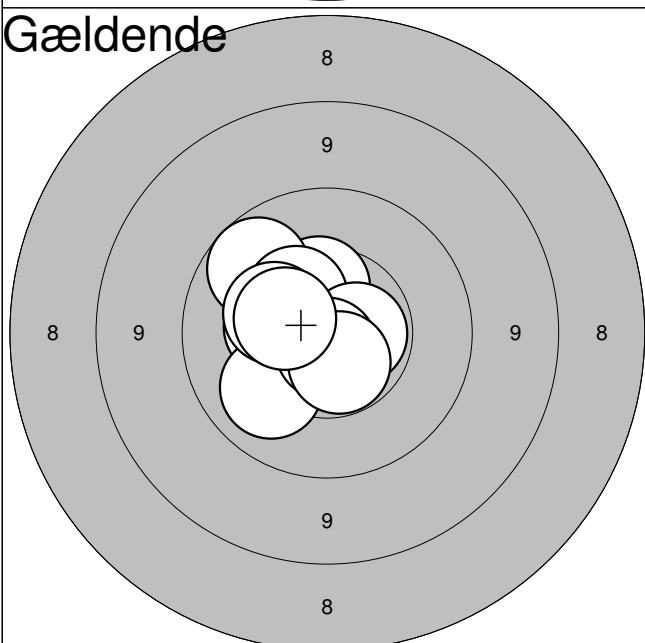

11: 10,5  
 12: 10,4  
 13: 10,0  
 14: 10,5  
 15: 10,6\*  
 16: 10,1  
 17: 10,8\*  
 18: 10,6\*  
 19: 10,4  
 20: 10,5

↗  
 ←  
 ↗  
 ↗  
 →  
 ↙  
 ↘  
 ↘  
 ↗  
 ↗

Serie: 100,0

Sum: 200,0

Jyllandsstævne 2011

Hold  
**42**Bane  
**7****Philip Kristensen**

Midtdjurs Skytteforening

BK1

Jyllandsstævne 2011 - riffel

Aalborg Skyttekreds

Prøveskud

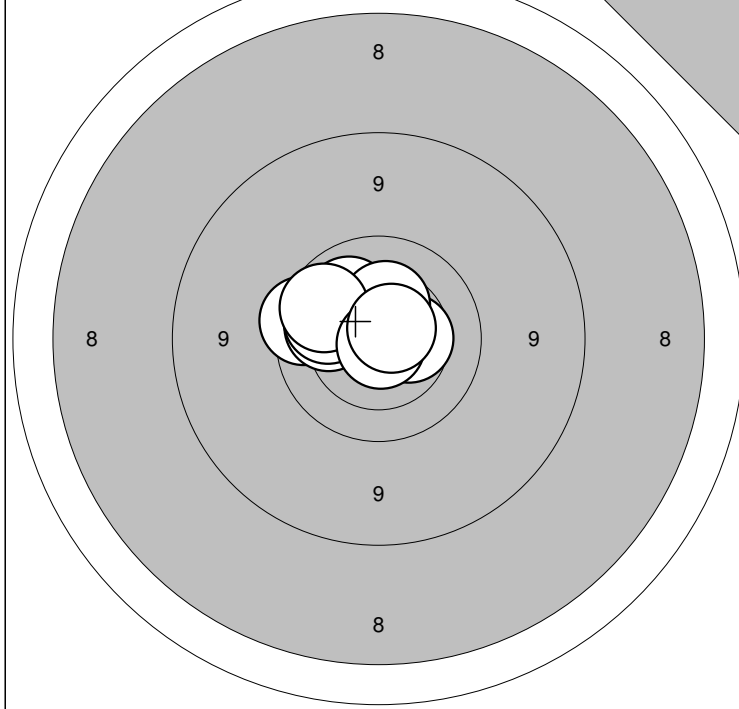

Prøveskud

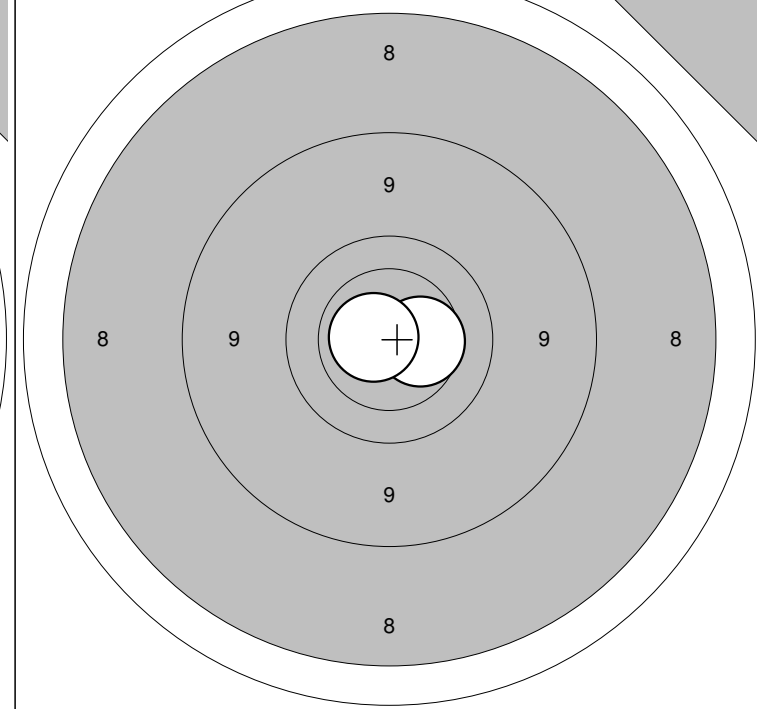
 1: 9,8 ←  
 2: 10,4 →  
 3: 10,2 ↗  
 4: 10,1 ↗  
 5: 10,1 ←

 6: 10,4 ↑  
 7: 10,0 ←  
 8: 9,9 ←  
 9: 10,8\* ↓  
 10: 10,7\* ↗

Serie: 98,0

Sum: 0,0

 11: 10,4 →  
 12: 10,7\* ←

Serie: 20,0

Sum: 0,0

Gældende

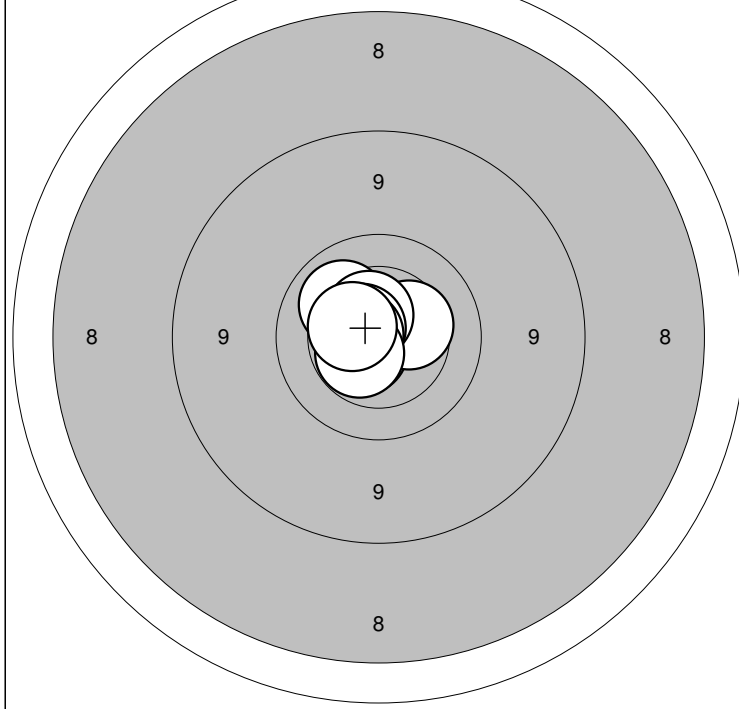

Gældende

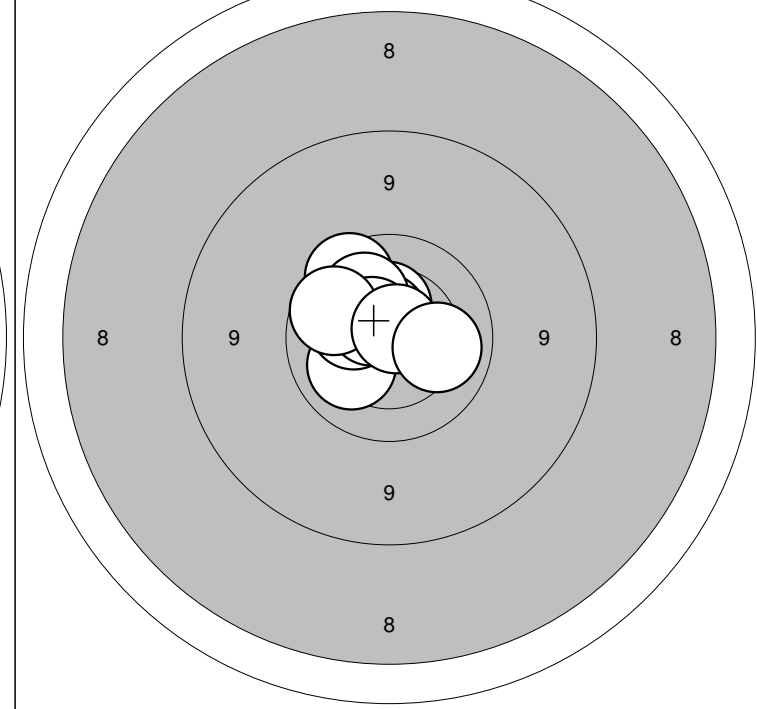
 1: 10,6\* ↙  
 2: 10,5\* ↗  
 3: 10,6\* ↗  
 4: 10,1 ↗  
 5: 10,4 →

 6: 10,5\* ↗  
 7: 10,6\* ←  
 8: 10,6\* ←  
 9: 10,5\* ↙  
 10: 10,5 ←

Serie: 100,0

Sum: 100,0

 11: 10,4 ↑  
 12: 9,8 ↗  
 13: 10,6\* ↑  
 14: 10,2 ↗  
 15: 10,2 ↙

 16: 10,3 ←  
 17: 10,6\* ↗  
 18: 9,9 ←  
 19: 10,8\* ↗  
 20: 10,1 →

Serie: 98,0

Sum: 198,0

Jyllandsstævne 2011

Hold  
**42**

Bane  
**8**

# Christian Pallisgaard

Mou & Omegns Skf.

BK3

Jyllandsstævne 2011 - riffel

Aalborg Skyttekreds

Prøveskud

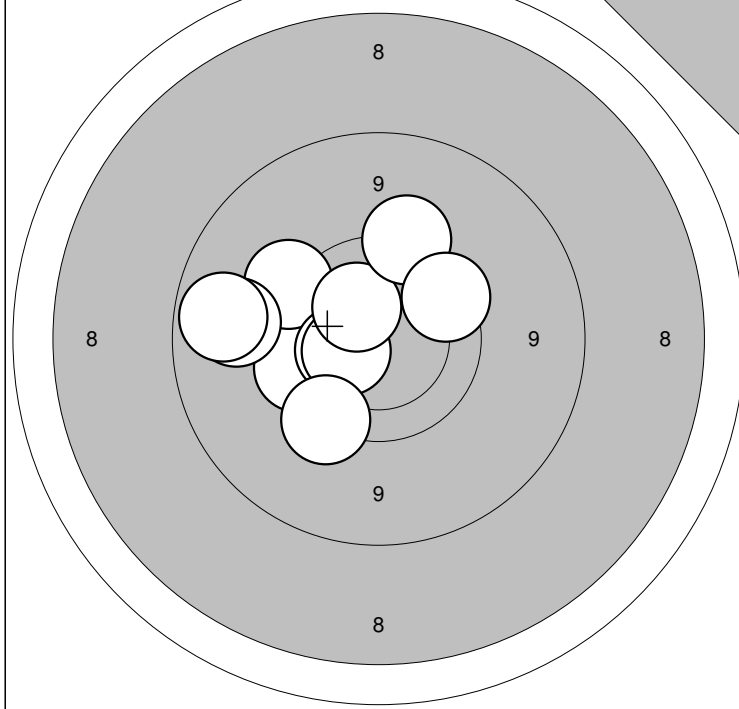

Prøveskud

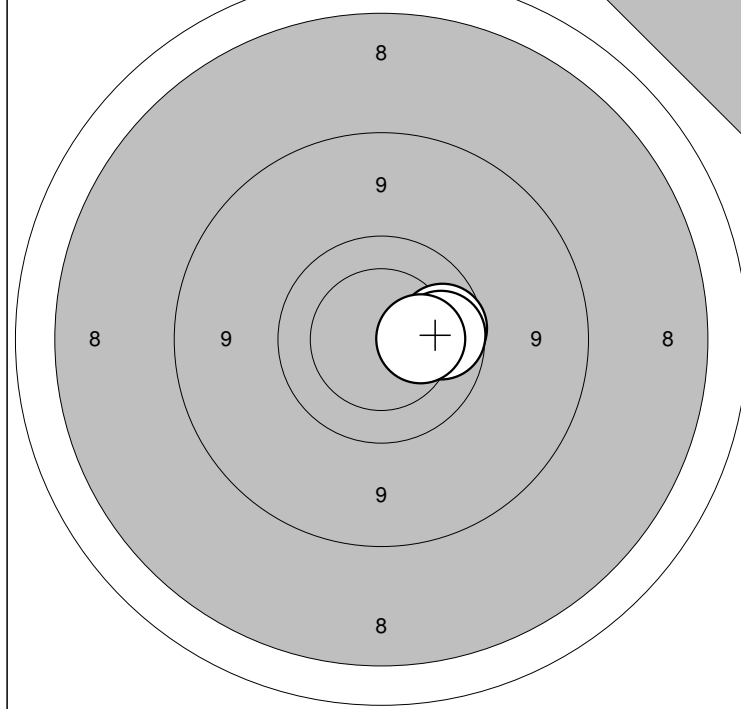

1: 9,7	←	6: 9,0	←
2: 9,5	↖	7: 10,3	↗
3: 10,3	←	8: 9,5	↑
4: 9,1	←	9: 9,6	↘
5: 10,4	←	10: 9,8	↗

Serie:	93,0
Sum:	0,0

11: 9,9	→
12: 9,9	→
13: 10,3	→

Serie:	28,0
Sum:	0,0

Gældende

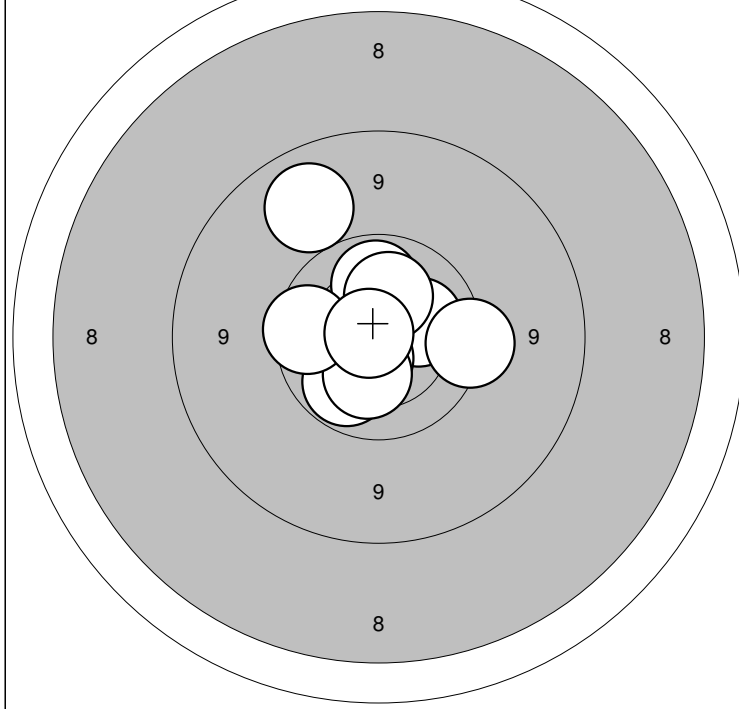

Gældende

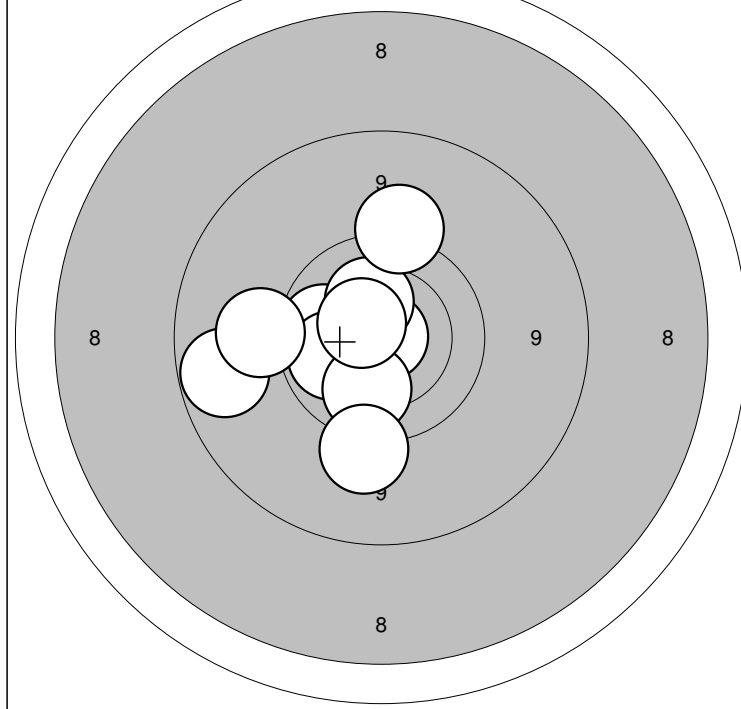

1: 10,2	→	6: 9,6	→
2: 10,6*	↘	7: 10,3	↘
3: 10,1	↑	8: 9,8	←
4: 10,0	↘	9: 10,2	↑
5: 9,1	↖	10: 10,8*	←

Serie:	97,0
Sum:	97,0

11: 10,9*	↗	16: 9,4	↘
12: 10,0	←	17: 10,3	↖
13: 10,1	←	18: 9,4	←
14: 10,0	↘	19: 9,5	↑
15: 9,0	←	20: 10,5*	↖

Serie:	96,0
Sum:	193,0

## Prøveskud

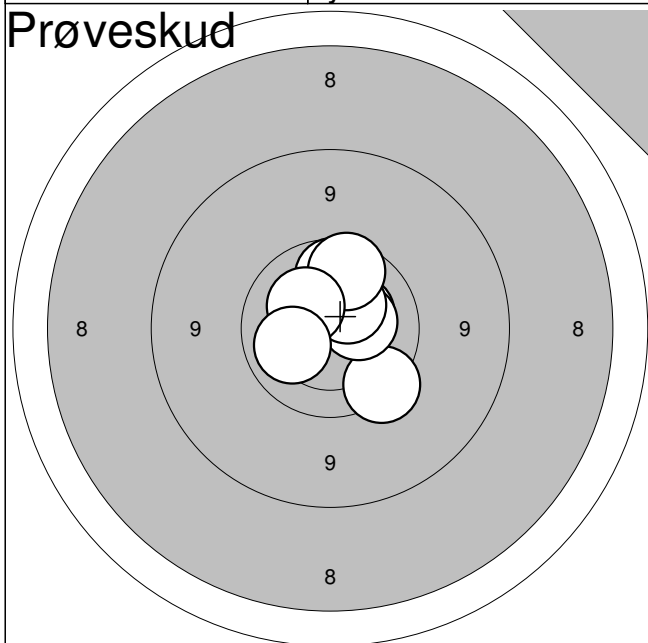

1:	9,9	↑
2:	9,7	↘
3:	10,4	↗
4:	10,4	→
5:	10,4	↗
6:	9,9	↑
7:	10,3	↗
8:	10,1	↙

Serie: 77,0

Sum: 0,0

## Gældende

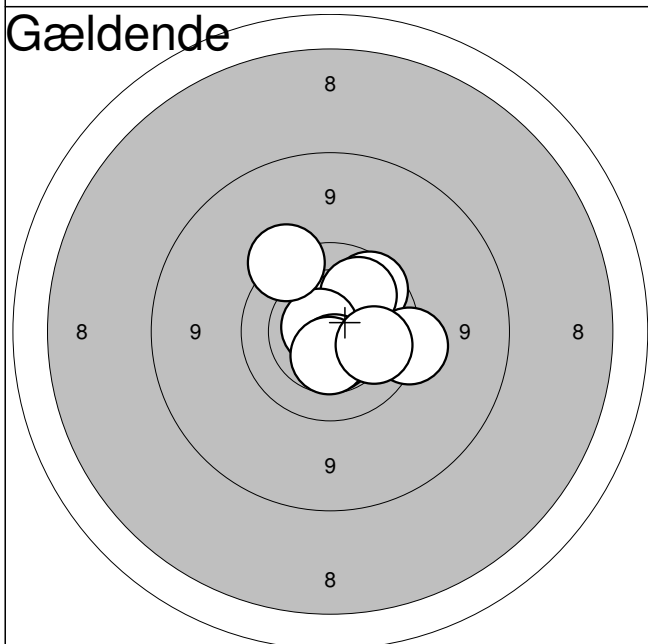

1:	10,9*	↑
2:	10,6*	↑
3:	9,9	↗
4:	10,1	↗
5:	10,7*	↙
6:	10,5*	↘
7:	9,6	↗
8:	10,5	↘
9:	9,6	→
10:	10,0	→

Serie: 97,0

Sum: 97,0

## Gældende

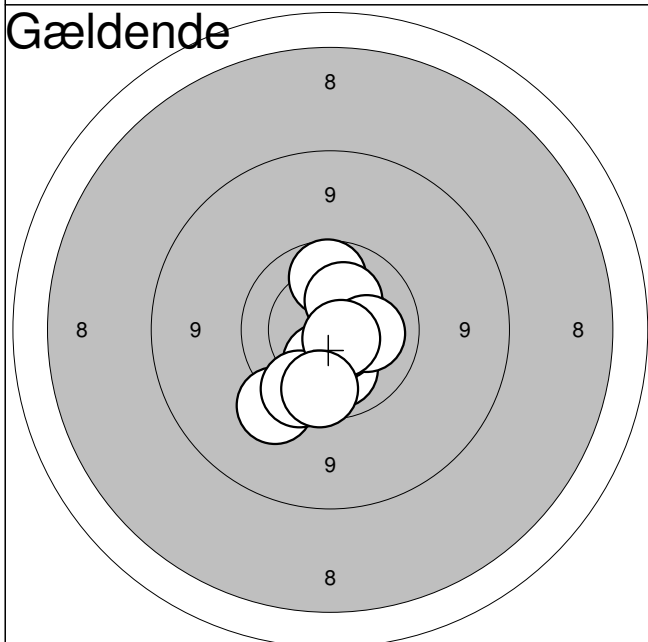

11:	9,9	↑
12:	10,1	↘
13:	10,6*	↘
14:	9,5	↘
15:	10,3	↘
16:	10,3	↗
17:	10,2	→
18:	9,8	↘
19:	10,7*	↘
20:	9,9	↘

Serie: 96,0

Sum: 193,0

Hold  
**42**

Bane  
**10**

# Anna Sloth Borregaard

Mou & Omegns Skf.

BK3

Jyllandsstævne 2011 - riffel

Aalborg Skyttekreds

Prøveskud

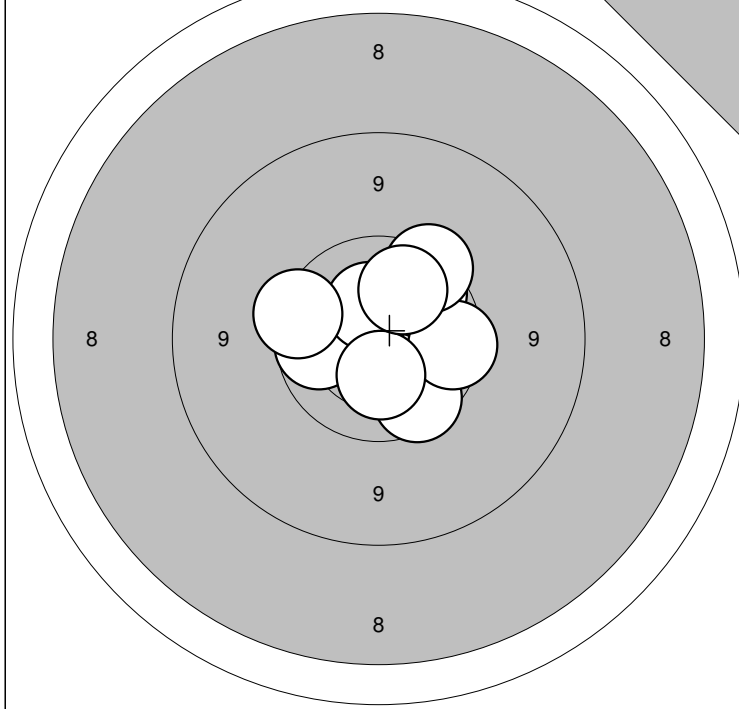

Prøveskud

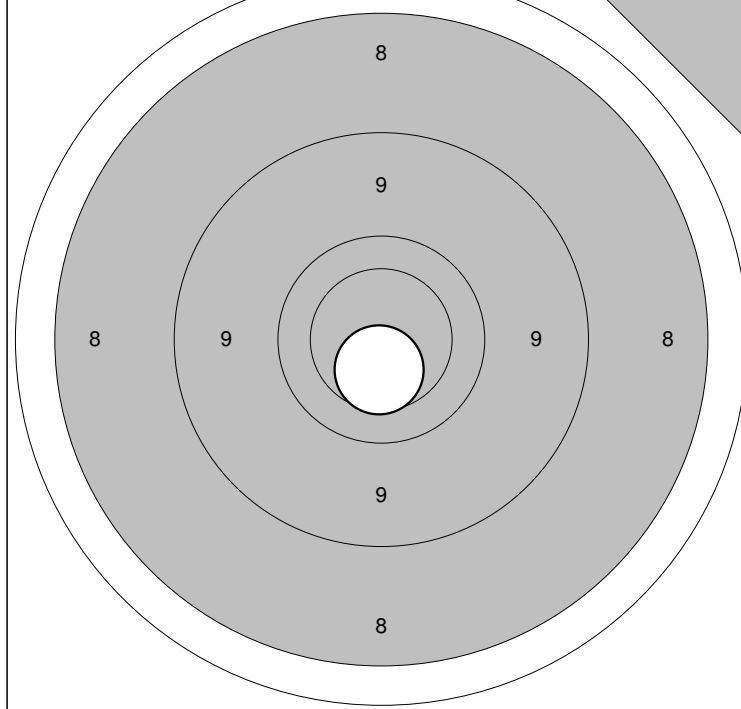

1:10,4	↘	6: 9,8	→
2: 9,9	↗	7:10,3	↓
3: 9,9	←	8: 9,7	↗
4:10,4	↑	9:10,0	↗
5: 9,8	↘	10: 9,7	←

Serie:	94,0
Sum:	0,0

11:10,4	↓
---------	---

Serie:	10,0
Sum:	0,0

Gældende

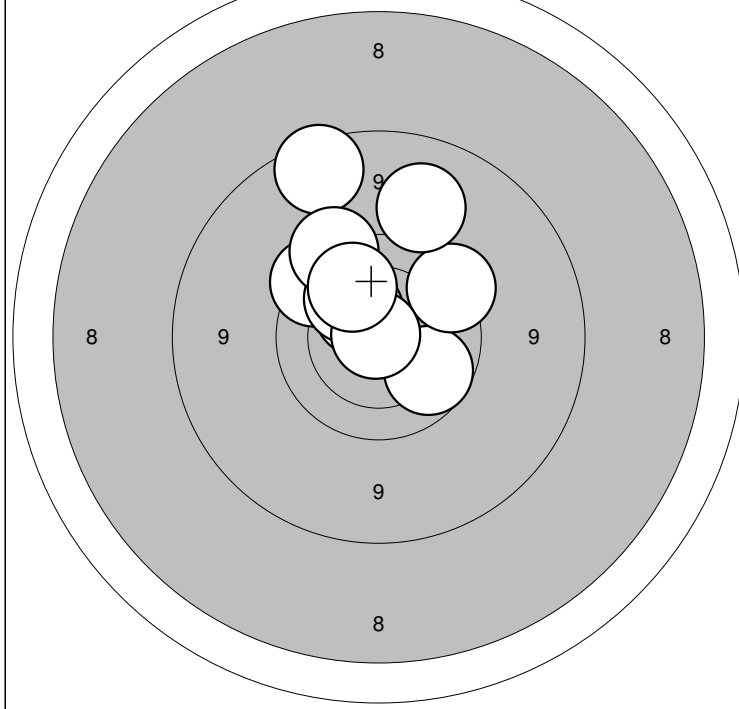

Gældende

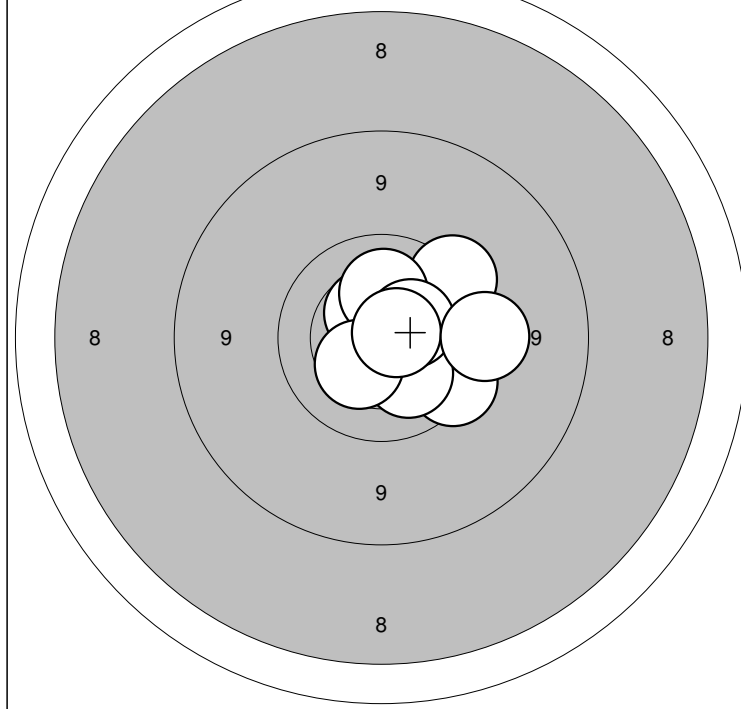

1: 8,9	↗	6:10,1	↗
2: 9,9	↘	7:10,9*	↗
3: 9,7	↗	8: 9,6	↗
4: 9,7	↗	9: 9,2	↑
5:10,4	↗	10:10,0	↗

Serie:	93,0
Sum:	93,0

11:10,7*	↑	16:10,2	↑
12: 9,7	↘	17:10,4	↗
13: 9,6	↗	18:10,4	↘
14:10,5	↗	19:10,7*	↗
15:10,2	↘	20: 9,5	→

Serie:	97,0
Sum:	190,0

Hold

42

Bane

11

Emili H. Sørensen

Mou &amp; Omegns Skf.

BK3

Jyllandsstævne 2011 - riffel

Aalborg Skyttekreds

Prøveskud

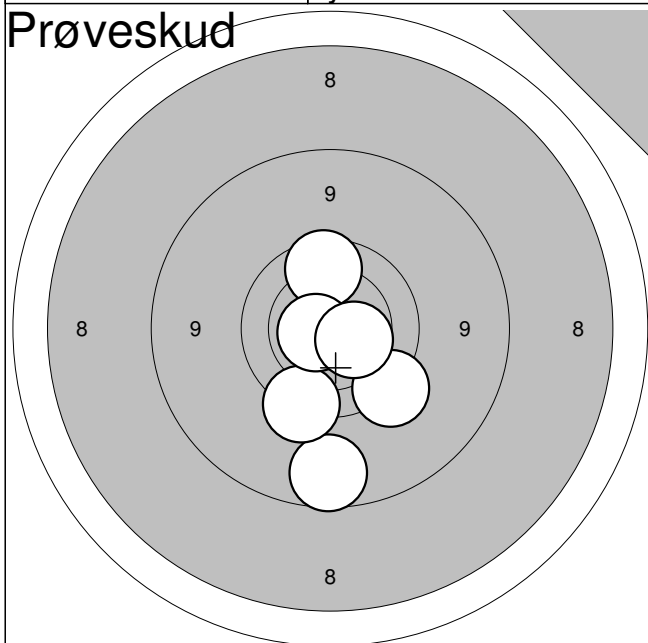

1: 9,9  
 2: 8,9  
 3: 9,6  
 4: 9,6  
 5: 10,7\*  
 6: 10,4

↑  
 ↓  
 ↘  
 ↓  
 ←  
 →

Serie: 55,0

Sum: 0,0

Gældende

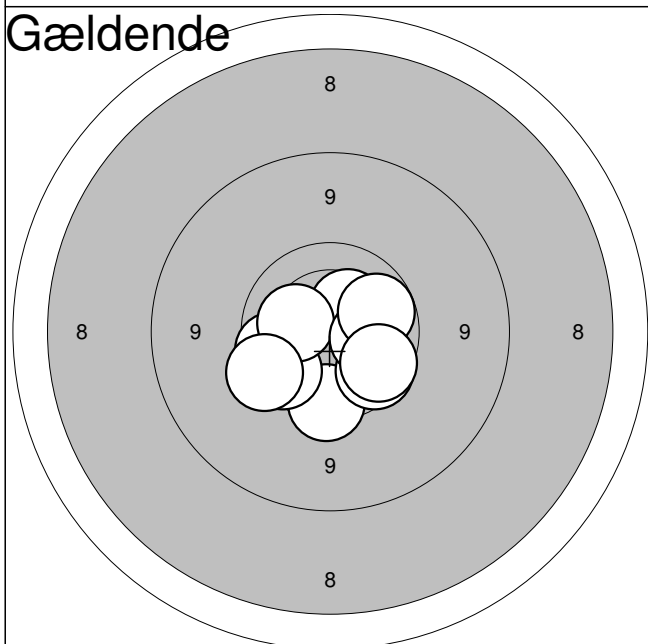

1: 9,7  
 2: 9,9  
 3: 9,9  
 4: 10,4  
 5: 9,8  
 6: 10,3  
 7: 9,7  
 8: 10,2  
 9: 10,0  
 10: 9,9

↓  
 ↘  
 ←  
 ↗  
 ↘  
 ←  
 ↘  
 →  
 →  
 ↘

Serie: 94,0

Sum: 94,0

Gældende

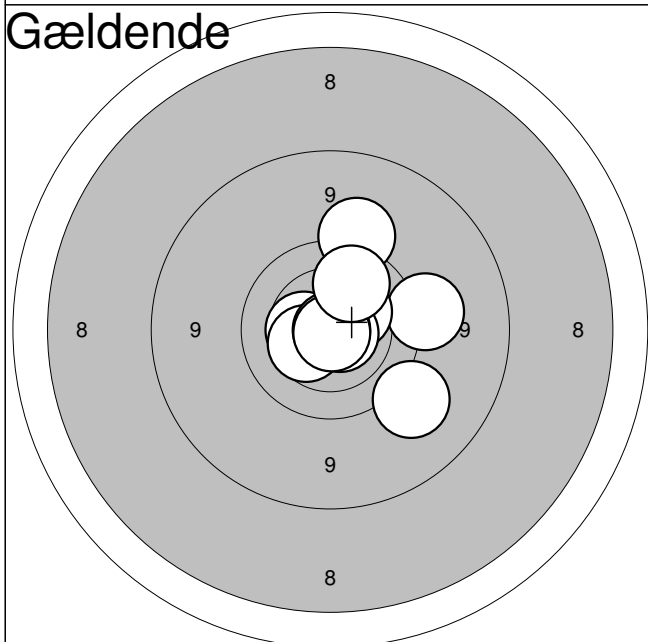

11: 9,3  
 12: 9,4  
 13: 10,4  
 14: 9,4  
 15: 10,4  
 16: 10,7\*  
 17: 10,4  
 18: 10,9\*  
 19: 10,9\*  
 20: 10,0

↘  
 ↑  
 ←  
 →  
 ↗  
 →  
 ↘  
 ↘  
 ↘  
 ↗

Serie: 97,0

Sum: 191,0

Jyllandsstævne 2011

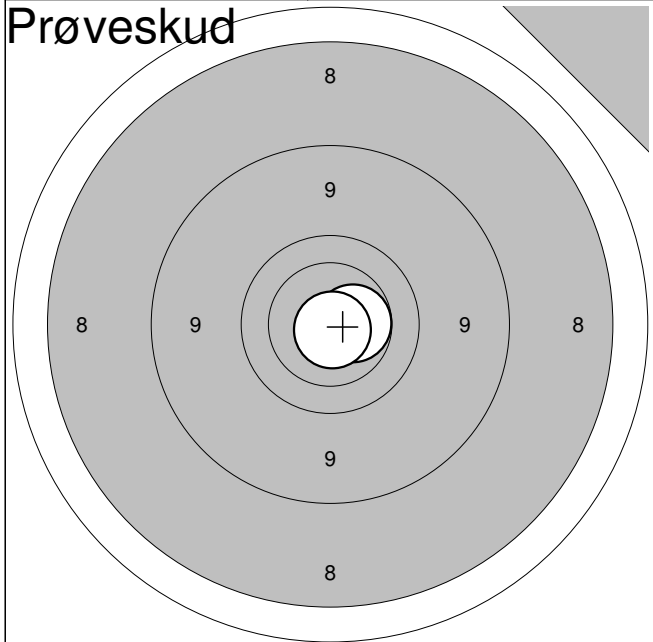

1:	10,5*	→
2:	10,8*	↓
<b>Serie:</b>		<b>20,0</b>
<b>Sum:</b>		<b>0,0</b>

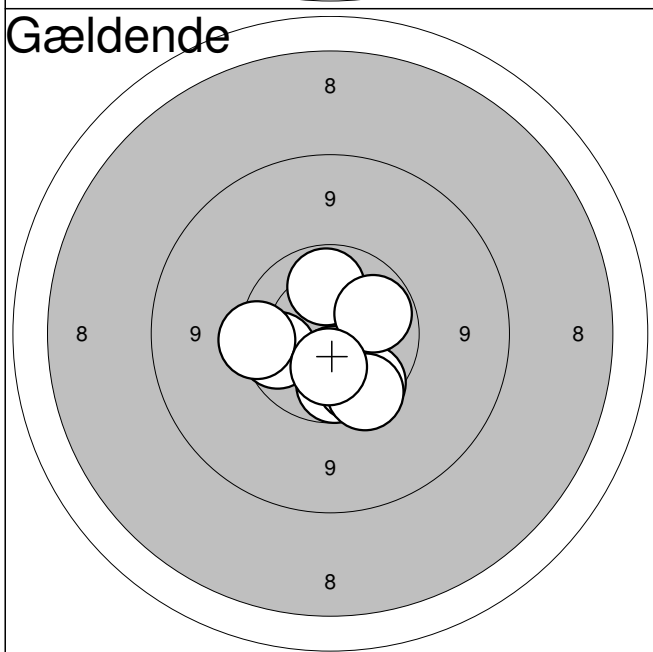

1:	9,9	↓
2:	10,3	↓
3:	9,9	↓
4:	9,9	←
5:	10,0	↑
6:	9,8	↓
7:	9,8	↓
8:	10,0	→
9:	9,7	←
10:	10,3	↓
<b>Serie:</b>		<b>94,0</b>
<b>Sum:</b>		<b>94,0</b>

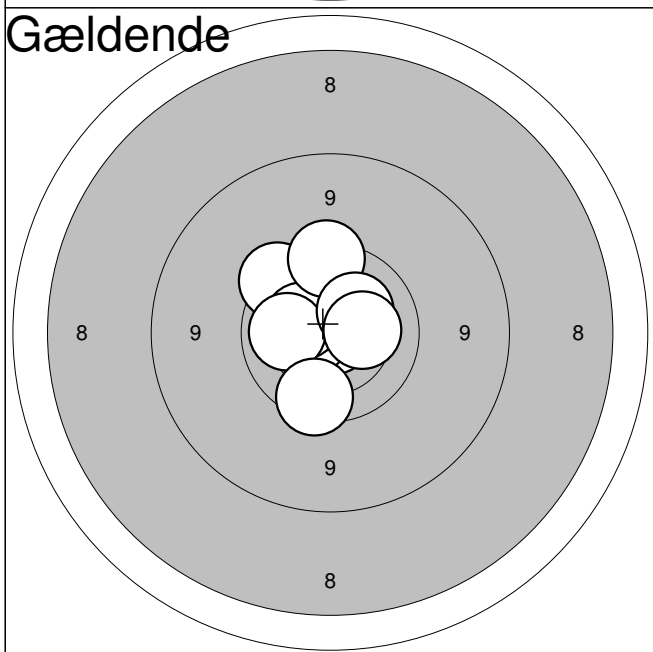

11:	10,5	→
12:	10,9*	↓
13:	10,5*	←
14:	9,7	↗
15:	10,4	↖
16:	10,1	←
17:	9,7	↑
18:	10,3	↗
19:	9,8	↓
20:	10,3	→
<b>Serie:</b>		<b>97,0</b>
<b>Sum:</b>		<b>191,0</b>

Hold  
**43**Bane  
**1****Jørn Kristensen**

Midtdjurs Skytteforening

ÅK2

Jyllandsstævne 2011 - riffel

Aalborg Skyttekreds

Prøveskud

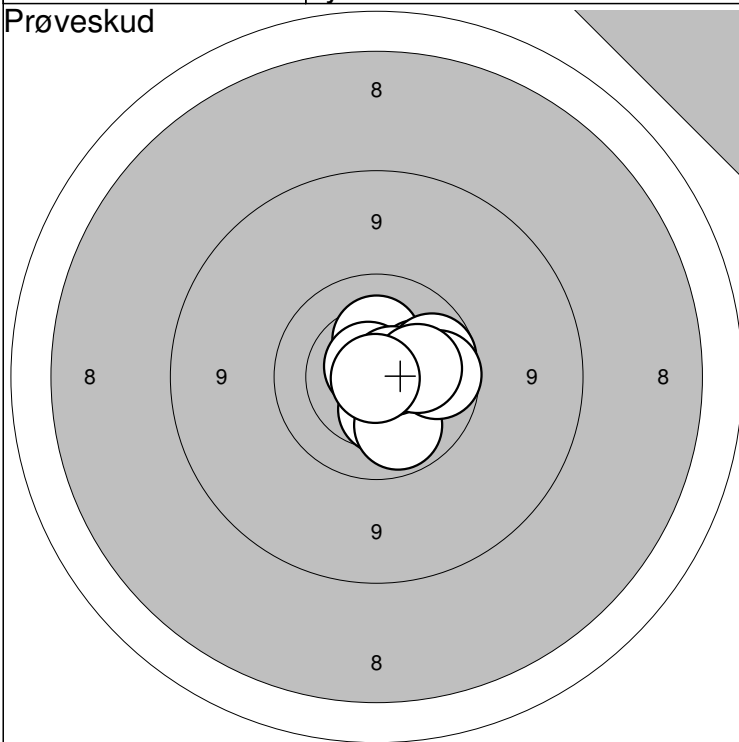

Prøveskud

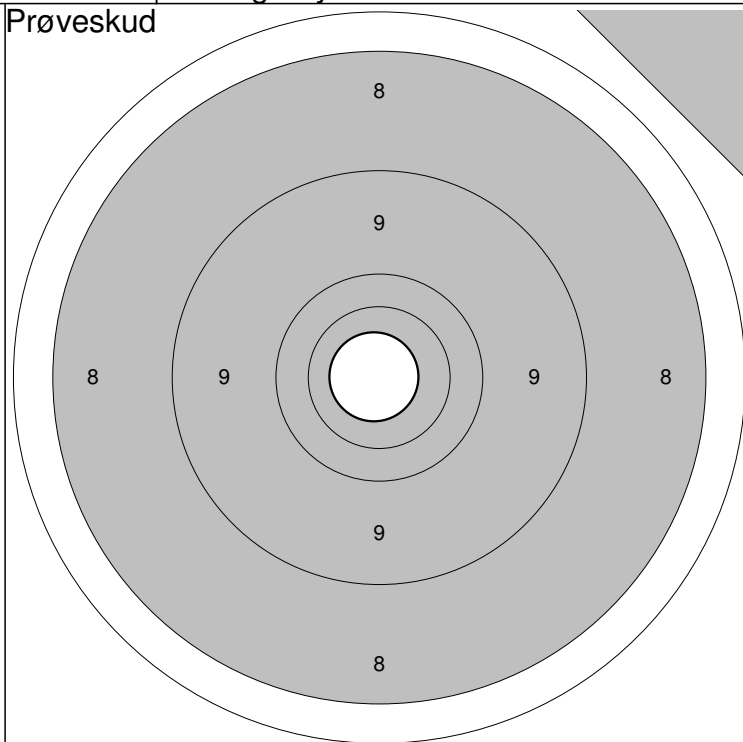

1:10,3

↑

6: 9,9

→

2:10,4

↓

7:10,7\*

→

Serie: 98,0

11:10,9\*

←

Serie: 10,0

3:10,7\*

↗

8: 9,9

→

4:10,2

→

9:10,2

→

Sum: 0,0

5:10,0

↓

10:10,9\*

↙

Sum: 0,0

Gældende

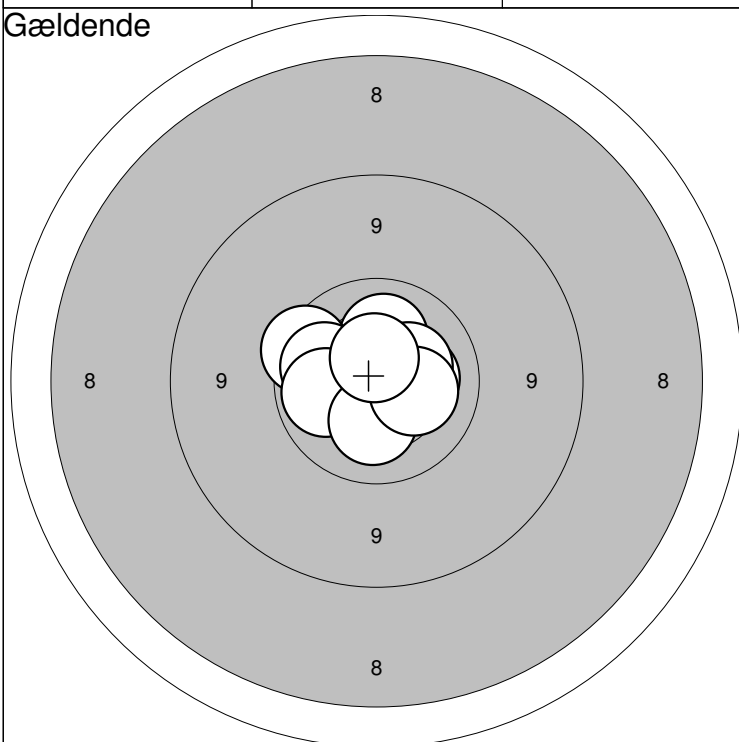

Gældende

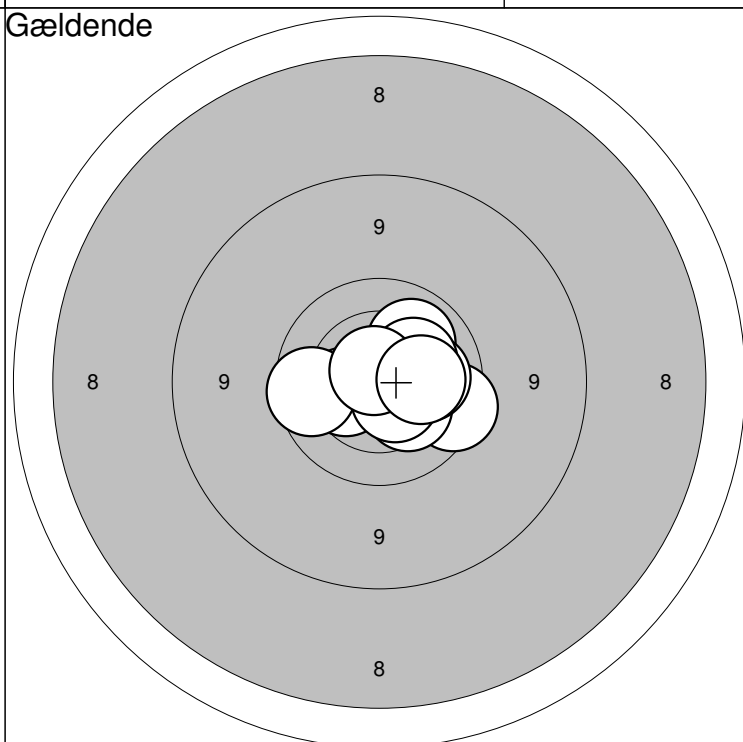

1:10,5

←

6:10,0

←

Serie: 99,0

11:10,1

↗

16:10,6\*

↘

Serie: 98,0

2:10,2

↑

7:10,1

←

12: 9,8

→

17:10,3

↗

3:10,3

→

8:10,3

↓

Sum: 99,0

13:10,3

↘

18: 9,9

←

Sum: 197,0

4: 9,8

↖

9:10,3

→

14:10,4

←

19:10,7\*

↗

5:10,4

→

10:10,6\*

↑

15:10,1

→

20:10,2

→

Jyllandsstævne 2011



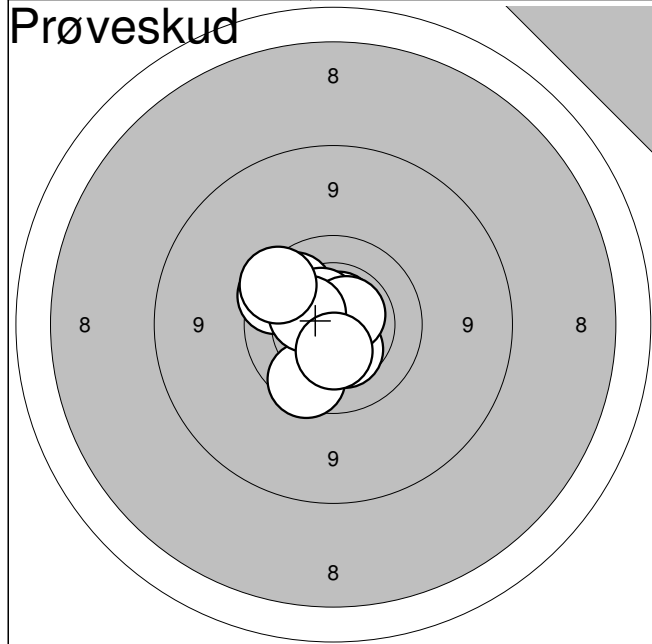

1:	9,8	↖
2:	10,7*	↗
3:	10,4	↘
4:	9,8	↘
5:	9,9	↗
6:	10,5*	↗
7:	10,6*	↗
8:	10,4	↖
9:	9,8	↗
10:	10,4	↘

**Serie: 96,0**

**Sum: 0,0**

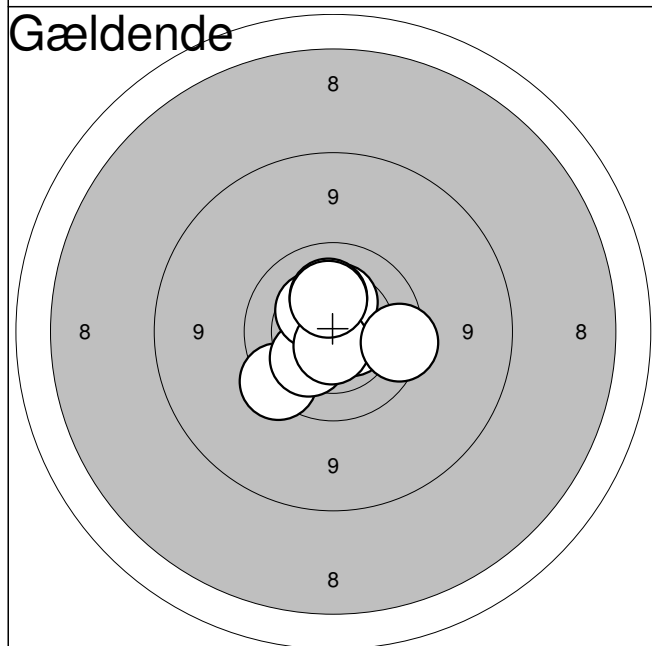

1:	9,7	↘
2:	10,2	↘
3:	10,6*	→
4:	10,4	↑
5:	10,4	↗
6:	10,4	↗
7:	10,7*	↘
8:	10,3	↑
9:	9,8	→
10:	10,3	↑

**Serie: 98,0**

**Sum: 98,0**

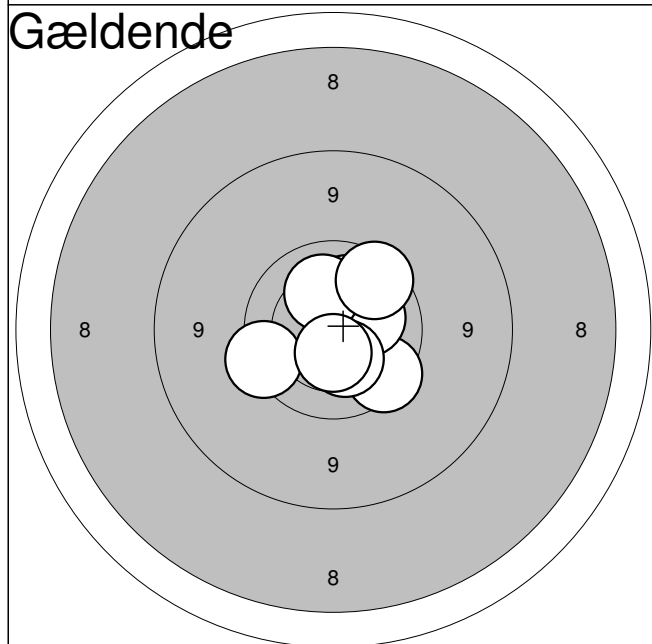

11:	10,6*	↗
12:	10,2	↗
13:	9,7	↖
14:	9,8	↘
15:	10,4	↗
16:	10,2	→
17:	10,3	↘
18:	10,2	↑
19:	9,8	↗
20:	10,5*	↘

**Serie: 97,0**

**Sum: 195,0**

Hold

43

Bane

3

## Louise Bedsted

Vester Han Herred Skytteforeni

2

Jyllandsstævne 2011 - riffel

Aalborg Skyttekreds

## Prøveskud

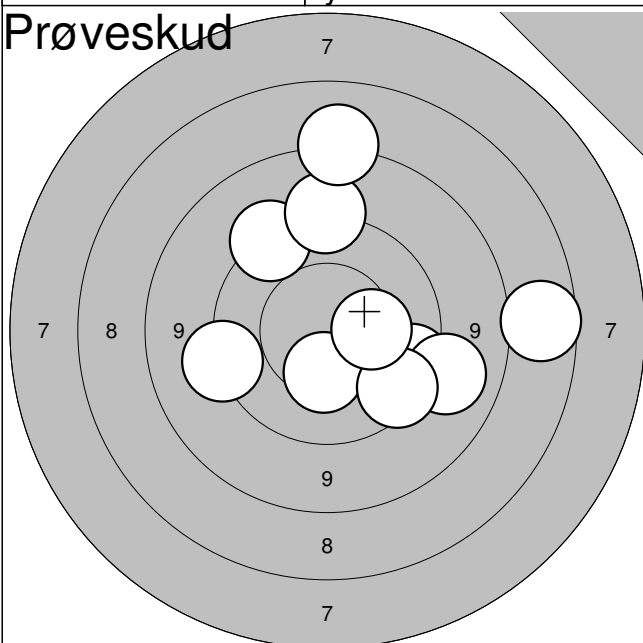

1:	9,7	↘
2:	7,9	→
3:	10,4	↓
4:	9,2	↘
5:	9,5	↗
6:	9,7	↘
7:	9,3	↑
8:	10,3	→
9:	9,4	←
10:	8,3	↑

Serie: 89,0

Sum: 0,0

## Gældende

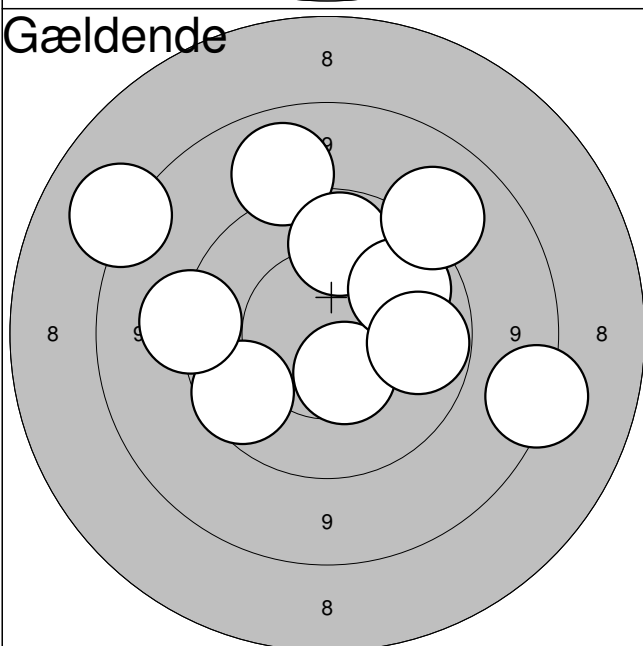

1:	9,1	↑
2:	9,8	↙
3:	10,5	↓
4:	8,5	→
5:	10,0	↑
6:	10,1	↗
7:	9,5	←
8:	8,3	↗
9:	10,0	→
10:	9,2	↗

Serie: 92,0

Sum: 92,0

## Gældende

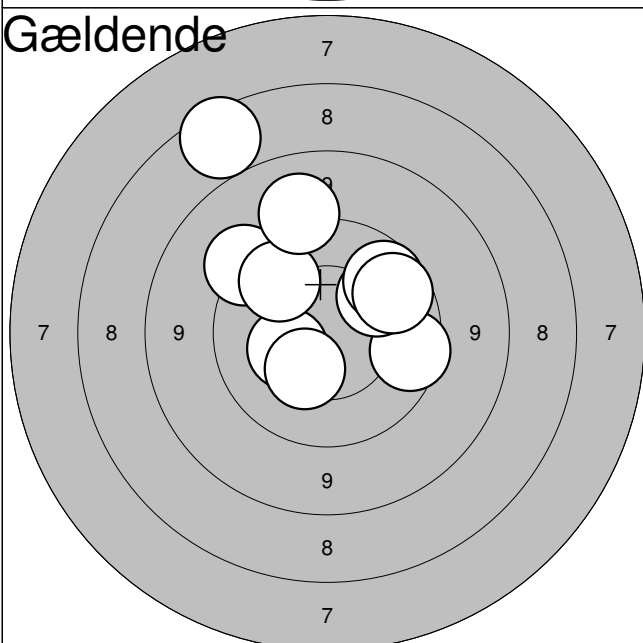

11:	9,5	↗
12:	10,4	↙
13:	10,0	↗
14:	9,8	→
15:	10,1	↗
16:	10,4	↘
17:	9,9	↗
18:	7,8	↗
19:	9,2	↑
20:	9,9	↗

Serie: 92,0

Sum: 184,0

Jyllandsstævne 2011

Hold

43

Bane

4

## Ann-Berit Bedsted

Vester Han Herred Skytteforeni

ÅK2

Jyllandsstævne 2011 - riffel

Aalborg Skyttekreds

## Prøveskud

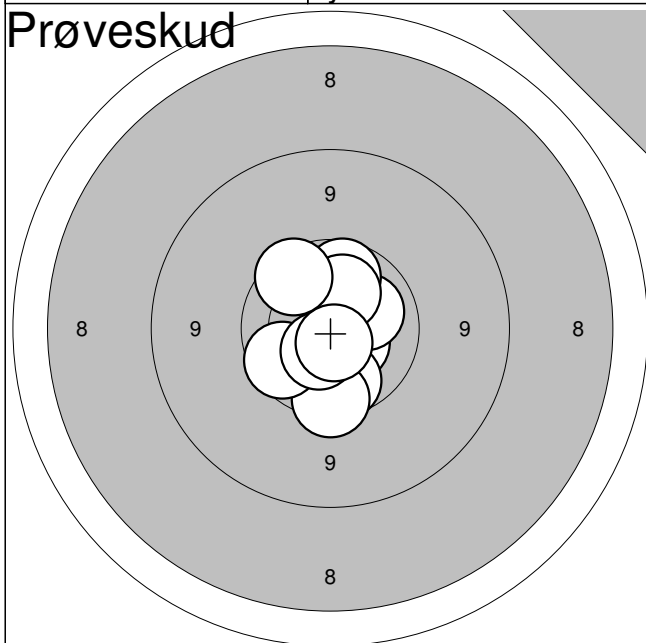

1:	10,4	↘
2:	9,9	↓
3:	9,7	↓
4:	10,2	→
5:	9,9	↑
6:	9,9	←
7:	10,2	↑
8:	10,5	↓
9:	10,6*	↓
10:	9,8	↑

Serie: 95,0

Sum: 0,0

## Gældende

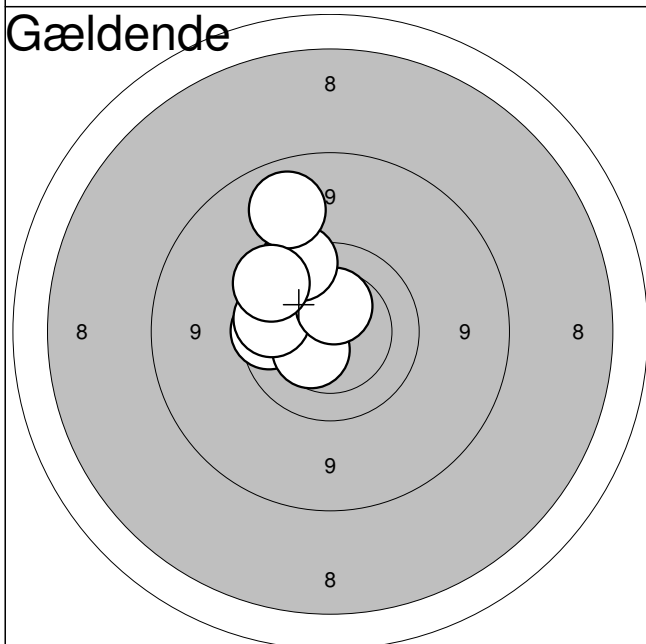

1:	9,8	←
2:	10,5*	←
3:	10,5*	←
4:	10,4	↑
5:	10,4	↓
6:	9,9	←
7:	10,4	↑
8:	9,7	↑
9:	9,1	↑
10:	9,7	↗

Serie: 95,0

Sum: 95,0

## Gældende

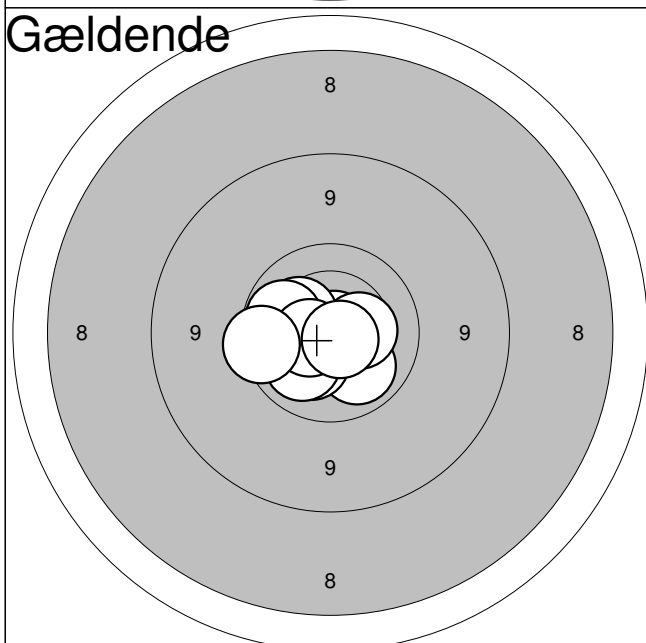

11:	10,8*	↗
12:	10,3	↗
13:	10,1	↓
14:	10,0	←
15:	10,3	↓
16:	10,1	↓
17:	10,5*	←
18:	10,4	→
19:	9,7	←
20:	10,7*	↓

Serie: 99,0

Sum: 194,0

Jyllandsstævne 2011

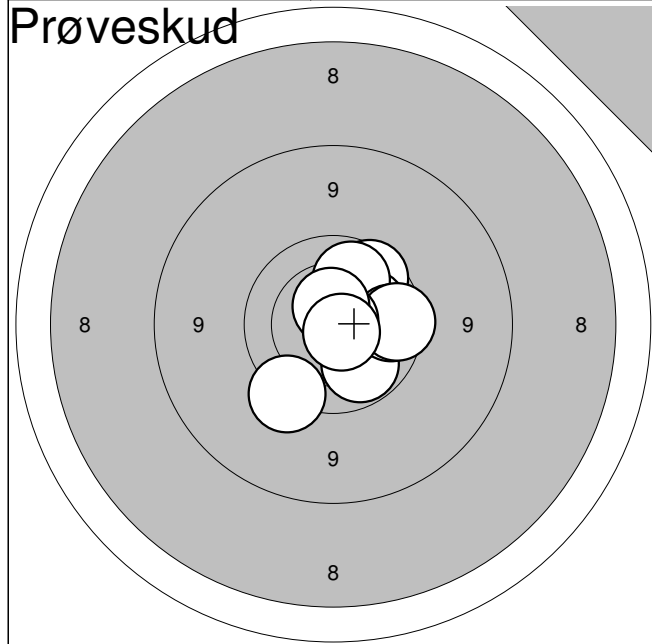

1:	9,9	↗
2:	10,0	↘
3:	10,2	→
4:	10,0	↑
5:	9,9	→
6:	9,8	→
7:	10,8*	↗
8:	9,6	↘
9:	10,6*	↑
10:	10,7*	↘

**Serie: 96,0**

**Sum: 0,0**

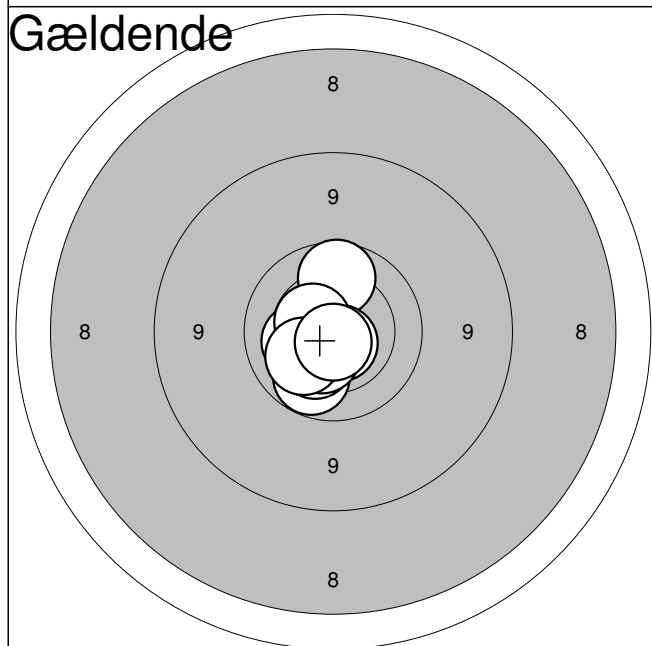

1:	10,0	↘
2:	9,9	↑
3:	10,6*	←
4:	10,7*	↘
5:	10,3	←
6:	10,3	↘
7:	10,5*	↖
8:	10,4	↘
9:	10,2	↖
10:	10,7*	↓

**Serie: 99,0**

**Sum: 99,0**

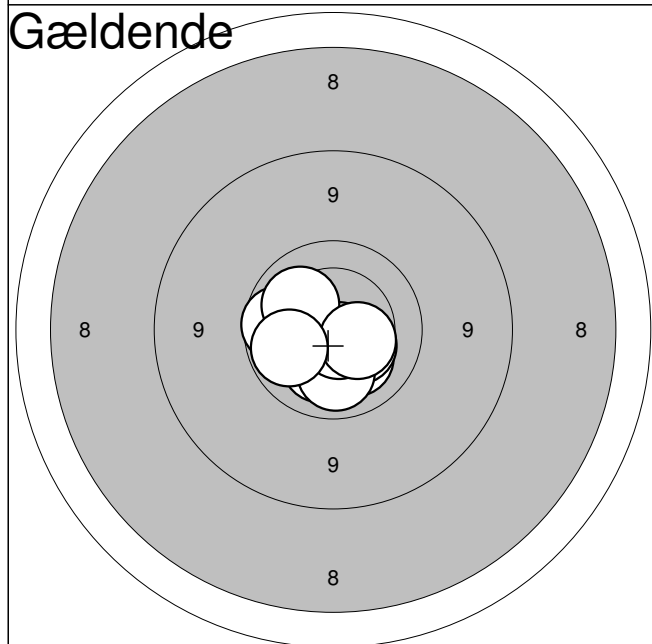

11:	10,3	↓
12:	10,2	↘
13:	10,2	↘
14:	10,4	↘
15:	9,9	←
16:	10,1	↘
17:	10,7*	↘
18:	10,2	↗
19:	10,4	→
20:	10,0	←

**Serie: 99,0**

**Sum: 198,0**

Hold  
**43**Bane  
**6****Lisette Andersen**

Mou &amp; Omegns Skf.

BK3

Jyllandsstævne 2011 - riffel

Aalborg Skyttekreds

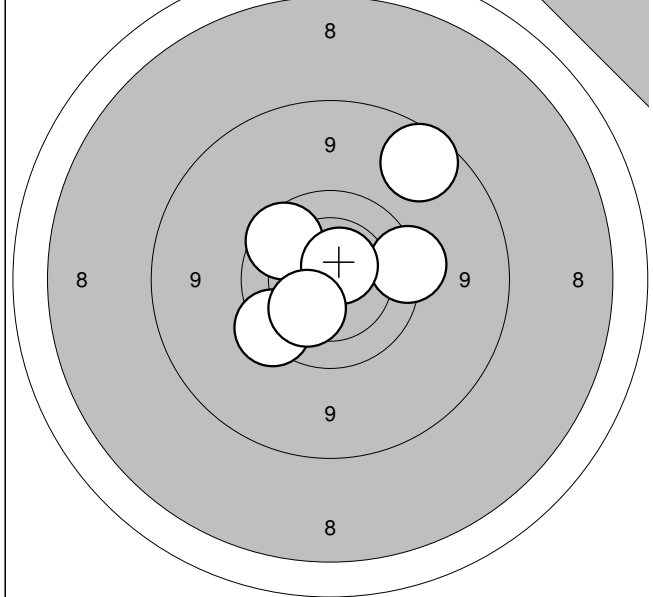
**Prøveskud**

1:	9,6	→
2:	8,9	↗
3:	9,9	↗
4:	9,7	↘
5:	10,6*	↗
6:	10,2	↘

Serie: 55,0

Sum: 0,0

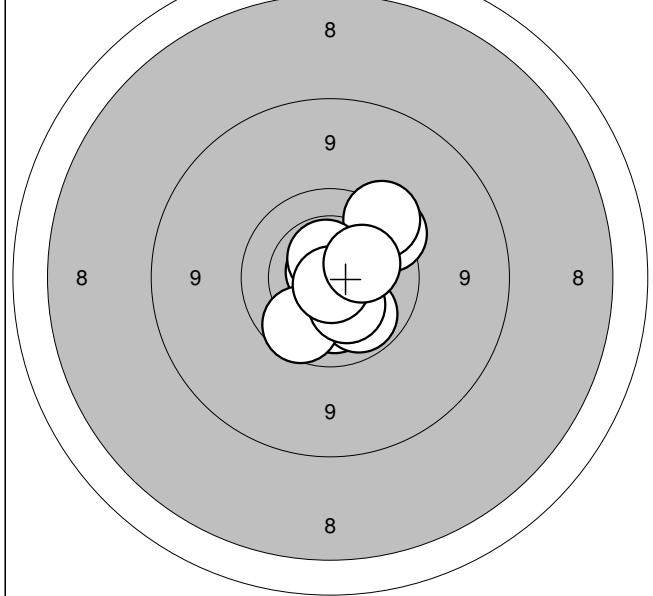
**Gældende**

1:	10,2	↓
2:	10,8*	↗
3:	10,0	↘
4:	9,9	↘
5:	9,7	↗
6:	9,7	↗
7:	10,3	↓
8:	10,6*	↑
9:	10,8*	↓
10:	10,3	→

Serie: 97,0

Sum: 97,0

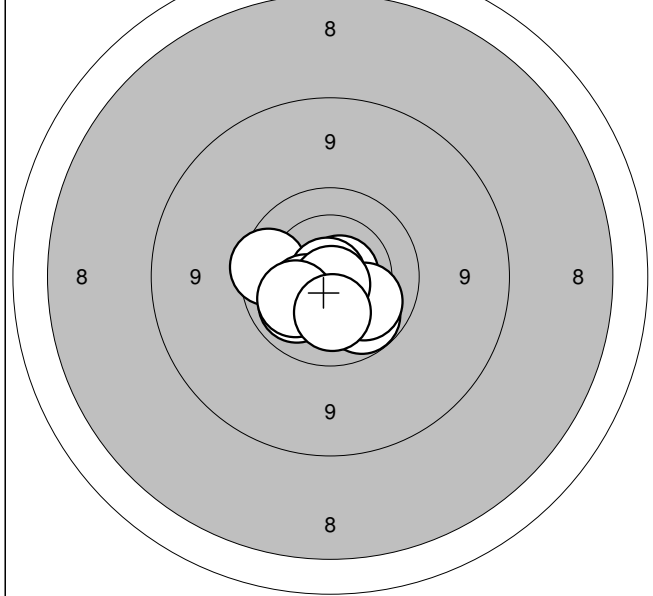
**Gældende**

11:	10,1	↘
12:	9,8	←
13:	10,7*	→
14:	10,0	↘
15:	10,9*	←
16:	10,4	↘
17:	10,1	↘
18:	10,8*	↓
19:	10,2	↘
20:	10,2	↓

Serie: 99,0

Sum: 196,0

Jyllandsstævne 2011

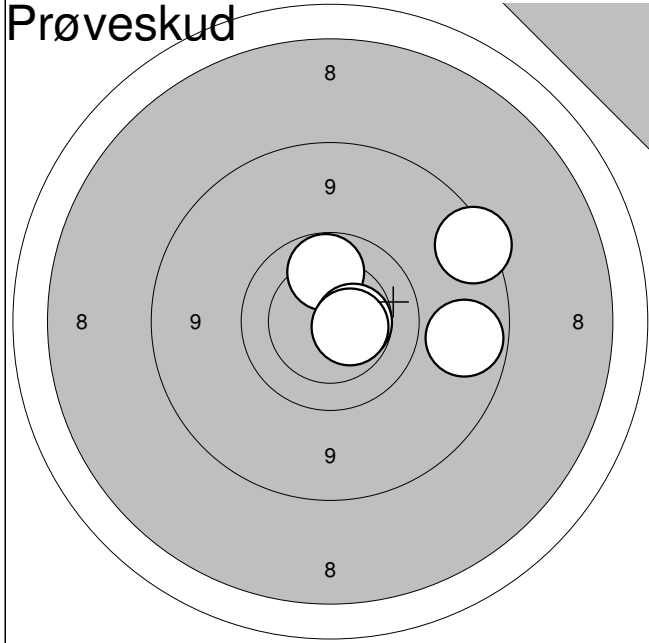

1:	10,0	↑
2:	9,0	→
3:	8,8	↗
4:	10,5	→
5:	10,5*	↘

<b>Serie:</b>	<b>47,0</b>
<b>Sum:</b>	<b>0,0</b>

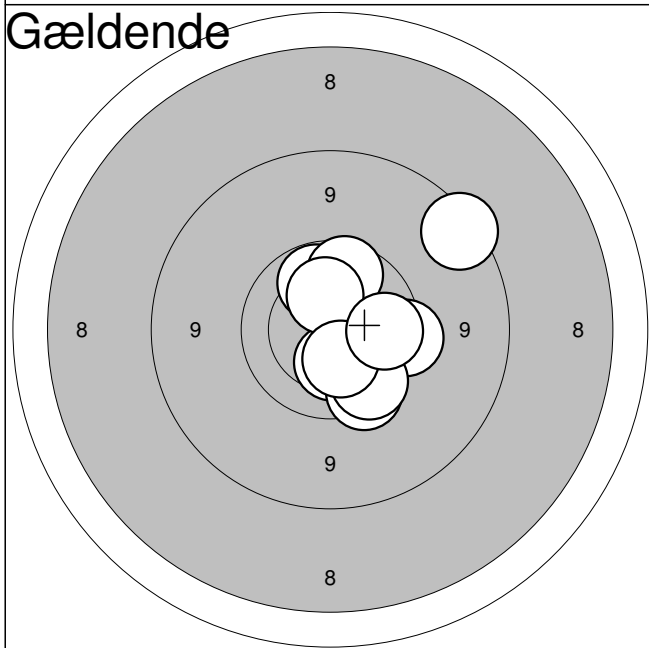

1:	9,7	→
2:	10,3	↓
3:	9,7	↓
4:	9,8	↓
5:	10,0	↑
6:	8,8	↗
7:	9,9	↑
8:	10,3	↑
9:	10,3	↓
10:	9,9	→

<b>Serie:</b>	<b>93,0</b>
<b>Sum:</b>	<b>93,0</b>

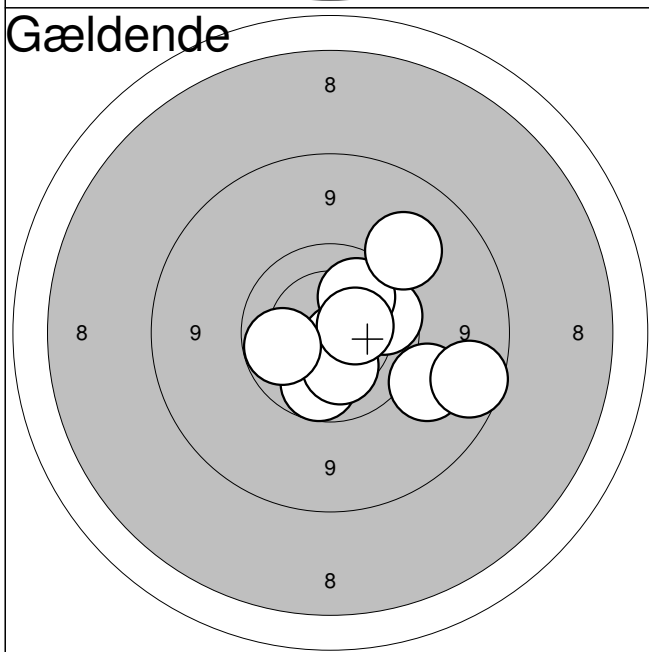

11:	9,9	↓
12:	10,7*	↓
13:	10,3	↓
14:	9,3	↘
15:	9,9	→
16:	10,1	↗
17:	9,3	↗
18:	8,9	→
19:	10,4	→
20:	10,0	←

<b>Serie:</b>	<b>94,0</b>
<b>Sum:</b>	<b>187,0</b>

Hold

43

Bane

8

## Annemette Mejlvang Guldbæk

Mou &amp; Omegns Skf.

BK4

Jyllandsstævne 2011 - riffel

Aalborg Skyttekreds

## Prøveskud

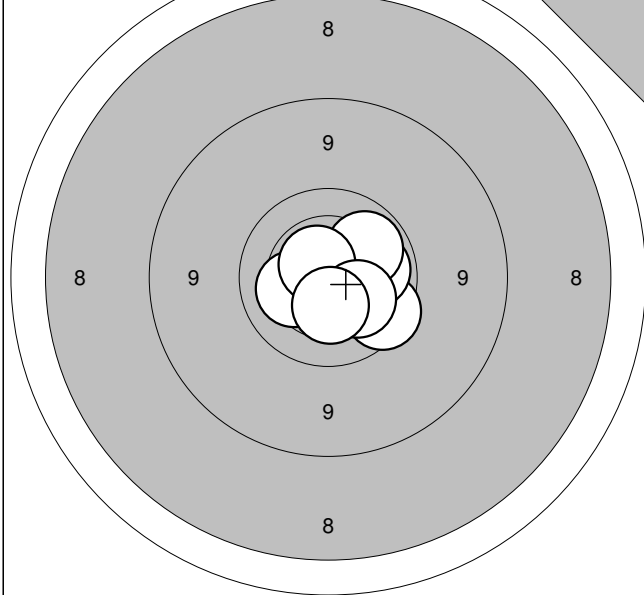

1: 10,2  
 2: 9,8  
 3: 10,1  
 4: 10,0  
 5: 10,6\*  
 6: 10,2  
 7: 10,4

←  
 ↘  
 →  
 ↗  
 ↘  
 ↓

Serie: 69,0

Sum: 0,0

## Gældende

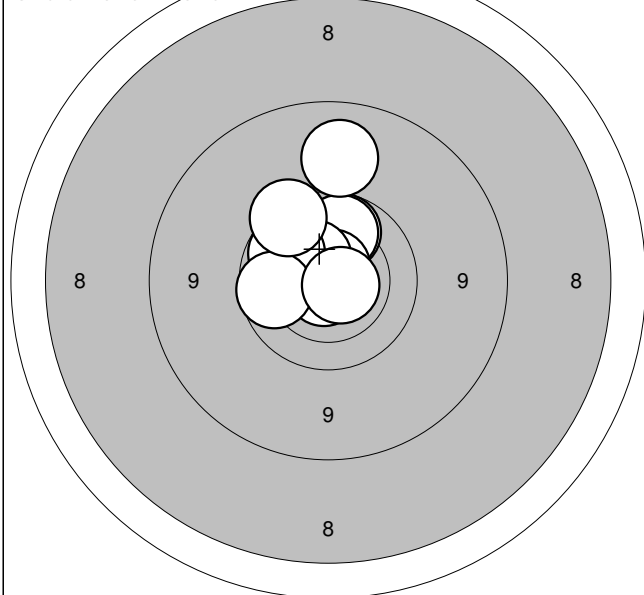

1: 10,0  
 2: 10,8\*  
 3: 10,0  
 4: 10,7\*  
 5: 9,2  
 6: 10,4  
 7: 10,0  
 8: 9,9  
 9: 10,7\*  
 10: 9,7

↑  
 ↓  
 ↑  
 ↑  
 ↑  
 ↗  
 ↗  
 ←  
 ↘  
 ↗

Serie: 97,0

Sum: 97,0

## Gældende

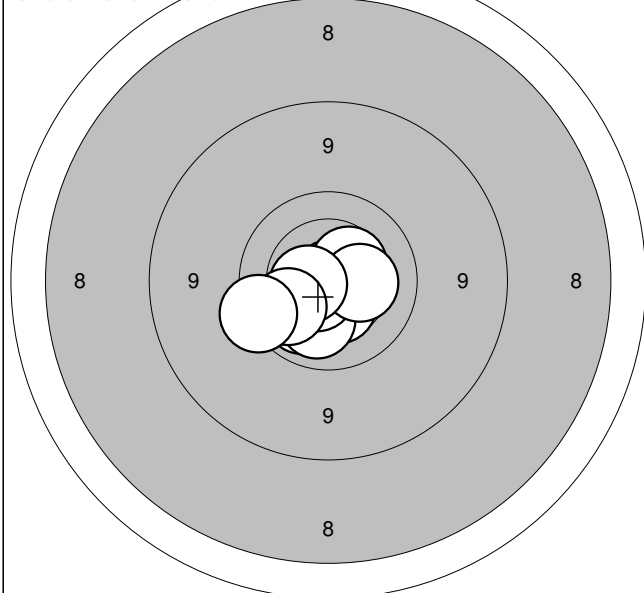

11: 10,9\*  
 12: 10,1  
 13: 10,4  
 14: 10,4  
 15: 10,2  
 16: 10,6\*  
 17: 10,3  
 18: 10,6\*  
 19: 10,0  
 20: 9,7

↗  
 ↓  
 ↓  
 ↗  
 ↓  
 ↓  
 ↘  
 →  
 ←  
 ←  
 ←

Serie: 99,0

Sum: 196,0

Jyllandsstævne 2011

Hold  
**43**Bane  
**9****Thorsten Lindholm**

Mou &amp; Omegns Skf.

BK3

Jyllandsstævne 2011 - riffel

Aalborg Skyttekreds

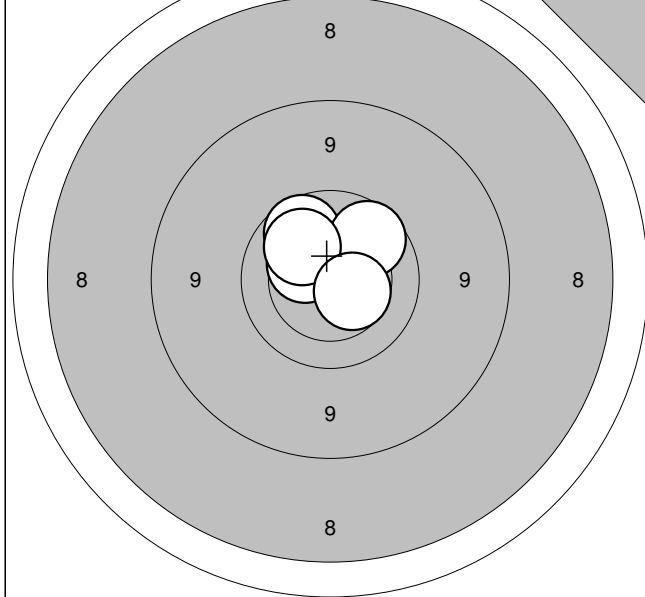
**Prøveskud**

1:	10,4	↗
2:	9,9	↗
3:	9,9	↗
4:	10,1	↗
5:	10,5	↘

Serie:	48,0
Sum:	0,0

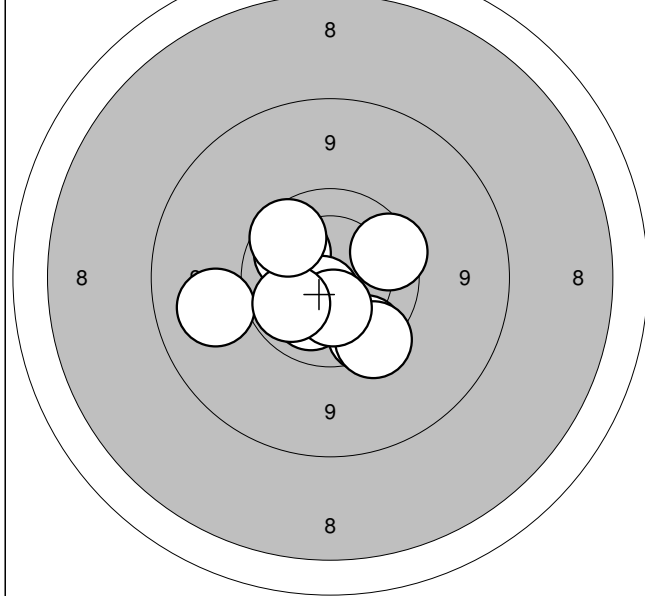
**Gældende**

1:	10,1	↗
2:	10,2	↘
3:	9,8	→
4:	9,8	↘
5:	10,6*	↘
6:	9,2	←
7:	9,7	↘
8:	10,4	↘
9:	10,0	←
10:	9,9	↗

Serie:	95,0
Sum:	95,0

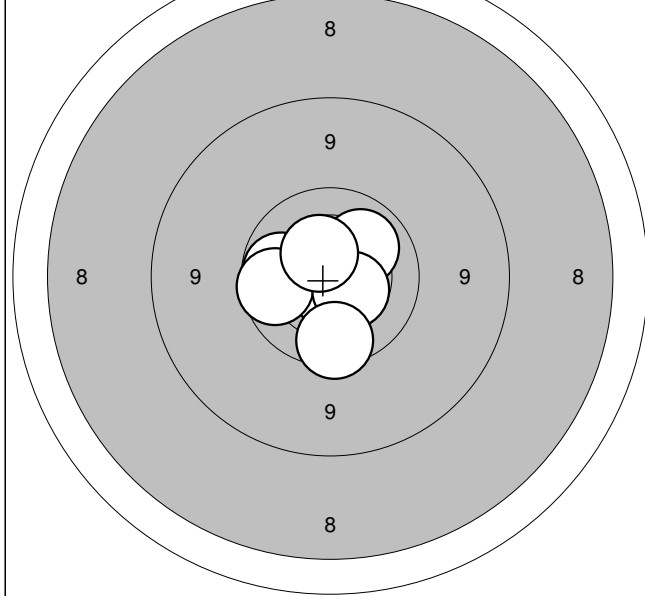
**Gældende**

11:	10,0	←
12:	10,0	←
13:	10,6*	↘
14:	10,6*	→
15:	10,8*	↘
16:	10,1	↗
17:	9,9	←
18:	10,5	↘
19:	10,5	↗
20:	9,8	↘

Serie:	98,0
Sum:	193,0

Jyllandsstævne 2011



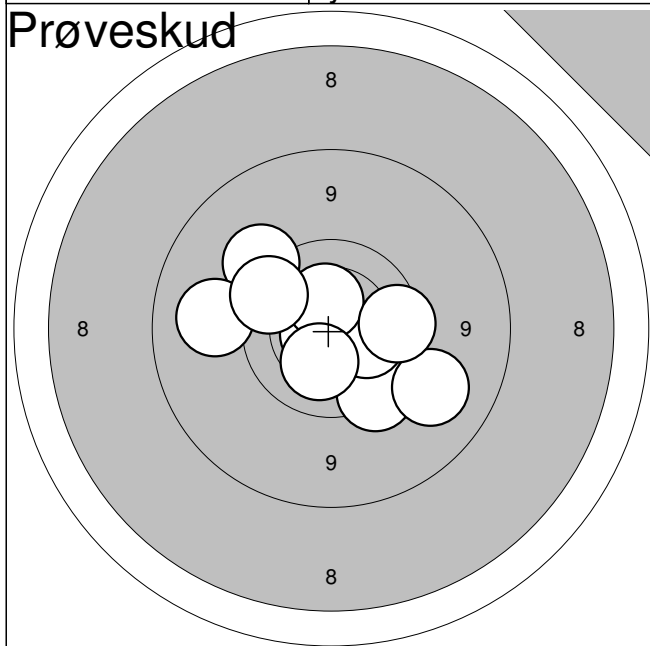

1:	9,6	↘
2:	10,7*	←
3:	9,5	↗
4:	10,2	→
5:	10,4	↑
6:	9,2	↘
7:	9,8	→
8:	10,3	↘
9:	9,2	←
10:	9,7	↗

<b>Serie:</b>	<b>94,0</b>
---------------	-------------

<b>Sum:</b>	<b>0,0</b>
-------------	------------

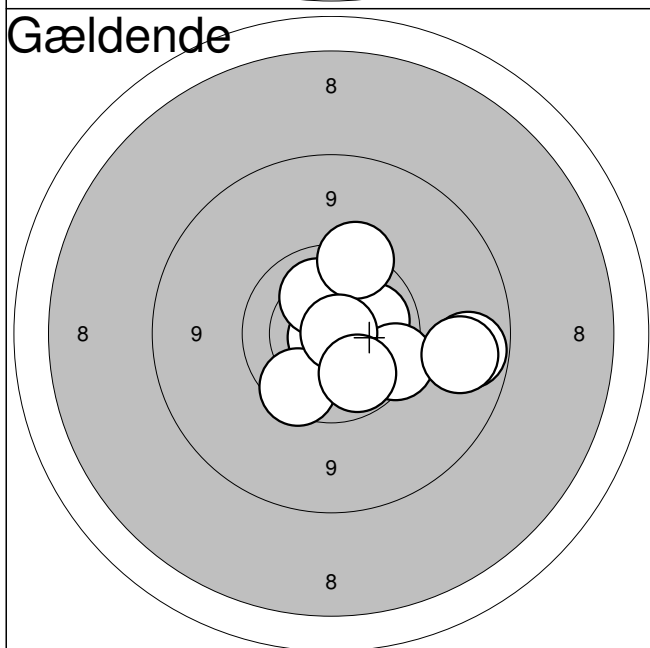

1:	10,8*	↙
2:	10,1	→
3:	9,0	→
4:	10,2	↑
5:	9,8	↘
6:	9,7	↘
7:	9,7	↑
8:	10,8*	→
9:	9,1	→
10:	10,0	↘

<b>Serie:</b>	<b>95,0</b>
---------------	-------------

<b>Sum:</b>	<b>95,0</b>
-------------	-------------

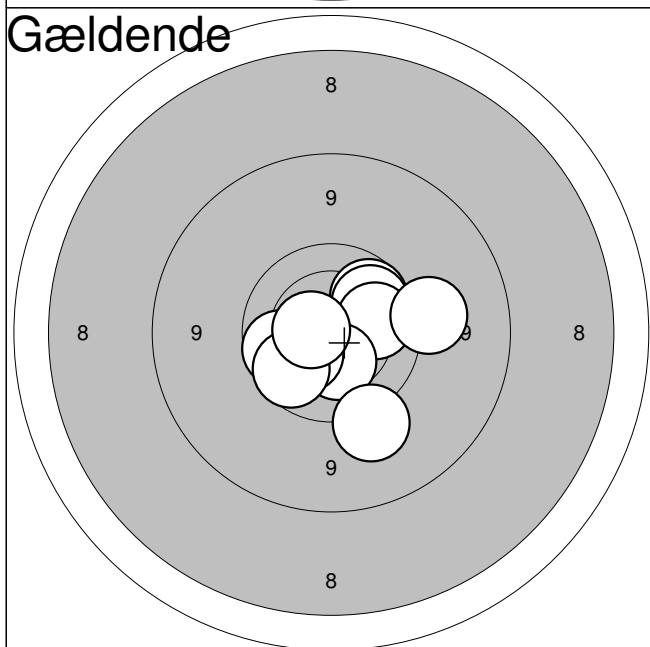

11:	9,9	↗
12:	10,0	↗
13:	10,1	→
14:	10,4	↘
15:	10,3	↘
16:	9,4	↘
17:	9,4	→
18:	9,9	←
19:	9,9	↘
20:	10,6*	←

<b>Serie:</b>	<b>95,0</b>
---------------	-------------

<b>Sum:</b>	<b>190,0</b>
-------------	--------------

Hold  
**43**Bane  
**11****Charlotte Pallisgaard**

Mou &amp; Omegns Skf.

ÅK3

Jyllandsstævne 2011 - riffel

Aalborg Skyttekreds

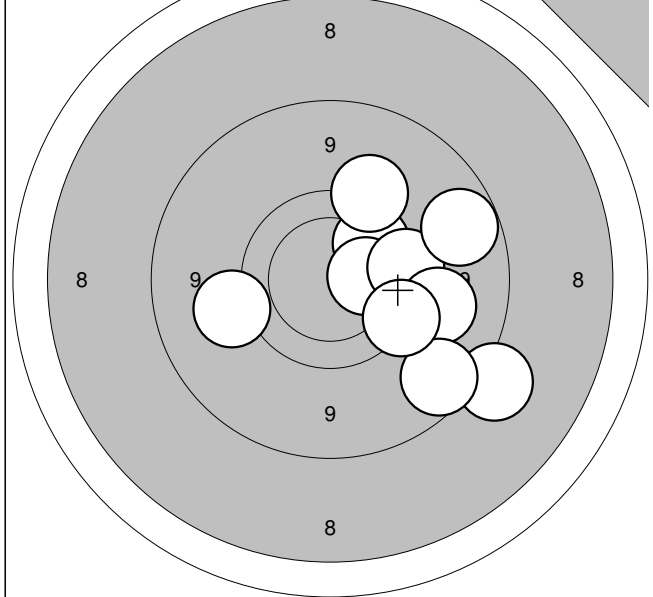
**Prøveskud**

1:	9,9	↗
2:	10,2	→
3:	8,6	↘
4:	9,4	←
5:	9,7	→
6:	9,3	→
7:	9,0	→
8:	9,5	↗
9:	8,9	↘
10:	9,6	↘

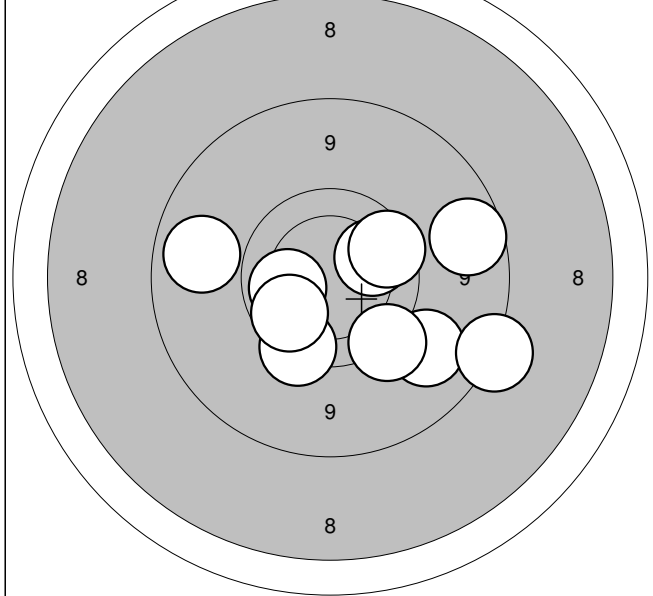
Serie: **89,0**Sum: **0,0****Gældende**

1:	10,0	→
2:	9,2	↘
3:	8,7	↘
4:	10,1	←
5:	9,7	↘
6:	9,8	→
7:	9,5	↘
8:	8,9	→
9:	9,9	↘
10:	9,1	←

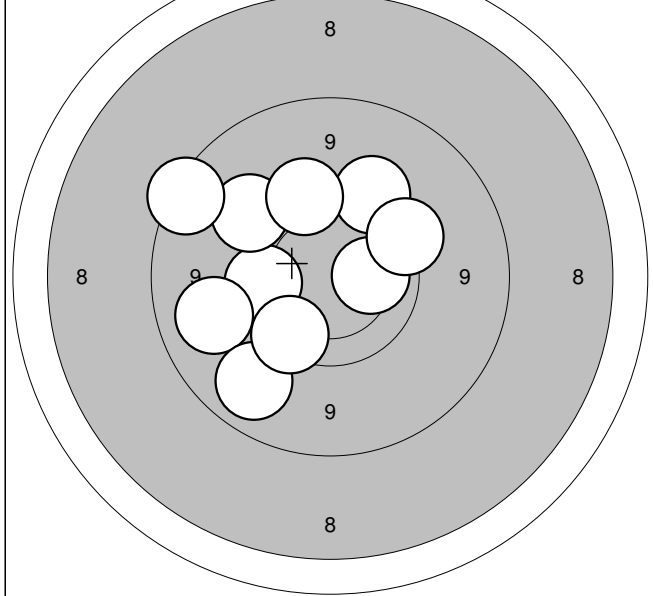
Serie: **90,0**Sum: **90,0****Gældende**

11:	10,2	→
12:	9,8	←
13:	9,2	←
14:	9,1	↘
15:	9,4	↗
16:	9,5	↗
17:	9,6	↗
18:	8,8	↗
19:	9,6	→
20:	9,7	↘

Serie: **90,0**Sum: **180,0**

Jyllandsstævne 2011

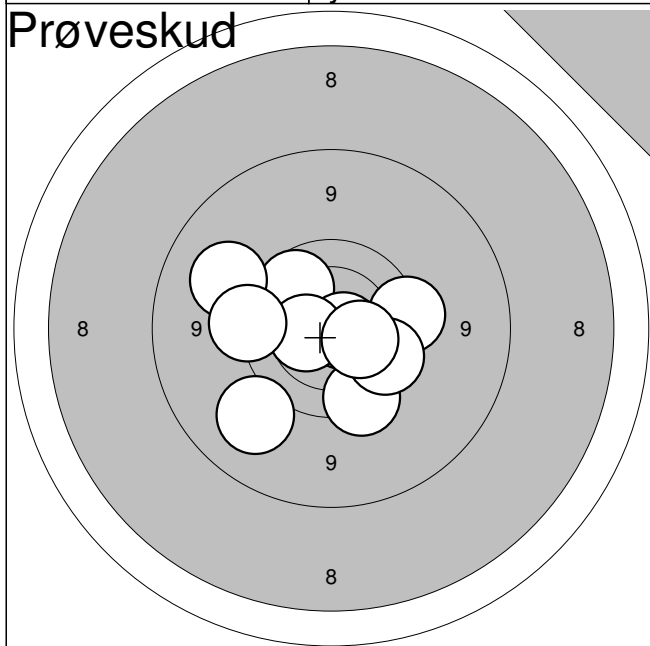

1:	9,2	↙
2:	9,7	→
3:	9,9	↗
4:	9,3	↖
5:	10,7*	→
6:	10,5	←
7:	9,7	↘
8:	9,6	←
9:	9,8	↘
10:	10,3	→

Serie:	<b>93,0</b>
--------	-------------

Sum:	<b>0,0</b>
------	------------

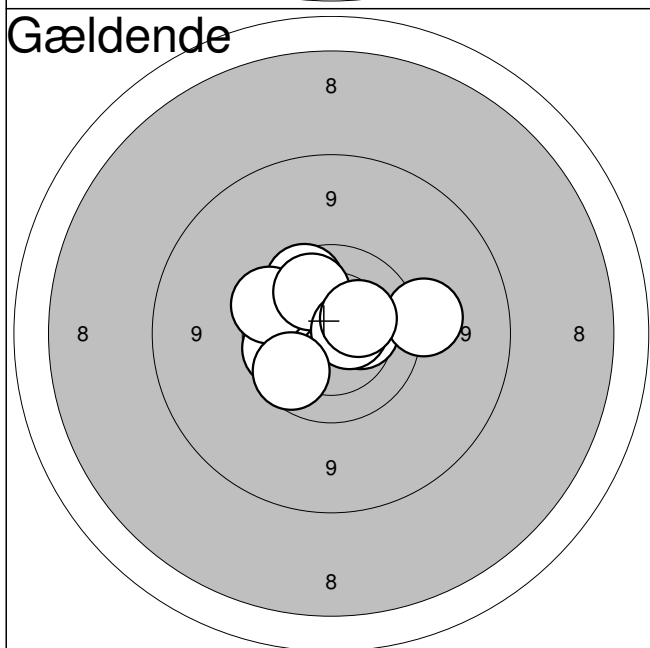

1:	9,9	←
2:	10,4	→
3:	9,5	→
4:	9,9	↗
5:	9,9	↖
6:	9,8	↖
7:	10,1	↗
8:	10,6*	→
9:	10,3	↗
10:	9,9	↘

Serie:	<b>94,0</b>
--------	-------------

Sum:	<b>94,0</b>
------	-------------

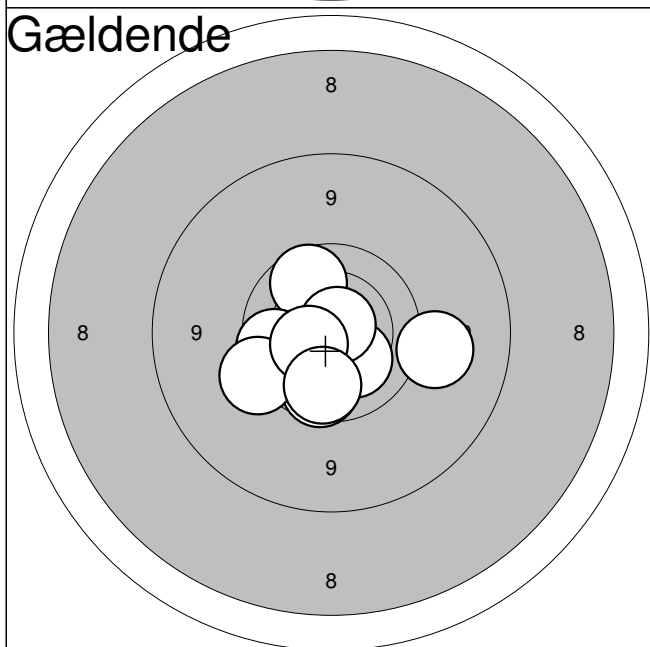

11:	9,3	→
12:	10,6*	↘
13:	10,3	↘
14:	9,9	↗
15:	9,9	←
16:	9,9	↘
17:	9,6	←
18:	10,8*	↗
19:	10,5	←
20:	9,9	↘

Serie:	<b>94,0</b>
--------	-------------

Sum:	<b>188,0</b>
------	--------------

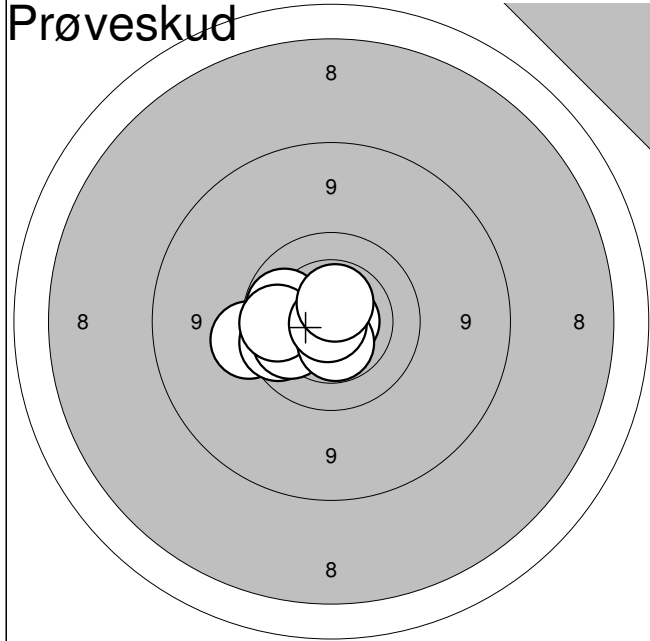

1:	9,6	←
2:	9,9	←
3:	10,1	←
4:	10,0	←
5:	10,8*	↓
6:	10,8*	→
7:	9,9	←
8:	10,5*	↓
9:	10,9*	↙
10:	10,6*	↑
<b>Serie:</b>		<b>97,0</b>
<b>Sum:</b>		<b>0,0</b>

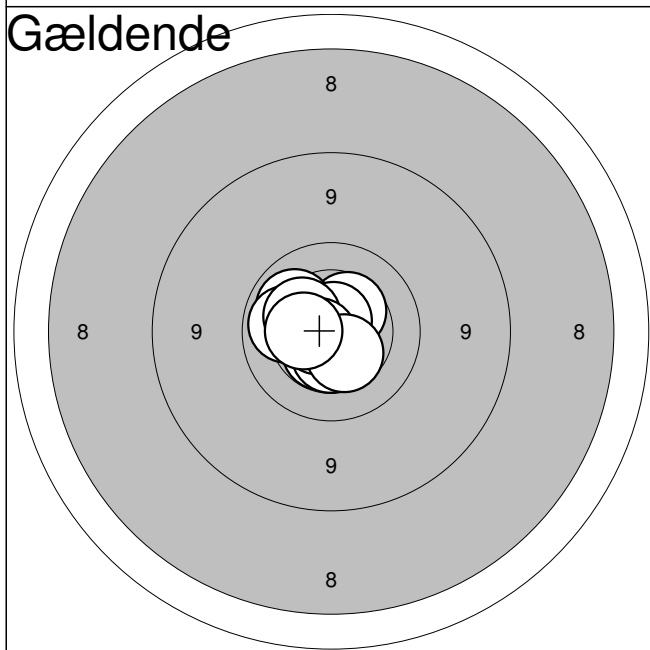

1:	10,4	↗
2:	10,1	↖
3:	10,5*	↓
4:	10,1	←
5:	10,5*	↓
6:	10,7*	↑
7:	10,3	↖
8:	10,7*	←
9:	10,4	↓
10:	10,4	←
<b>Serie:</b>		<b>100,0</b>
<b>Sum:</b>		<b>100,0</b>

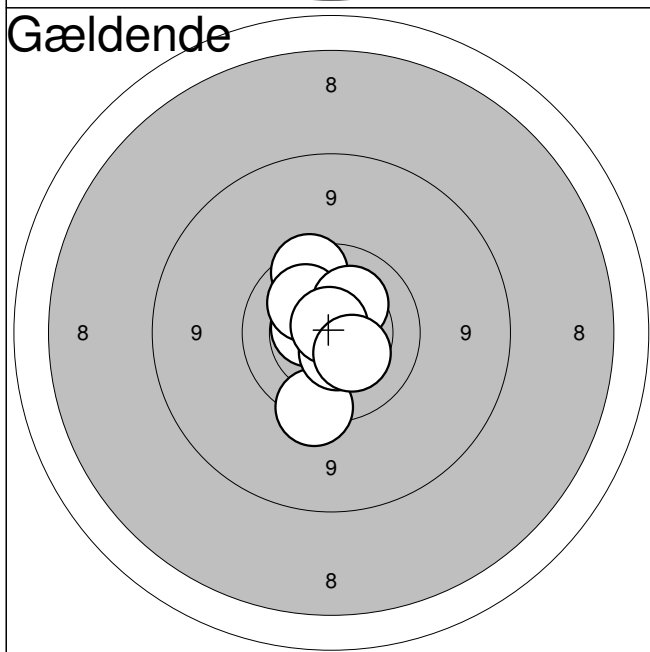

11:	10,9*	↗
12:	9,7	↓
13:	10,5*	←
14:	9,8	↑
15:	10,6*	↓
16:	10,6*	↑
17:	10,2	↗
18:	10,3	↗
19:	10,8*	↑
20:	10,4	↓
<b>Serie:</b>		<b>98,0</b>
<b>Sum:</b>		<b>198,0</b>

Hold  
**44**

Bane  
**2**

# Dennis Nielsen

Ulsted Skf.

2

Jyllandsstævne 2011 - riffel

Aalborg Skyttekreds

Prøveskud

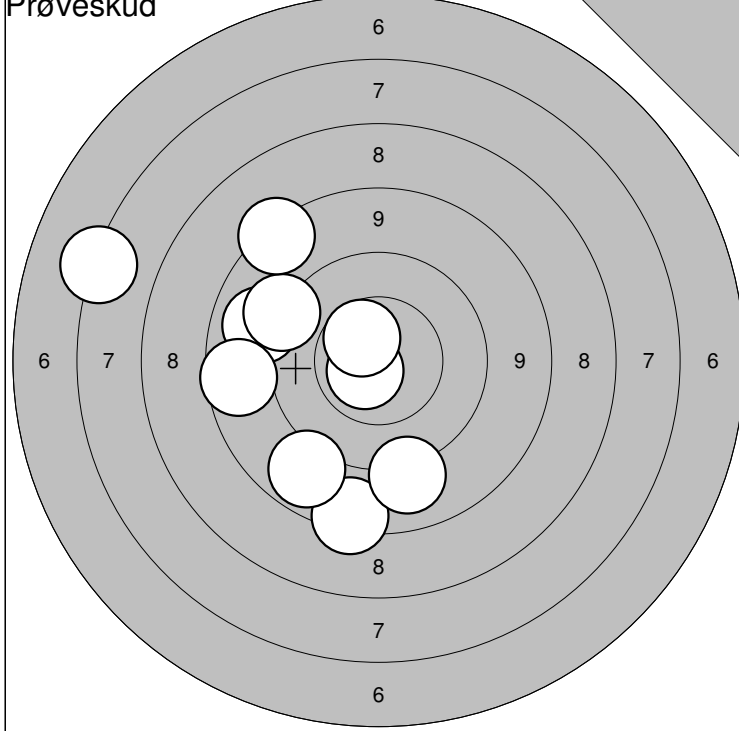

Prøveskud

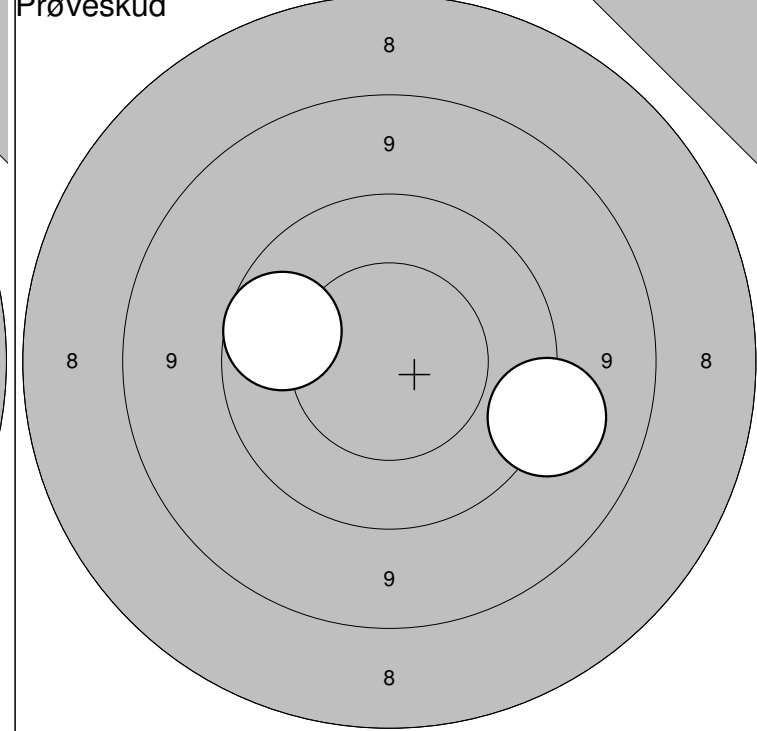

1: 6,5 ↙  
 2: 8,6 ↓  
 3: 9,1 ↖  
 4: 9,2 ↓  
 5: 9,4 ↖

6: 8,9 ←  
 7: 9,0 ↓  
 8: 10,7\* ↙  
 9: 8,6 ↗  
 10: 10,6 ↗

Serie: 86,0  
 Sum: 0,0

11: 9,4 ↗  
 12: 9,9 ↖

Serie: 18,0  
 Sum: 0,0

Gældende

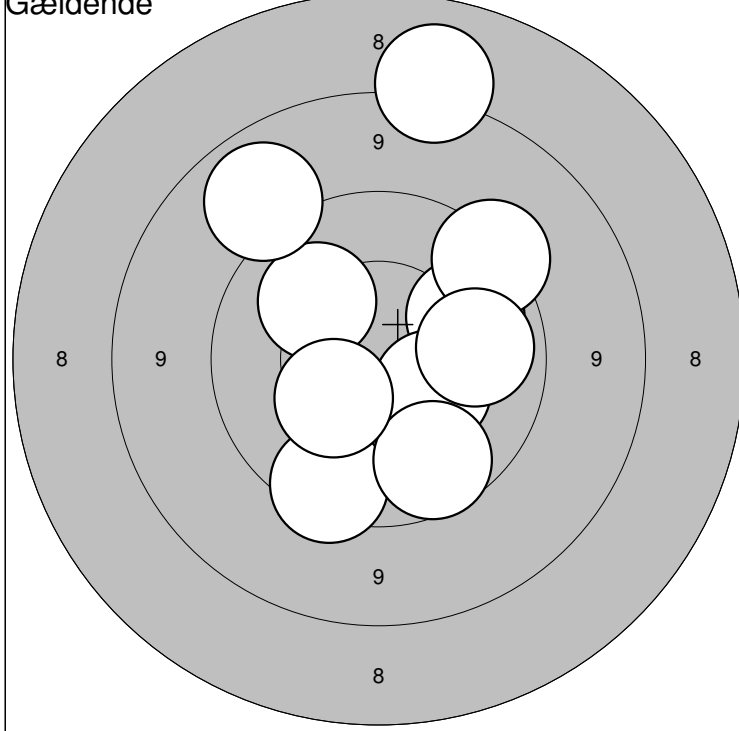

Gældende

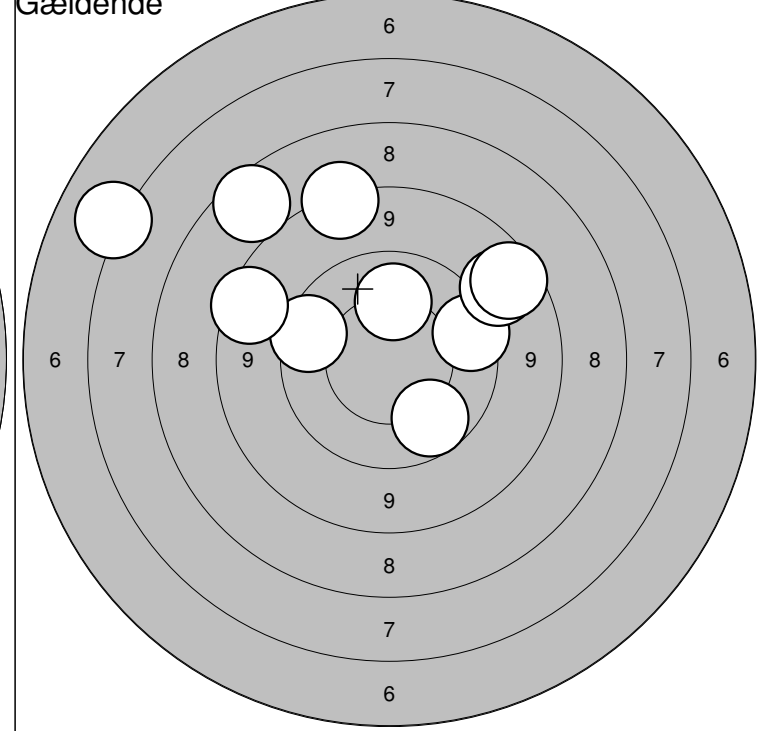

1: 10,1 ↗  
 2: 10,4 ↘  
 3: 9,7 ↓  
 4: 9,9 ↓  
 5: 8,2 ↑

6: 9,5 ↗  
 7: 10,2 ↖  
 8: 10,1 →  
 9: 10,4 ↖  
 10: 9,1 ↗

Serie: 94,0  
 Sum: 94,0

11: 9,9 ↘  
 12: 10,1 ↑  
 13: 9,7 →  
 14: 9,0 ↗  
 15: 6,2 ↖

16: 8,5 ↑  
 17: 7,8 ↖  
 18: 9,7 ↖  
 19: 8,7 ↖  
 20: 8,8 ↗

Serie: 83,0  
 Sum: 177,0

Jyllandsstævne 2011

Hold

44

Bane

3

## Louise Bedsted

Vester Han Herred Skytteforeni

2

Jyllandsstævne 2011 - riffel

Aalborg Skyttekreds

## Prøveskud

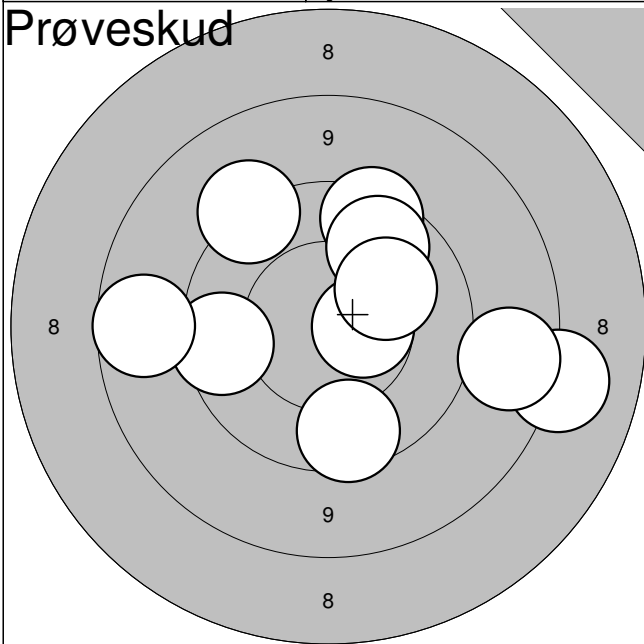

1:	9,8	←
2:	8,3	→
3:	8,9	→
4:	9,8	↓
5:	8,9	←
6:	9,7	↑
7:	10,6	→
8:	10,0	↗
9:	9,4	↗
10:	10,2	↗

Serie: 90,0

Sum: 0,0

## Gældende

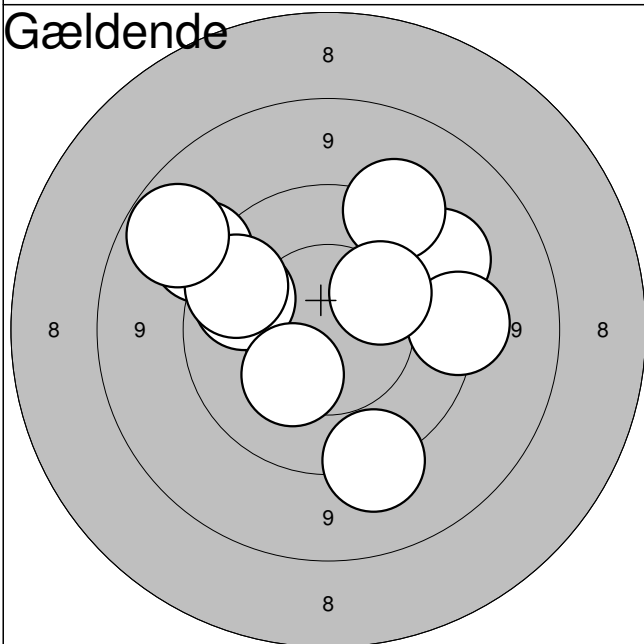

1:	9,5	↗
2:	9,5	↗
3:	10,0	←
4:	9,3	↗
5:	9,4	↓
6:	9,9	↗
7:	10,3	↓
8:	9,5	→
9:	9,0	↗
10:	10,3	↗

Serie: 93,0

Sum: 93,0

## Gældende

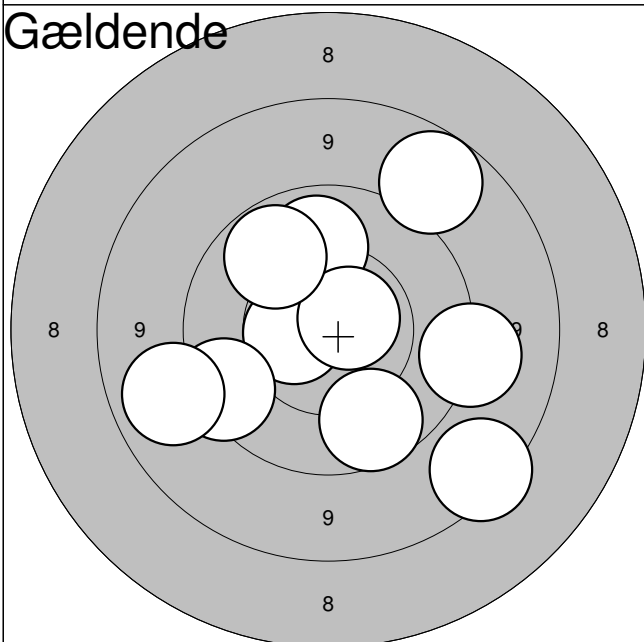

11:	10,6*	←
12:	9,9	↓
13:	10,1	↑
14:	9,7	←
15:	9,4	→
16:	10,7*	↗
17:	9,0	↗
18:	8,6	↓
19:	10,0	↗
20:	9,1	←

Serie: 93,0

Sum: 186,0

Jyllandsstævne 2011

Hold

44

Bane

4

## Ann-Berit Bedsted

Vester Han Herred Skytteforeni

ÅK2

Jyllandsstævne 2011 - riffel

Aalborg Skyttekreds

## Prøveskud

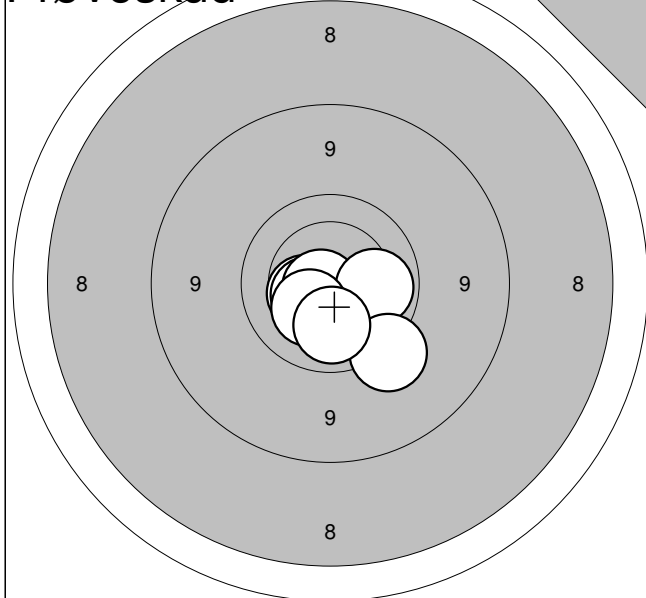

1: 10,4



2: 10,5



3: 10,8\*



4: 10,1



5: 9,5



6: 10,3



7: 10,1



Serie:

69,0

Sum:

0,0

## Gældende

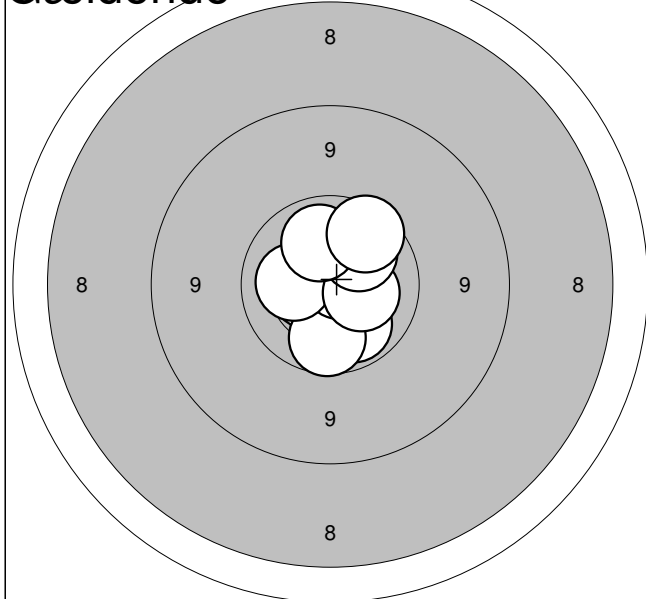

1: 10,5\*



2: 10,0



3: 9,9



4: 10,2



5: 10,7\*



6: 10,2



7: 10,3



8: 10,1



9: 10,1



10: 9,8



Serie:

98,0

Sum:

98,0

## Gældende

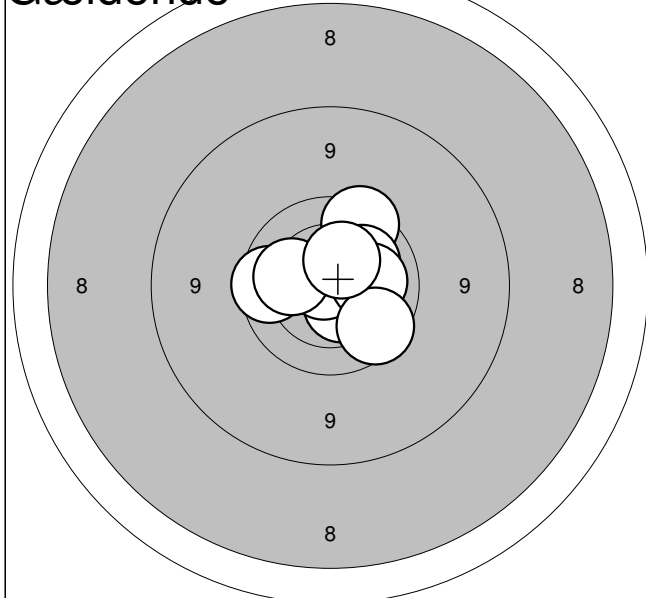

11: 10,7\*



12: 9,8



13: 10,2



14: 10,5\*



15: 10,8\*



16: 9,9



17: 10,2



18: 10,2



19: 9,8



20: 10,4



Serie:

97,0

Sum:

195,0

Jyllandsstævne 2011

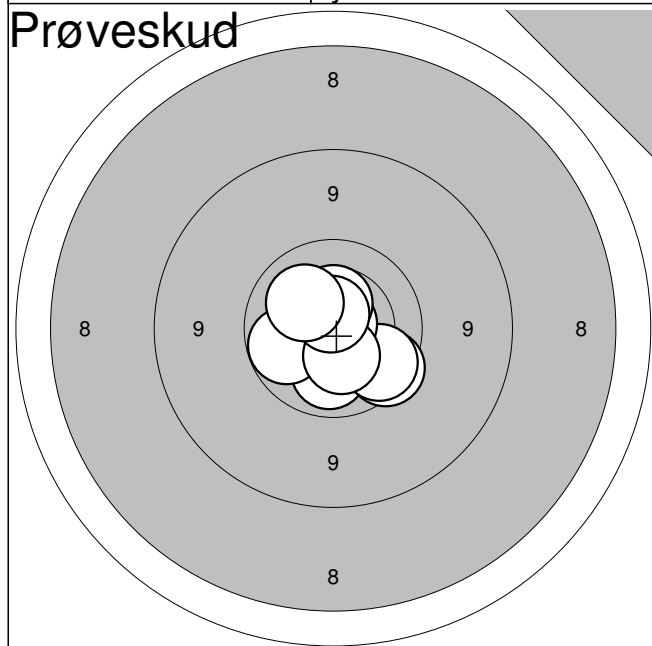

1:	10,1	↓
2:	9,8	↘
3:	10,7*	↑
4:	9,9	↘
5:	10,8*	↗
6:	10,0	←
7:	10,5	↑
8:	10,4	↓
9:	10,7*	↑
10:	10,2	↗

**Serie: 98,0**

**Sum: 0,0**

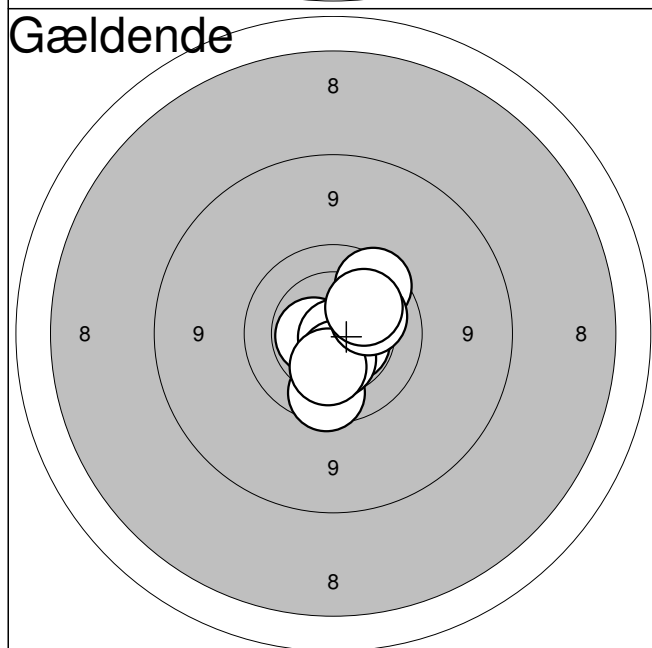

1:	10,3	↗
2:	10,6*	←
3:	10,5*	↘
4:	10,8*	↓
5:	9,8	↗
6:	9,9	↓
7:	10,4	↓
8:	10,3	↓
9:	10,2	↗
10:	10,2	↗

**Serie: 98,0**

**Sum: 98,0**

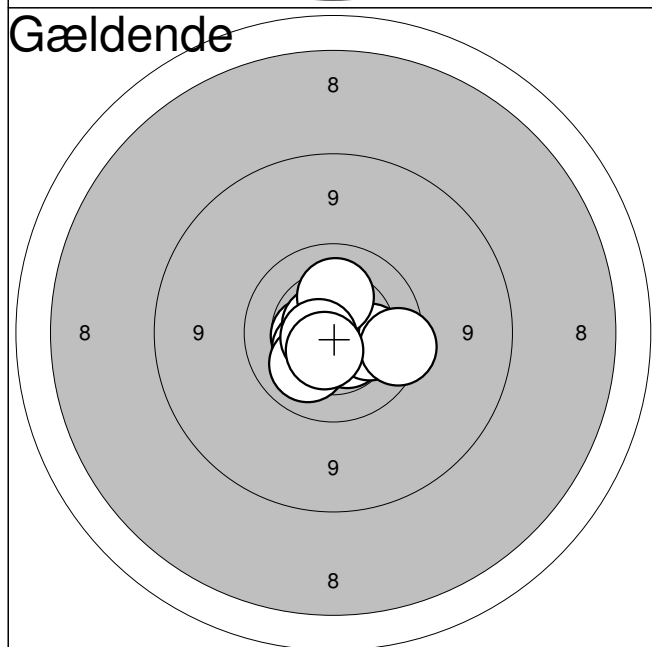

11:	10,5*	↘
12:	10,5	←
13:	10,2	↗
14:	10,4	↘
15:	10,2	↘
16:	10,7*	↖
17:	10,3	↑
18:	10,7*	←
19:	9,8	↗
20:	10,6*	↓

**Serie: 99,0**

**Sum: 197,0**



Hold  
**44**Bane  
**6****Simon Andersen**

Vilsted Skf.

BK1

Jyllandsstævne 2011 - riffel

Aalborg Skyttekreds

Prøveskud

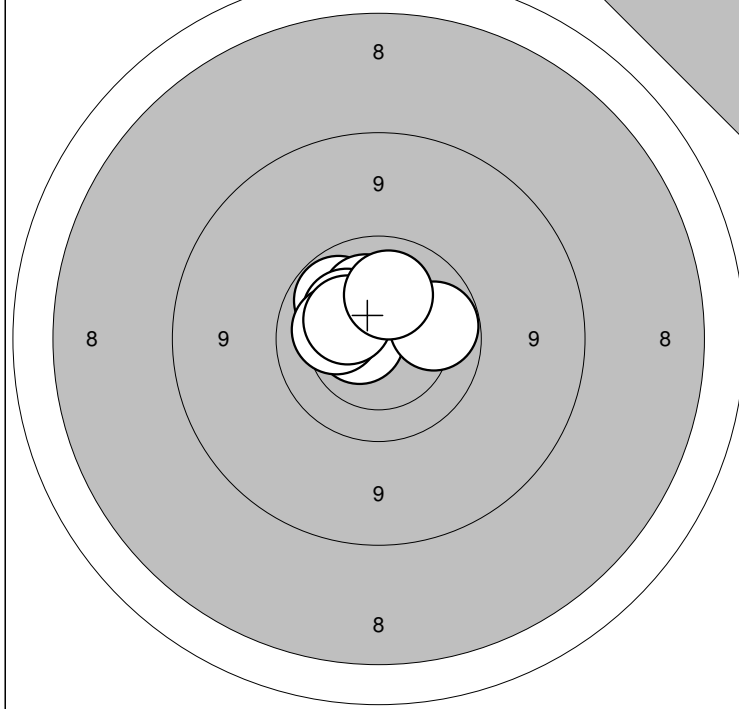

Prøveskud

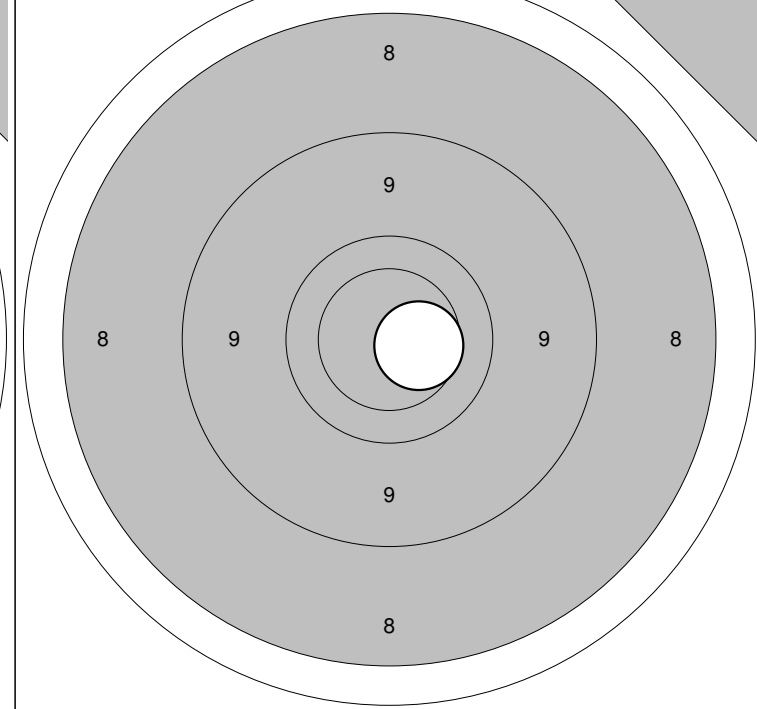

1:10,3 ↑  
2:10,0 ↘  
3:10,7\* ↘  
4:10,6\* ←  
5:10,2 ↑

6:10,0 →  
7:10,3 ↘  
8:10,2 ←  
9:10,3 ↘  
10:10,2 ↑

Serie: 100,0

Sum: 0,0

11:10,4 →

Serie: 10,0

Sum: 0,0

Gældende

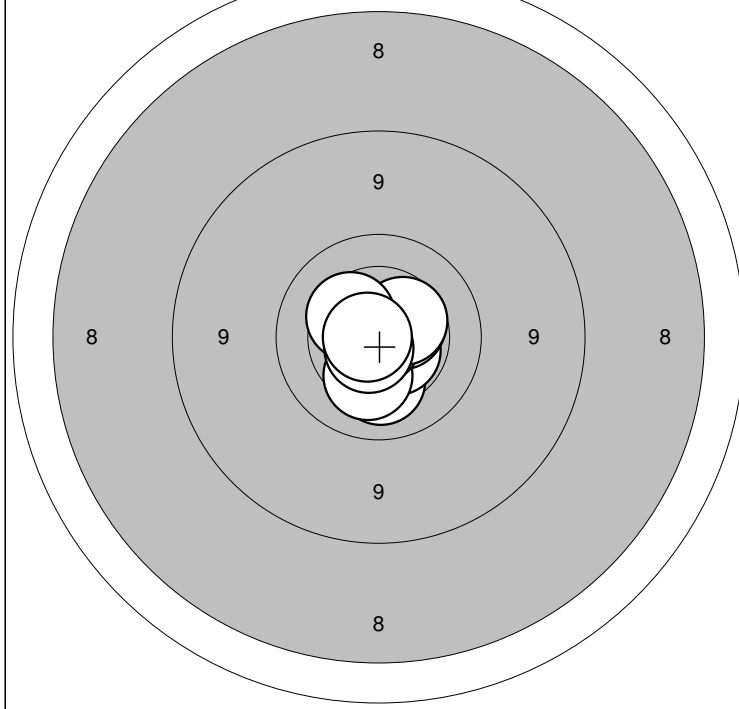

Gældende

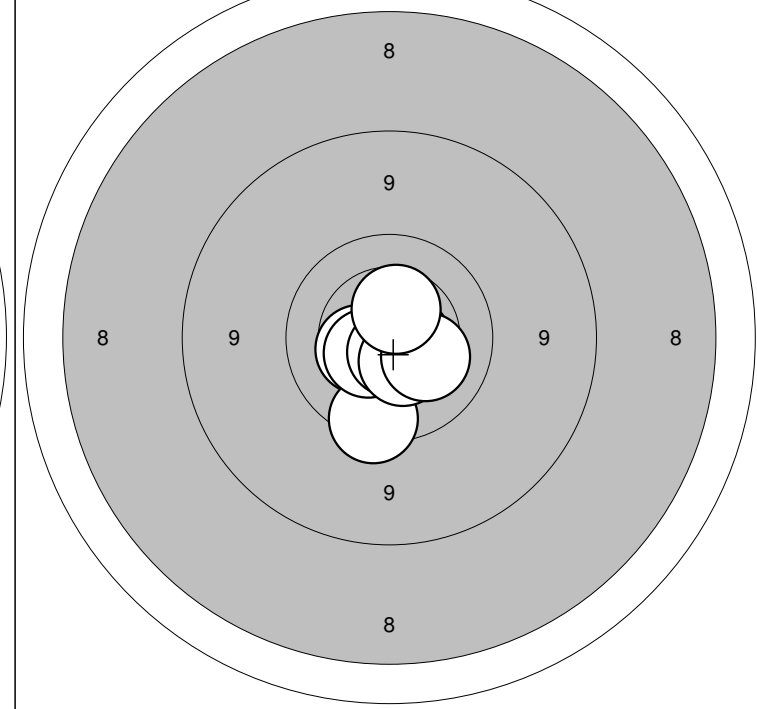

1:10,3 ↓  
2:10,2 ↓  
3:10,6\* ↘  
4:10,3 ↓  
5:10,5\* →

6:10,9\* ↓  
7:10,5 ↘  
8:10,4 ↘  
9:10,7\* ↓  
10:10,8\* ←

Serie: 100,0

Sum: 100,0

11:10,5\* ↘  
12:10,4 ←  
13:10,6\* ↘  
14: 9,7 ↓  
15:10,5\* ←

16:10,6\* →  
17:10,7\* ↓  
18:10,5 ↓  
19:10,3 ↘  
20:10,5 ↑

Serie: 99,0

Sum: 199,0

Jyllandsstævne 2011

Hold  
**44**Bane  
**7****Morten Aagaard Christensen**

Vilsted Skf.

ÅK2

Jyllandsstævne 2011 - riffel

Aalborg Skyttekreds

Prøveskud

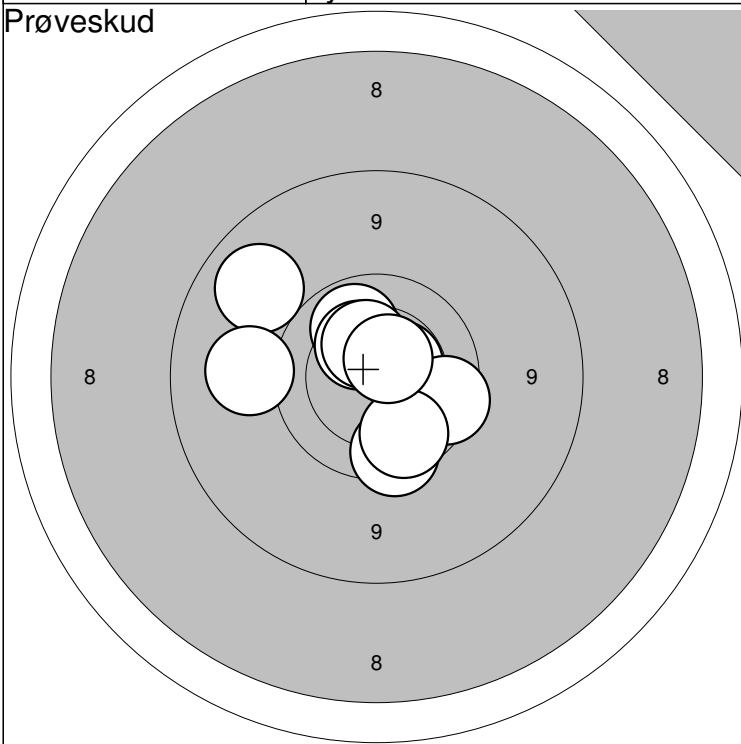

Prøveskud

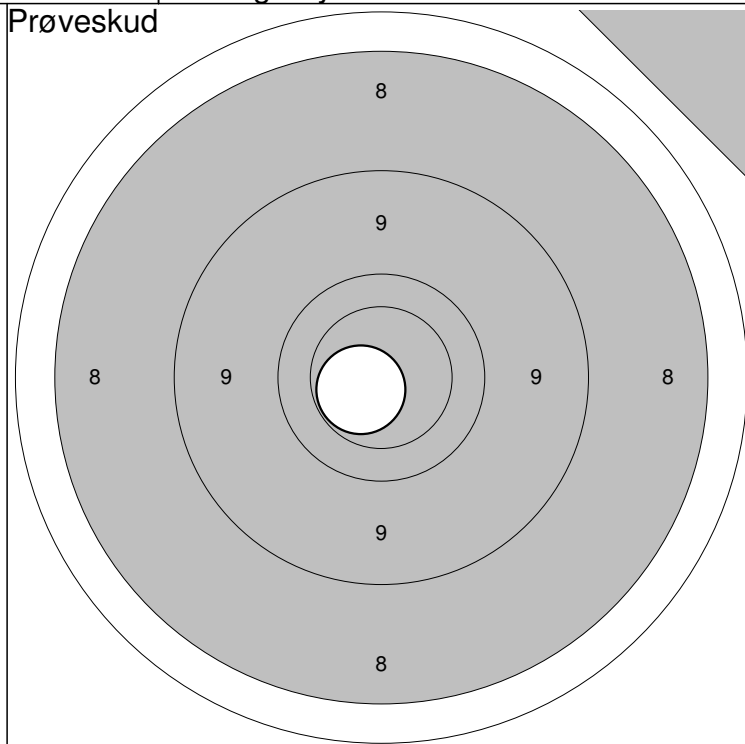

1: 9,1 ↗

2: 9,3 ←

3: 9,8 ↓

4:10,1 ↗

5:10,3 ↗

6:10,5\* ↗

7: 9,8 →

8:10,4 ↗

9: 9,9 ↓

10:10,6\* ↗

Serie: 95,0

Sum: 0,0

11:10,6\* ↙

Serie: 10,0

Sum: 0,0

Gældende

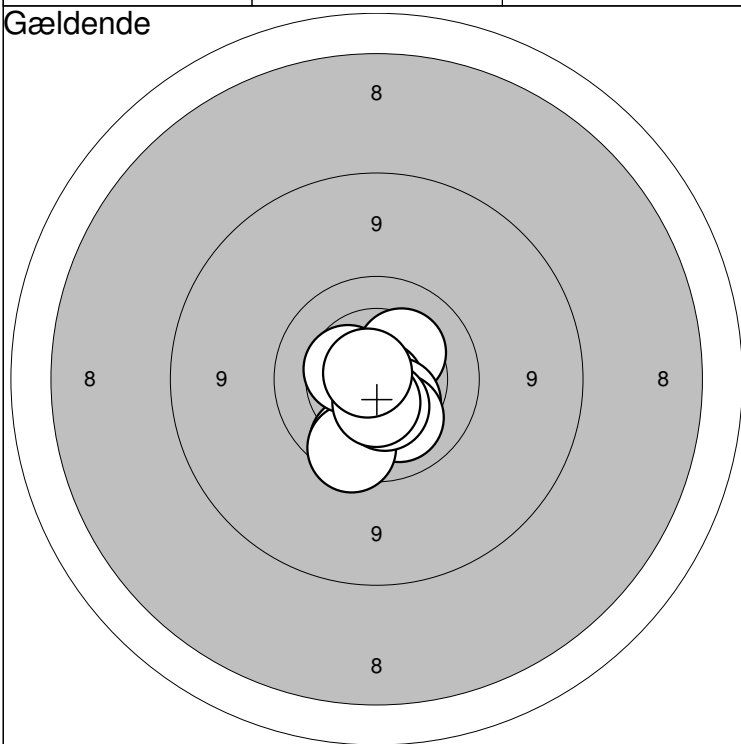

Gældende

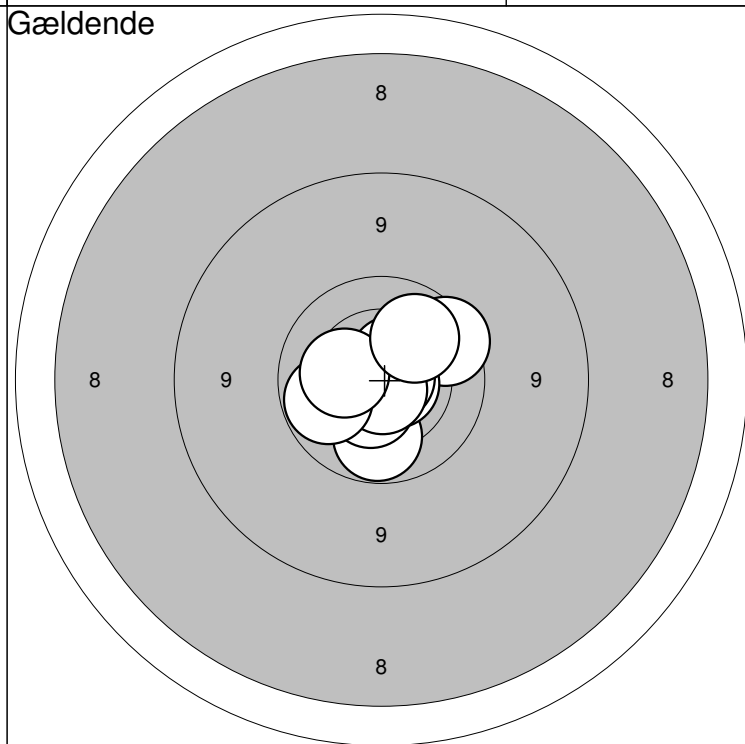

1:10,3 ↗

2: 9,9 ↓

3:10,8\* ↓

4:10,4 ↓

5:10,2 ↓

6: 9,8 ↓

7:10,5 ↓

8:10,4 ←

9:10,5\* ↓

10:10,8\* ↗

Serie: 98,0

Sum: 98,0

11: 9,8 ↗

12:10,0 ↓

13:10,6\* ↗

14:10,5\* ↓

15:10,7\* →

16:10,8\* →

17:10,8\* ↓

18:10,0 ←

19:10,3 ←

20:10,0 ↗

Serie: 99,0

Sum: 197,0

Jyllandsstævne 2011

Hold  
**44**

Bane  
**8**

# Christian Pallisgaard

Mou & Omegns Skf.

BK3

Jyllandsstævne 2011 - riffel

Aalborg Skyttekreds

Prøveskud

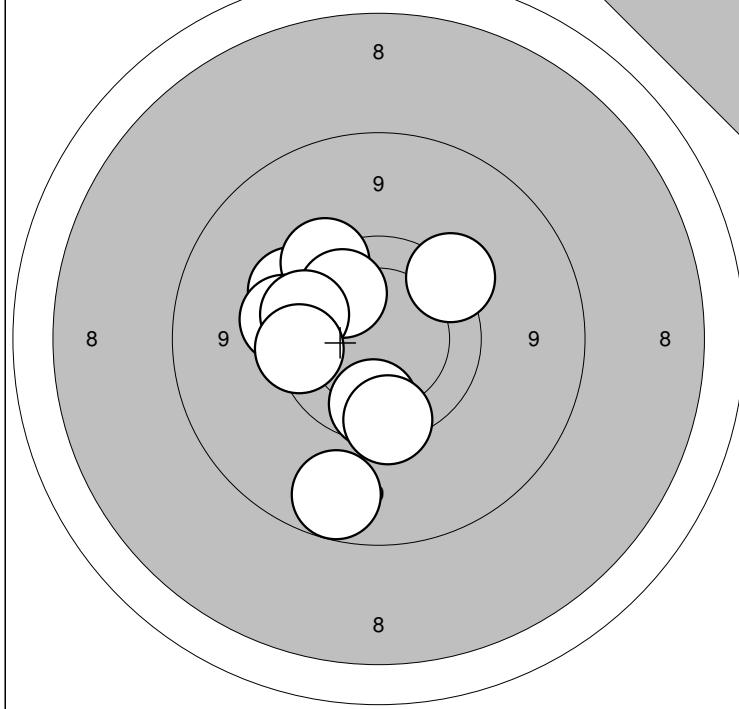

Prøveskud

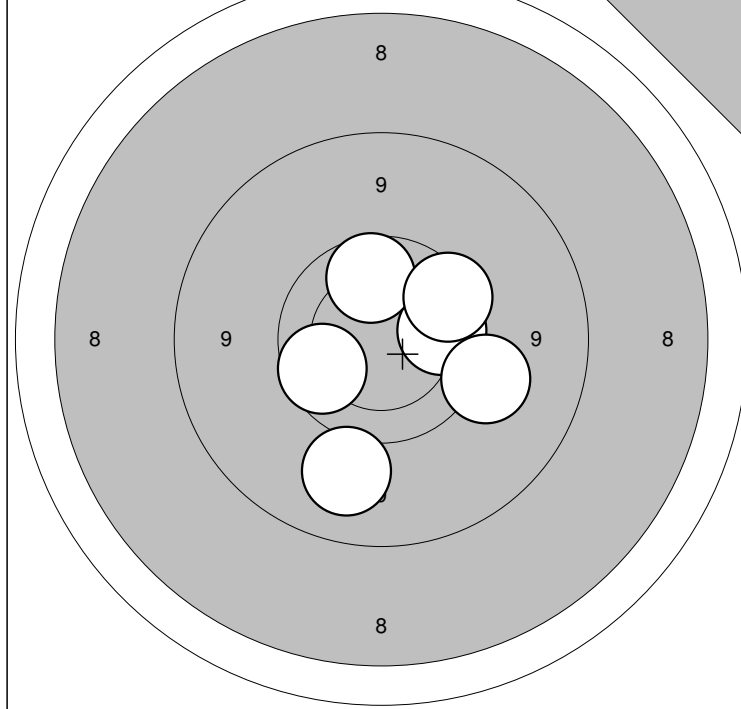

1: 9,6 ↖	6: 9,8 ←
2: 9,6 ↗	7: 9,7 ←
3: 9,0 ↓	8: 9,9 ↓
4: 9,6 ←	9: 9,6 ↗
5: 10,0 ↖	10: 9,7 ↓

Serie:	91,0
Sum:	0,0

11: 9,9 →	16: 9,2 ↓
12: 9,9 ↑	
13: 9,8 ↗	
14: 9,9 ←	
15: 9,4 →	

Serie:	54,0
Sum:	0,0

Gældende

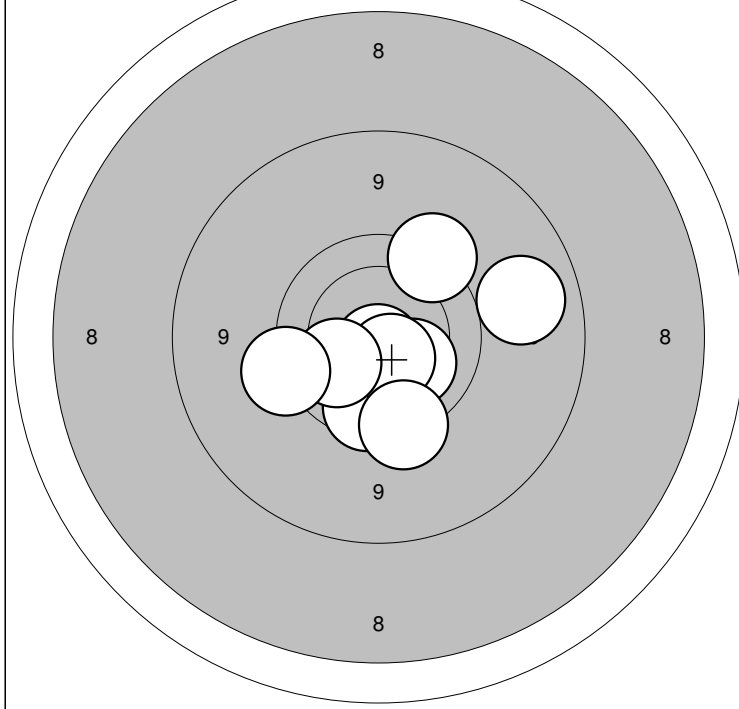

Gældende

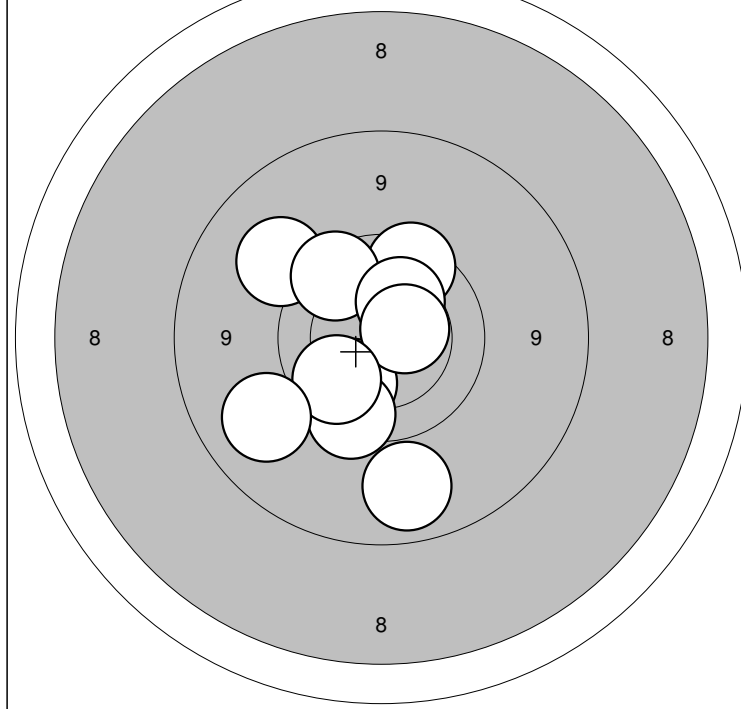

1: 9,9 ↓	6: 10,5* ↓
2: 10,8* ↓	7: 10,1 ←
3: 9,1 →	8: 9,6 ←
4: 9,8 ↓	9: 9,6 ↗
5: 10,2 ↘	10: 9,6 ↓

Serie:	94,0
Sum:	94,0

11: 10,0 ↘	16: 9,1 ↓
12: 9,8 ↗	17: 10,3 ↗
13: 9,7 ↓	18: 10,5* →
14: 9,3 ↖	19: 9,9 ↙
15: 9,8 ↖	20: 9,2 ↙

Serie:	93,0
Sum:	187,0

## Prøveskud

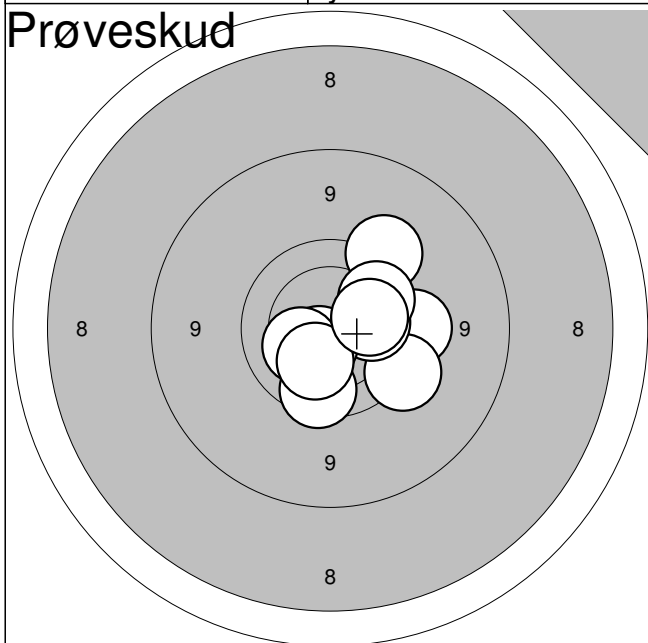

1:	9,6	→
2:	9,6	↘
3:	10,1	→
4:	10,6*	↘
5:	10,3	↙
6:	9,5	↗
7:	9,9	↗
8:	9,8	↓
9:	10,2	↘
10:	10,1	→

Serie: 95,0

Sum: 0,0

## Gældende

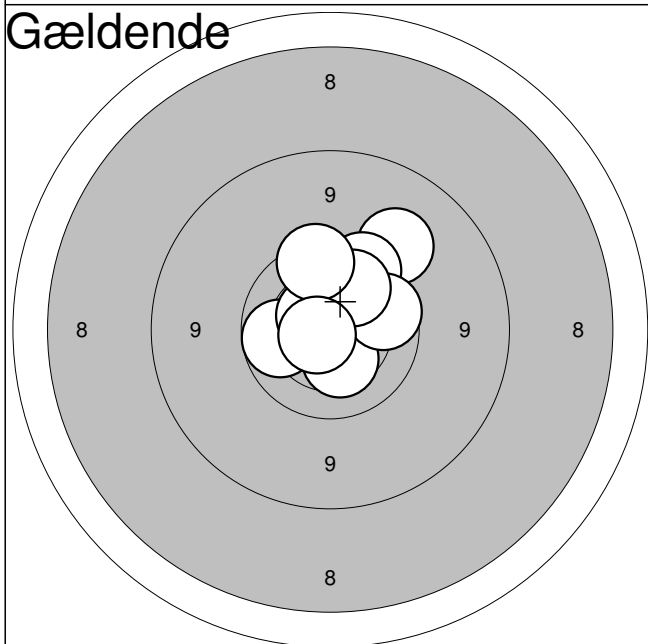

1:	10,3	↓
2:	9,3	↗
3:	10,0	←
4:	10,1	↑
5:	9,8	↗
6:	10,5*	↗
7:	9,9	→
8:	10,0	↗
9:	9,8	↑
10:	10,7*	←

Serie: 96,0

Sum: 96,0

## Gældende

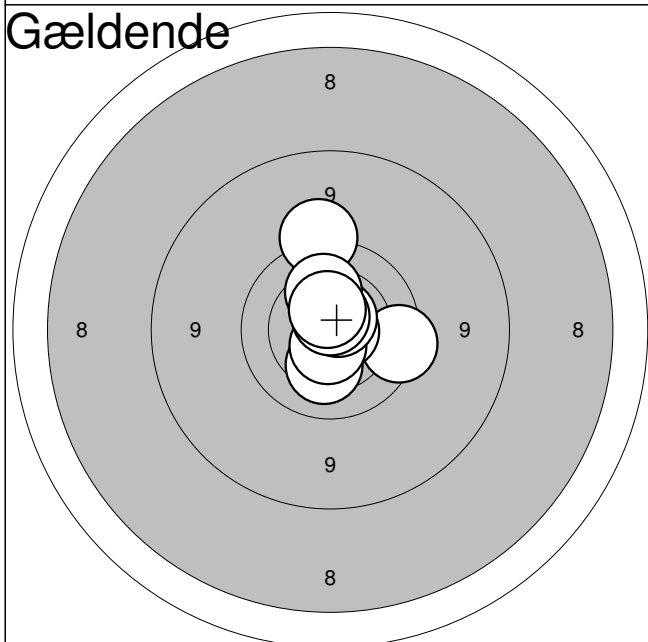

11:	9,7	→
12:	10,9*	↘
13:	10,7*	→
14:	10,2	↓
15:	10,6*	↓
16:	9,5	↑
17:	10,7*	↗
18:	10,2	↑
19:	10,7*	↑
20:	10,6*	↑

Serie: 98,0

Sum: 194,0

Hold

44

Bane

10

Anna Sloth Borregaard

Mou &amp; Omegns Skf.

BK3

Jyllandsstævne 2011 - riffel

Aalborg Skyttekreds

Prøveskud

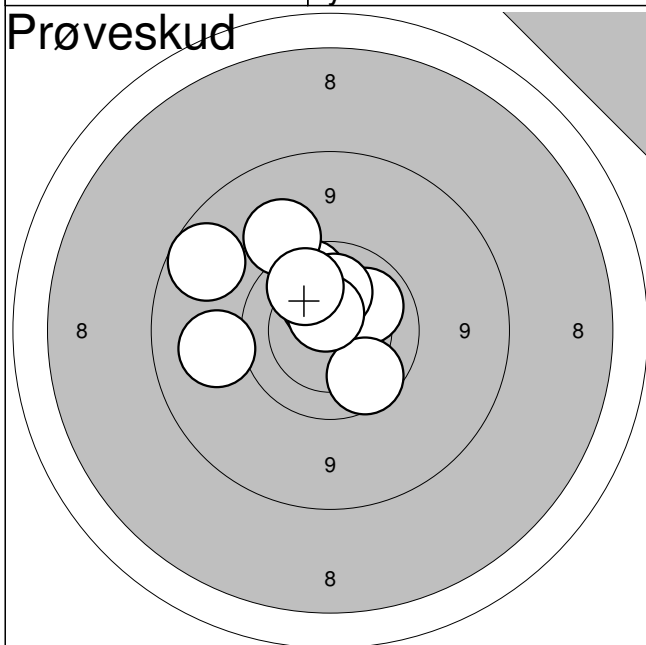

1:	9,0	↖
2:	9,9	↗
3:	9,4	↗
4:	10,1	↗
5:	9,9	↘
6:	10,4	↗
7:	10,2	↗
8:	10,6*	↗
9:	9,2	↖
10:	10,0	↗

Serie: 95,0

Sum: 0,0

Gældende

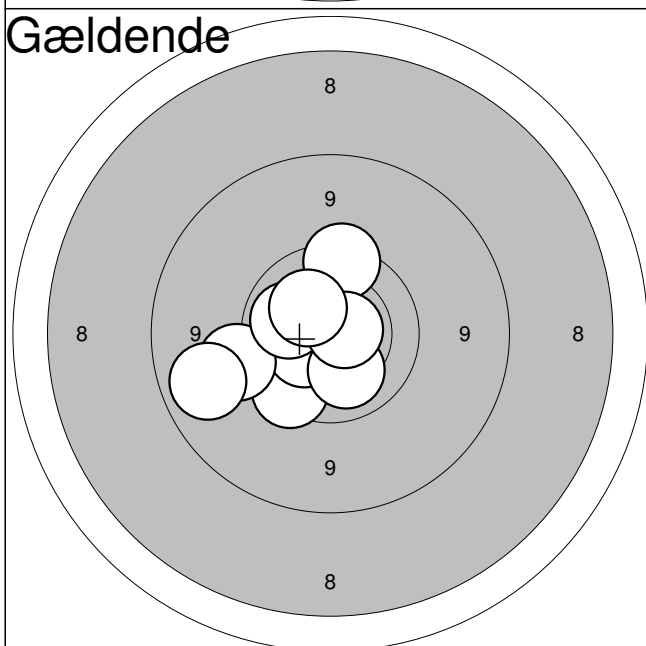

1:	9,7	↗
2:	10,6*	↗
3:	9,7	↘
4:	10,4	↖
5:	9,4	↖
6:	9,1	↖
7:	10,1	↖
8:	10,2	↘
9:	10,7*	↗
10:	10,3	↗

Serie: 96,0

Sum: 96,0

Gældende

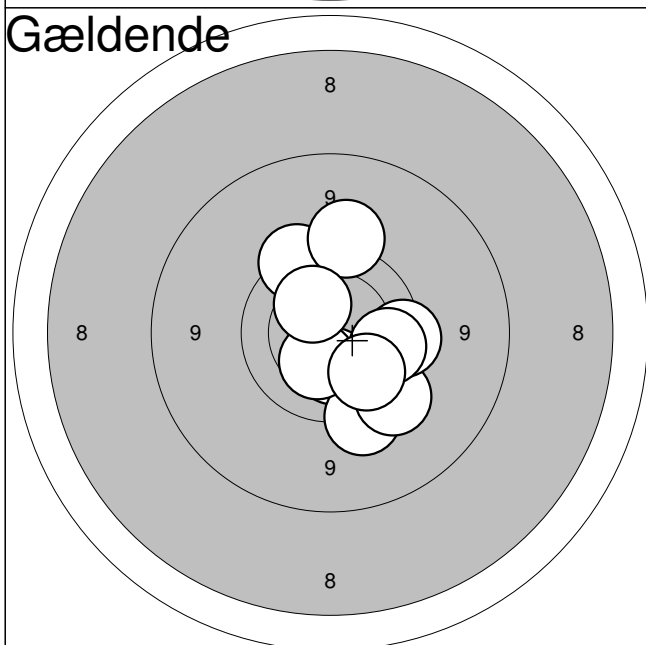

11:	10,3	↘
12:	9,7	↗
13:	9,5	↘
14:	9,5	↘
15:	10,3	↘
16:	9,7	→
17:	9,5	↗
18:	9,9	→
19:	9,9	↘
20:	10,3	↗

Serie: 93,0

Sum: 189,0

Jyllandsstævne 2011

Hold

44

Bane

11

Emili H. Sørensen

Mou &amp; Omegns Skf.

BK3

Jyllandsstævne 2011 - riffel

Aalborg Skyttekreds

Prøveskud

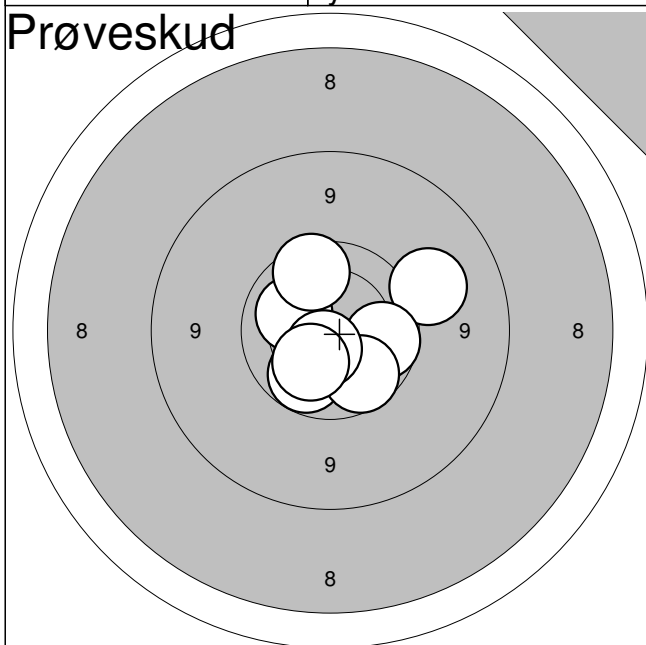

1:	10,2	↖
2:	9,3	→
3:	9,9	→
4:	9,8	↑
5:	10,0	↓
6:	9,9	↓
7:	10,6*	↓
8:	10,2	↓

Serie: 76,0

Sum: 0,0

Gældende

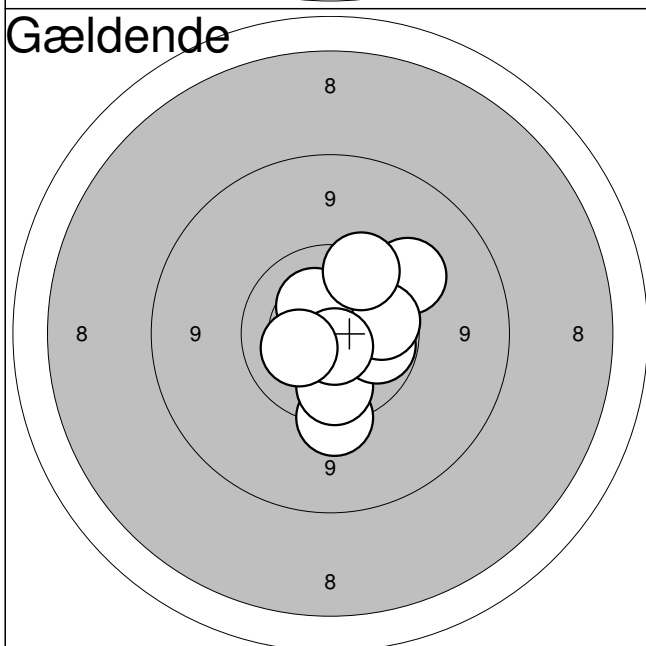

1:	10,5*	↗
2:	9,4	→
3:	9,6	↓
4:	9,9	↓
5:	10,0	→
6:	9,9	→
7:	10,3	↑
8:	10,7*	↓
9:	10,3	↖
10:	9,7	↑

Serie: 95,0

Sum: 95,0

Gældende

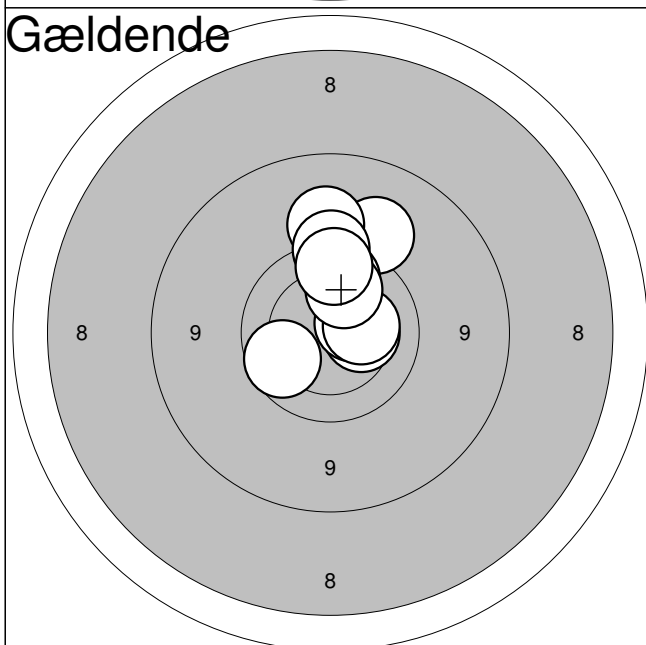

11:	9,3	↑
12:	10,3	→
13:	9,3	↑
14:	9,6	↑
15:	10,5	→
16:	9,9	↖
17:	9,9	↑
18:	10,3	→
19:	10,1	↑
20:	9,8	↑

Serie: 94,0

Sum: 189,0

Jyllandsstævne 2011

Hold  
**44**

Bane  
**12**

**Pia Kristensen**

Midtdjurs Skytteforening

3

Jyllandsstævne 2011 - riffel

Aalborg Skyttekreds

Prøveskud

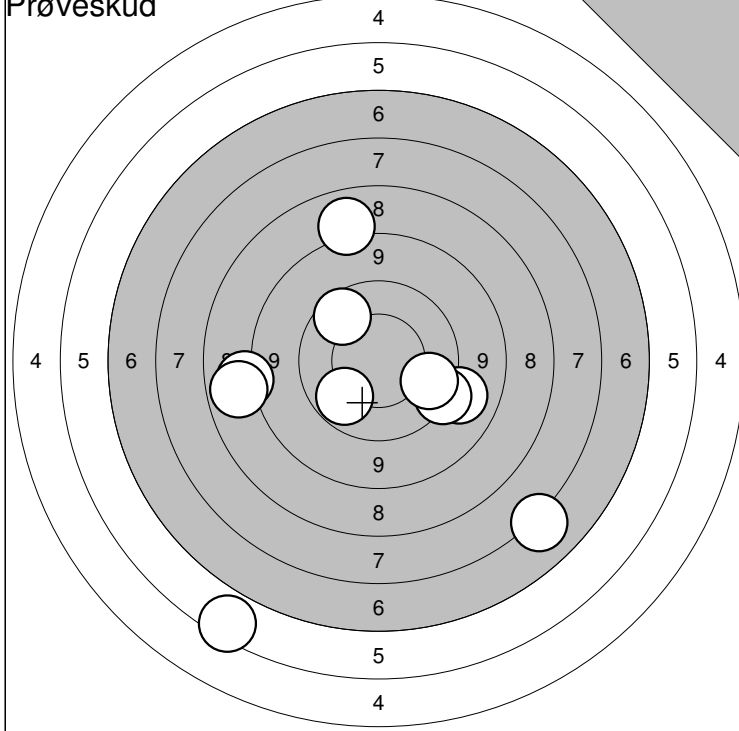

Prøveskud

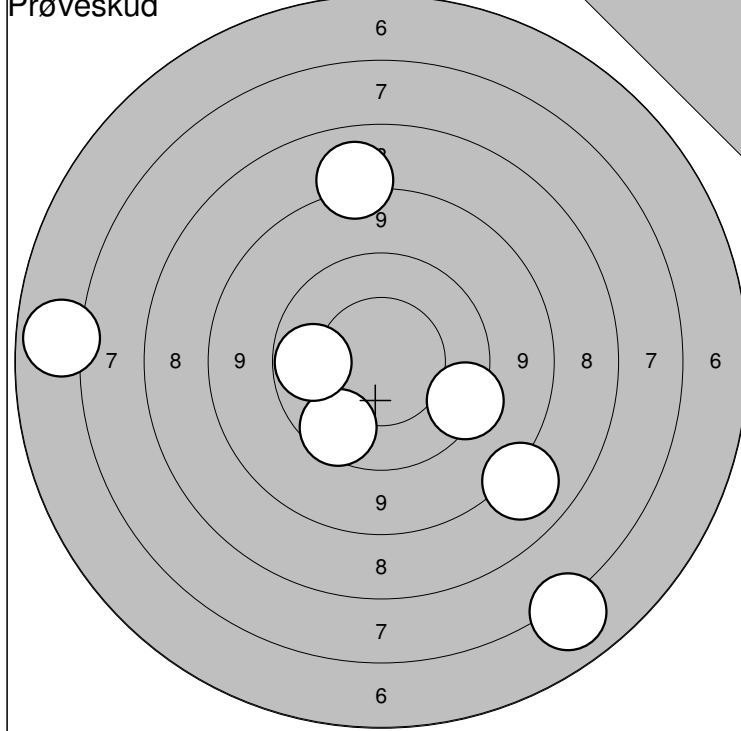

1: 6,2 ↘	6: 4,7 ↘	Serie: 80,0
2: 8,2 ↑	7: 9,9 →	
3: 10,0 ↘	8: 9,9 ↗	Sum: 0,0
4: 9,2 ↘	9: 8,2 ←	
5: 9,5 ↘	10: 8,1 ←	

11: 8,2 ↑	16: 6,1 ←	Serie: 56,0
12: 8,2 ↘	17: 10,0 ←	
13: 9,6 →		Sum: 0,0
14: 9,8 ↘		
15: 6,2 ↘		

Gældende

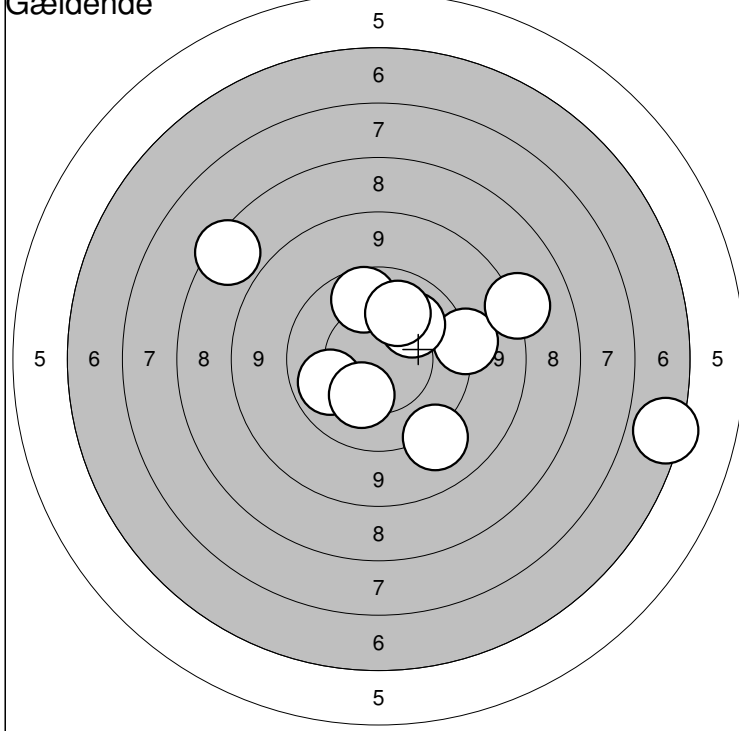

Gældende

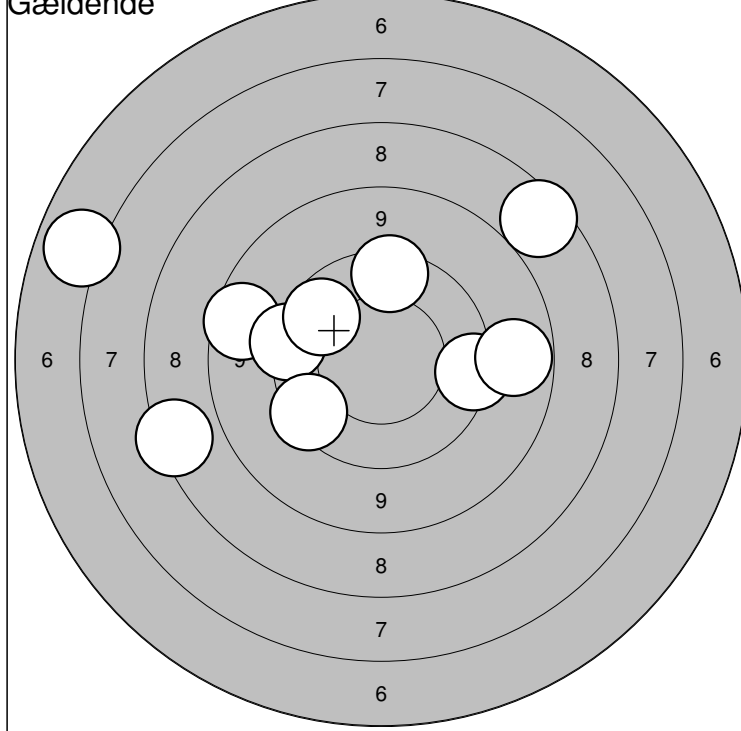

1: 10,1 ←	6: 10,1 ↗	Serie: 87,0
2: 5,6 →	7: 10,1 ↑	
3: 9,4 →	8: 8,3 →	Sum: 87,0
4: 9,9 ↑	9: 10,3 ↘	
5: 7,7 ↗	10: 9,3 ↘	

11: 8,8 ←	16: 9,7 ←	Serie: 82,0
12: 9,6 ←	17: 9,6 →	
13: 9,7 ↑	18: 9,0 →	Sum: 169,0
14: 7,6 ←	19: 6,1 ←	
15: 9,9 ↗	20: 7,8 ↗	

Jyllandsstævne 2011

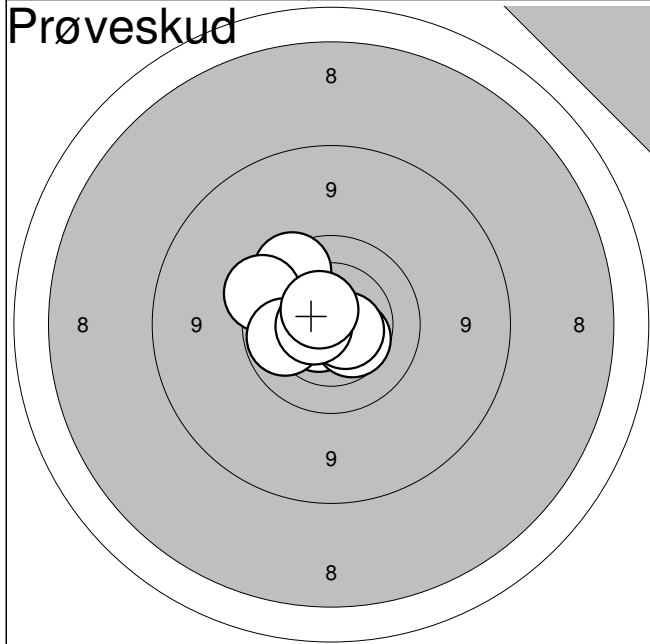

1:	10,1	↗
2:	9,8	↗
3:	9,7	↖
4:	10,7*	↙
5:	10,0	←
6:	10,4	↘
7:	10,6*	↘
8:	10,6*	←
9:	10,6*	↗

**Serie: 88,0**

**Sum: 0,0**

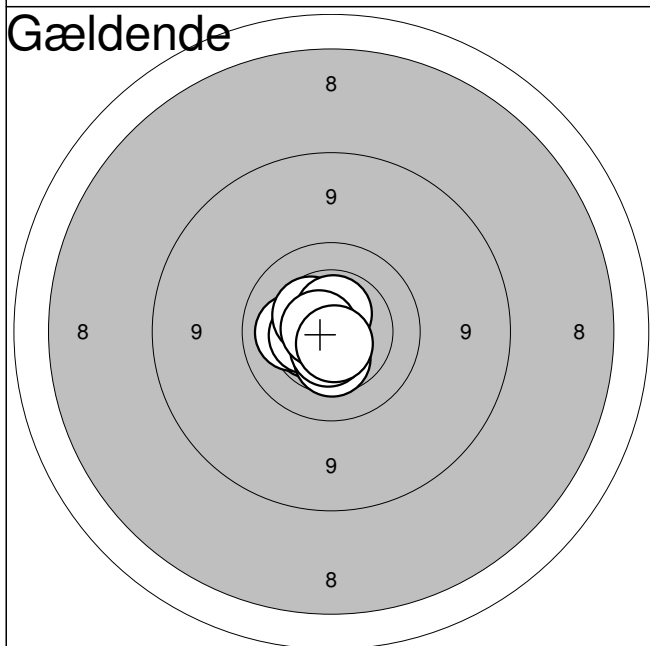

1:	10,5*	←
2:	10,7*	←
3:	10,2	←
4:	10,5	←
5:	10,4	↓
6:	10,6*	↓
7:	10,5	↗
8:	10,6*	↑
9:	10,7*	←
10:	10,7*	↓

**Serie: 100,0**

**Sum: 100,0**

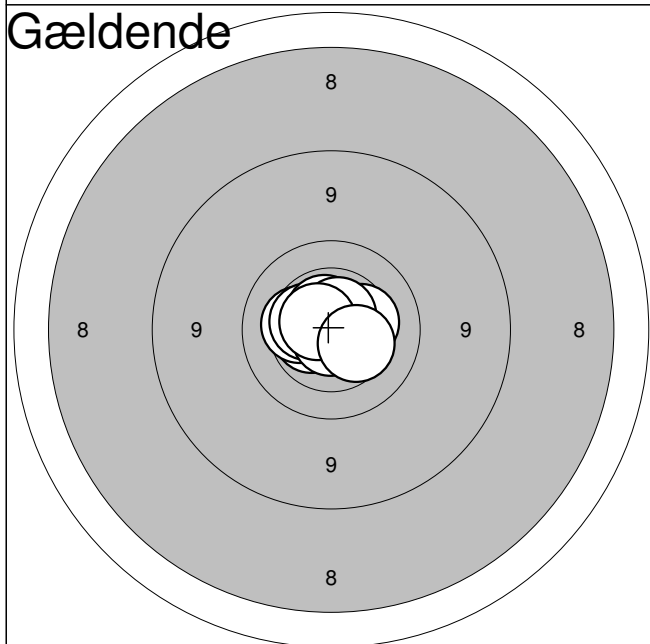

11:	10,6*	←
12:	10,3	←
13:	10,5	←
14:	10,4	→
15:	10,9*	←
16:	10,6*	↗
17:	10,6*	↗
18:	10,8*	↓
19:	10,6*	↗
20:	10,4	↘

**Serie: 100,0**

**Sum: 200,0**



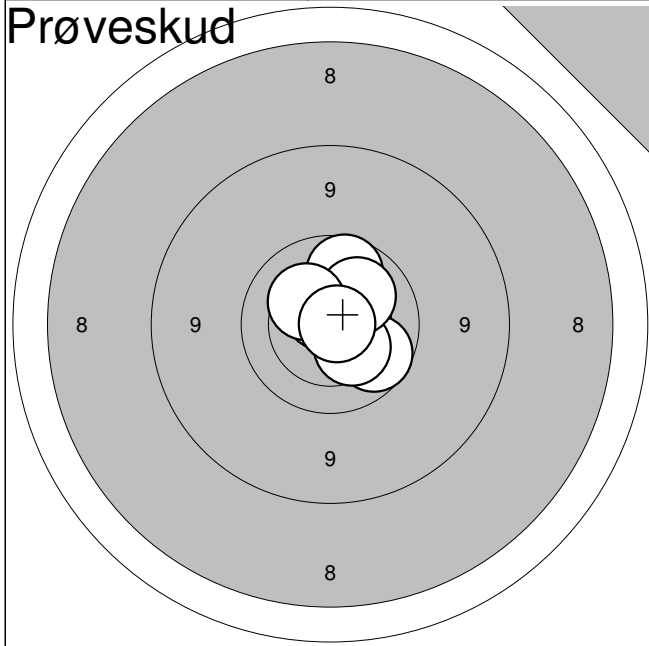

1:	9,9	↘
2:	10,5	↗
3:	9,9	↗
4:	10,7*	↗
5:	10,3	↘
6:	10,2	↗
7:	10,3	↗
8:	10,8*	→

<b>Serie:</b>	<b>78,0</b>
<b>Sum:</b>	<b>0,0</b>

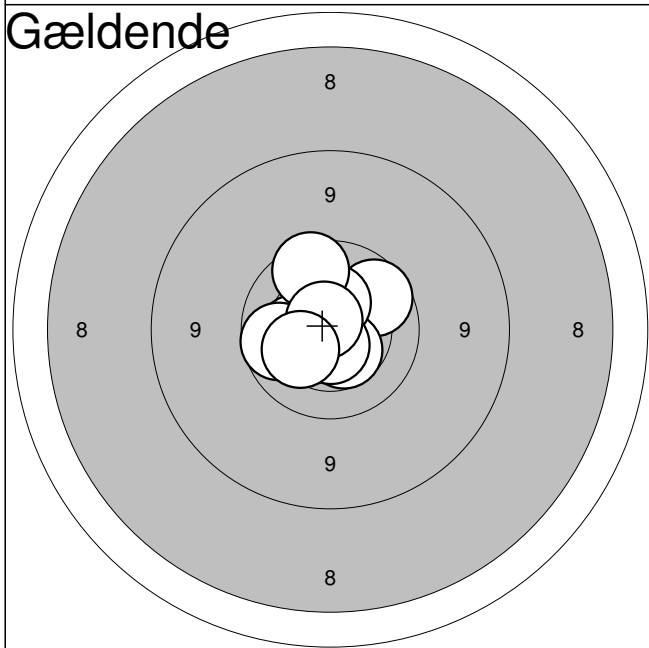

1:	9,9	↗
2:	10,5	↘
3:	10,4	↗
4:	10,3	←
5:	10,7*	↘
6:	9,9	←
7:	9,8	↗
8:	10,6*	↘
9:	10,7*	↗
10:	10,3	↘

<b>Serie:</b>	<b>97,0</b>
<b>Sum:</b>	<b>97,0</b>

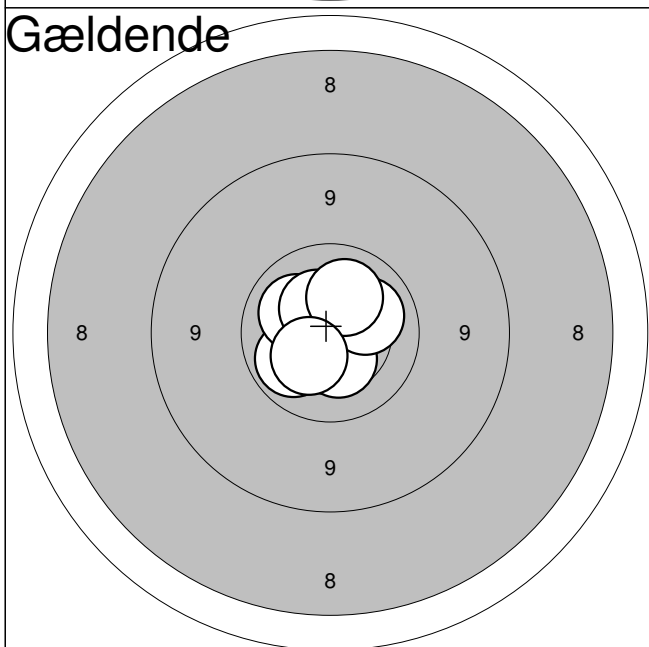

11:	10,5*	↗
12:	10,1	↘
13:	10,7*	←
14:	10,2	↗
15:	10,3	↗
16:	10,4	↗
17:	10,4	↘
18:	10,2	→
19:	10,2	↗
20:	10,3	↘

<b>Serie:</b>	<b>100,0</b>
<b>Sum:</b>	<b>197,0</b>

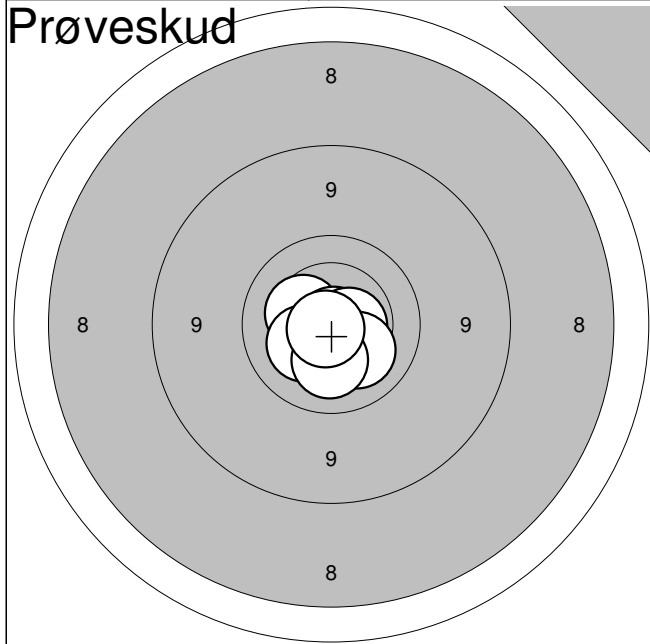

1:	10,4	↖
2:	10,4	↘
3:	10,9*	↗
4:	10,6*	→
5:	10,2	↘
6:	10,3	↖
7:	10,2	↓
8:	10,8*	↘

<b>Serie:</b>	<b>80,0</b>
<b>Sum:</b>	<b>0,0</b>

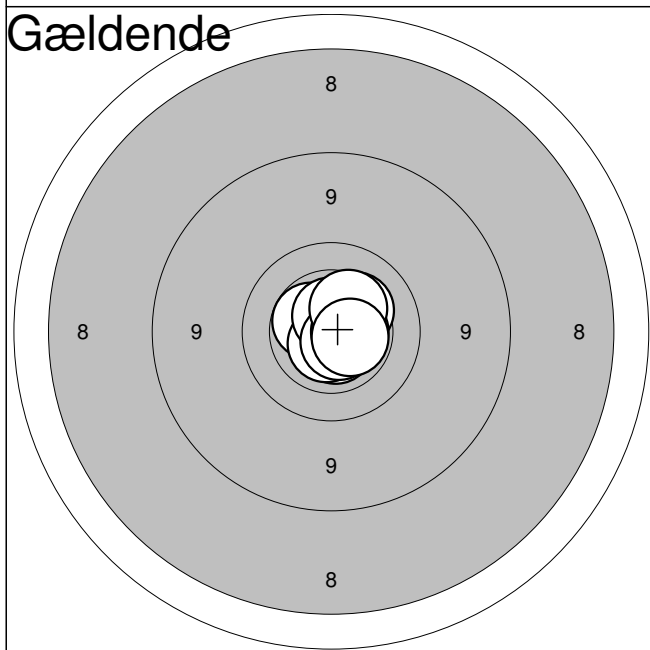

1:	10,8*	↖
2:	10,5*	↖
3:	10,7*	↘
4:	10,7*	↘
5:	10,3	↗
6:	10,7*	↑
7:	10,7*	↘
8:	10,6*	→
9:	10,4	↗
10:	10,6*	→

<b>Serie:</b>	<b>100,0</b>
<b>Sum:</b>	<b>100,0</b>

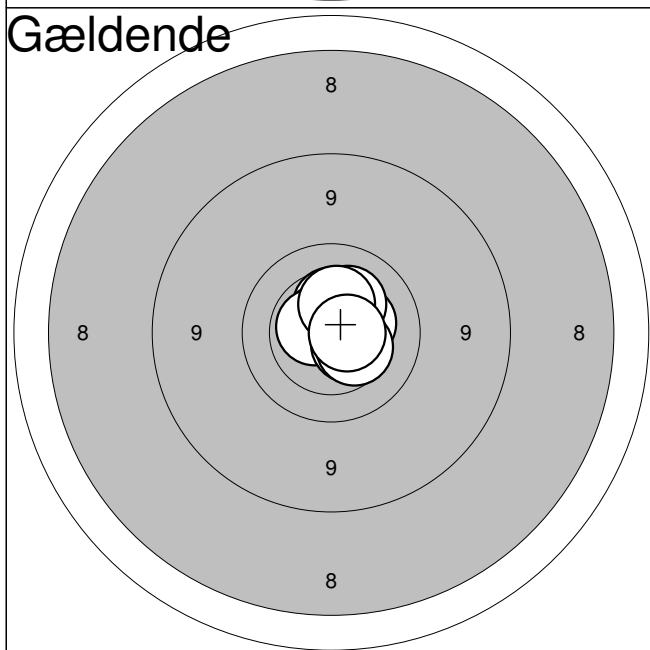

11:	10,4	↑
12:	10,7*	↗
13:	10,7*	↗
14:	10,4	→
15:	10,6*	↖
16:	10,3	↗
17:	10,5*	↘
18:	10,4	↑
19:	10,4	↘
20:	10,6*	→

<b>Serie:</b>	<b>100,0</b>
<b>Sum:</b>	<b>200,0</b>

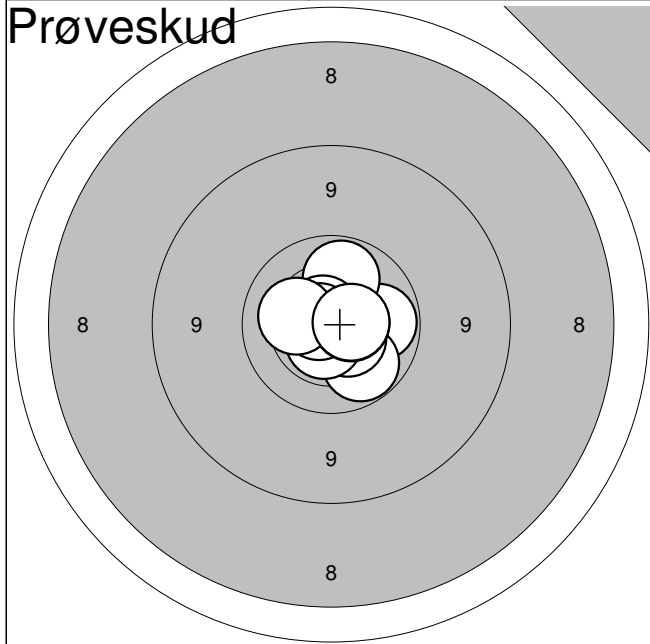

1:	10,0	→
2:	10,0	↓
3:	10,0	↑
4:	10,5*	↓
5:	10,6*	↓
6:	10,7*	↗
7:	10,7*	←
8:	10,6*	→
9:	10,3	←
10:	10,6*	→

**Serie:** 100,0

**Sum:** 0,0

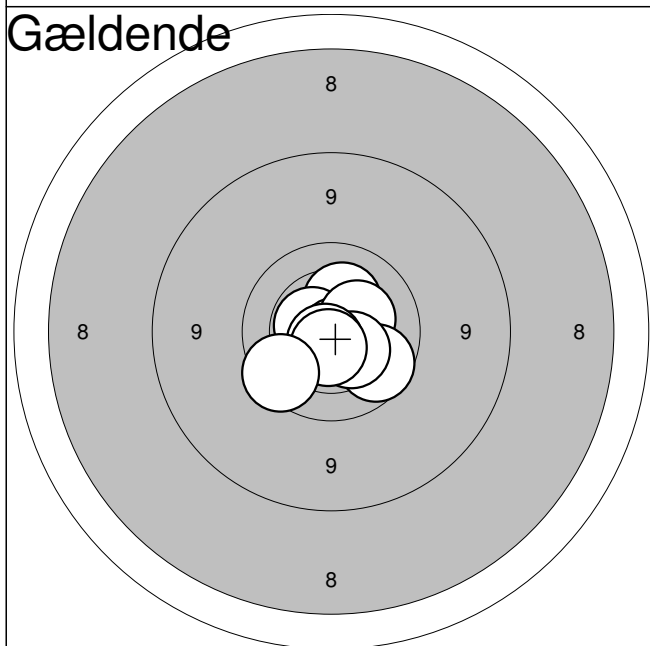

1:	10,7*	→
2:	10,3	↑
3:	10,6*	←
4:	10,8*	↓
5:	10,4	↗
6:	9,9	↓
7:	10,4	↓
8:	10,7*	↓
9:	10,6*	↓
10:	9,8	↙

**Serie:** 98,0

**Sum:** 98,0

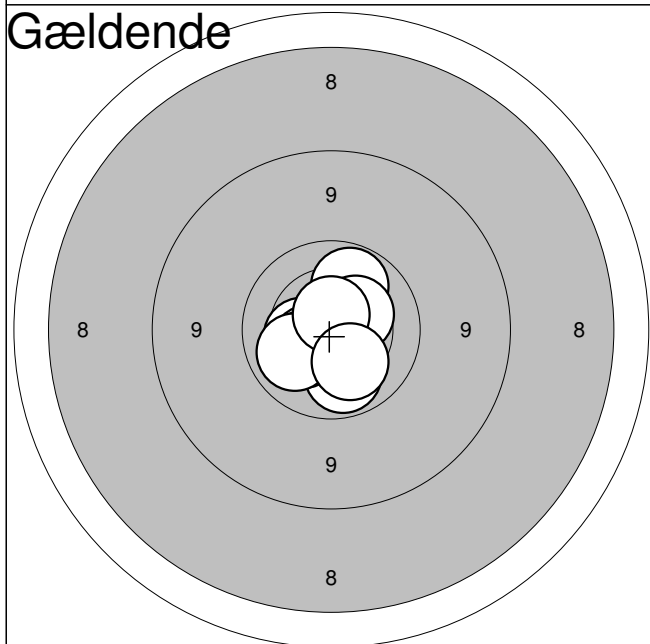

11:	10,4	←
12:	10,0	↓
13:	10,0	↗
14:	10,4	←
15:	10,3	←
16:	10,7*	→
17:	10,1	←
18:	10,4	↗
19:	10,7*	↑
20:	10,2	↓

**Serie:** 100,0

**Sum:** 198,0

Hold

45

Bane

6

Jarl Linde

Vilsted Skf.

3

Jyllandsstævne 2011 - riffel

Aalborg Skyttekreds

Prøveskud

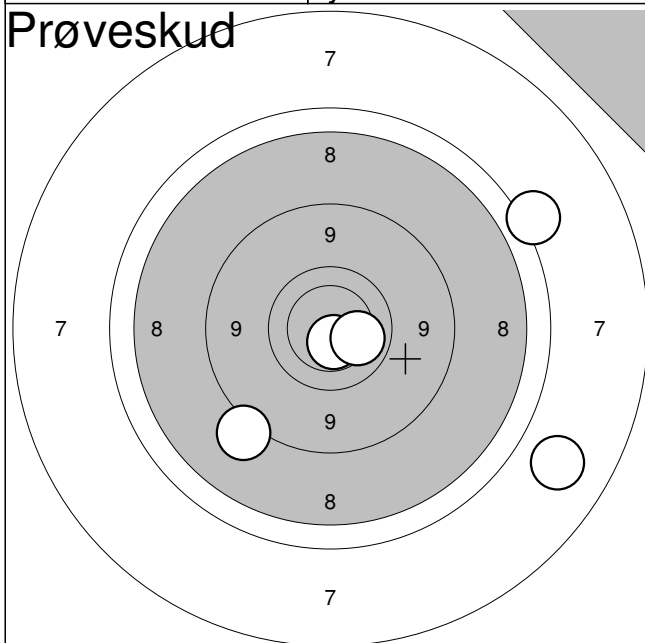

1: 8,6

↘

2: 10,5\*

↘

3: 7,6

↗

4: 7,2

↘

5: 10,1

↘

Serie: 42,0

Sum: 0,0

Gældende

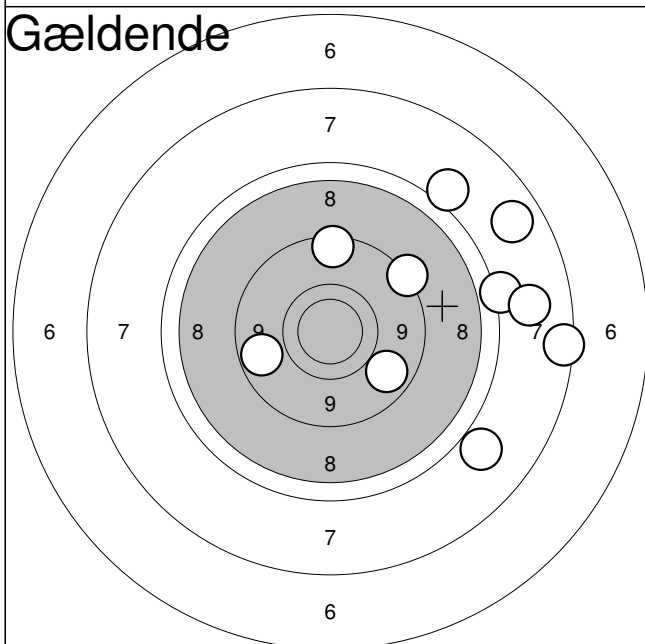

1: 7,6

→

2: 8,7

↗

3: 9,0

←

4: 9,1

↘

5: 6,8

→

6: 7,4

↘

7: 8,8

↑

8: 7,1

↗

9: 7,5

↗

10: 7,2

→

Serie: 75,0

Sum: 75,0

Gældende

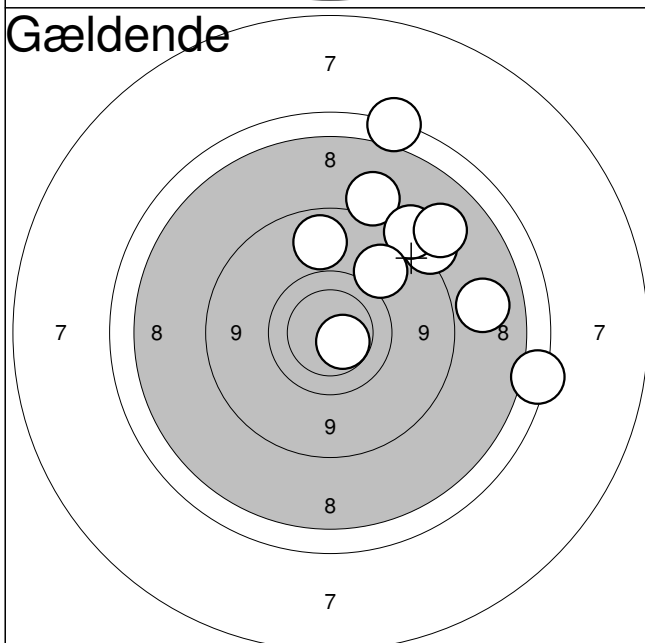

11: 8,4

→

12: 8,6

↗

13: 7,8

→

14: 8,5

↑

15: 8,6

↗

16: 9,2

↗

17: 8,4

↗

18: 9,1

↑

19: 10,5\*

↘

20: 7,7

↑

Serie: 82,0

Sum: 157,0

Jyllandsstævne 2011

Hold  
**45**Bane  
**7****Philip Kristensen**

Midtdjurs Skytteforening

BK1

Jyllandsstævne 2011 - riffel

Aalborg Skyttekreds

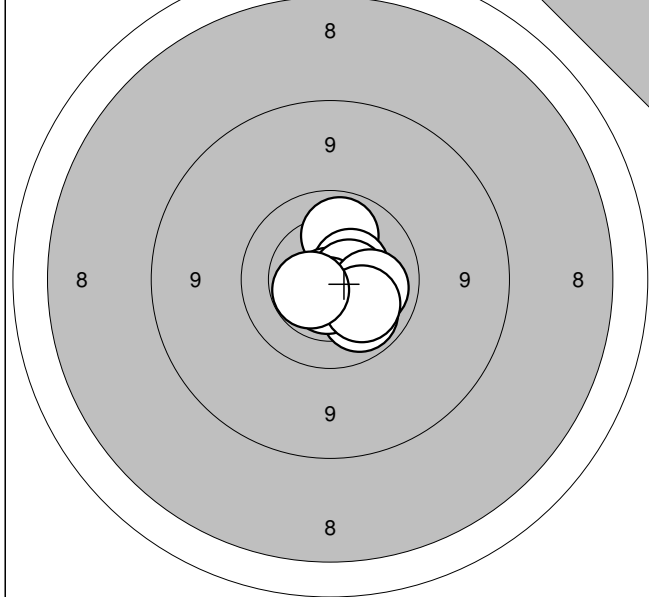
**Prøveskud**

1:	10,1	↑
2:	10,5	→
3:	10,1	↓
4:	10,8*	↓
5:	10,6*	→
6:	10,6*	↓
7:	10,1	→
8:	10,2	↓
9:	10,5*	↙

Serie: 90,0

Sum: 0,0

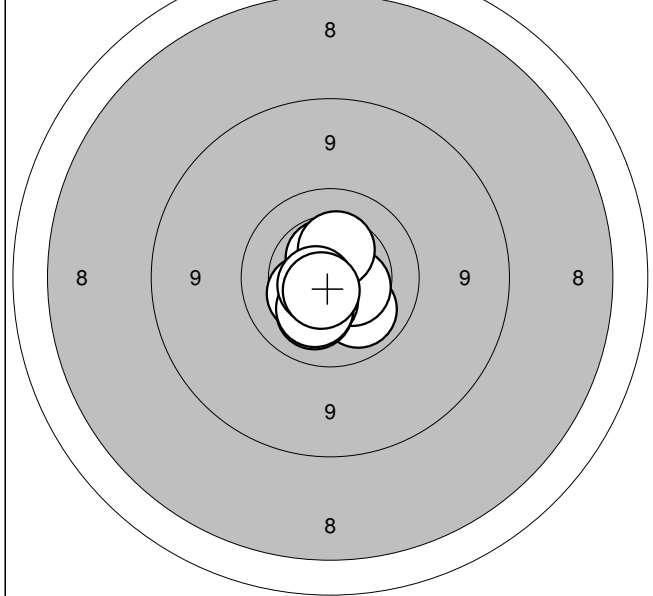
**Gældende**

1:	10,1	↓
2:	10,5	→
3:	10,6*	↑
4:	10,2	↓
5:	10,4	↑
6:	10,4	←
7:	10,4	↓
8:	10,3	↓
9:	10,6*	←
10:	10,6*	↓

Serie: 100,0

Sum: 100,0

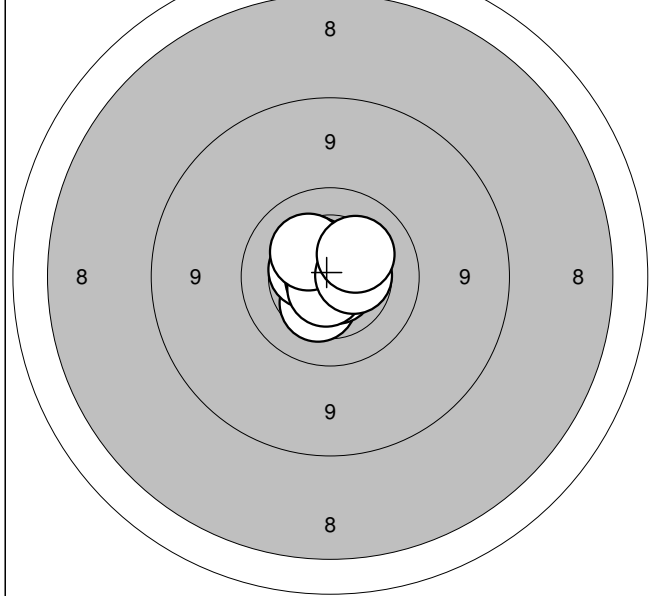
**Gældende**

11:	10,4	↓
12:	10,5*	↑
13:	10,7*	↓
14:	10,5	←
15:	10,8*	←
16:	10,4	↑
17:	10,7*	↓
18:	10,3	↑
19:	10,5	→
20:	10,3	↗

Serie: 100,0

Sum: 200,0

Jyllandsstævne 2011

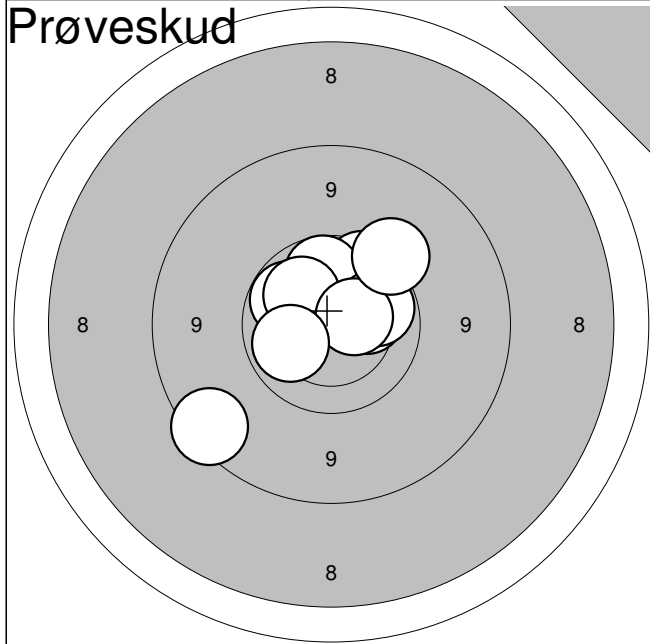

1:	9,8	↗
2:	10,0	↑
3:	10,0	↖
4:	10,1	↗
5:	10,2	→
6:	10,0	→
7:	8,8	↙
8:	10,5	→
9:	9,5	↗
10:	10,1	↙

<b>Serie:</b>	<b>96,0</b>
---------------	-------------

<b>Sum:</b>	<b>0,0</b>
-------------	------------

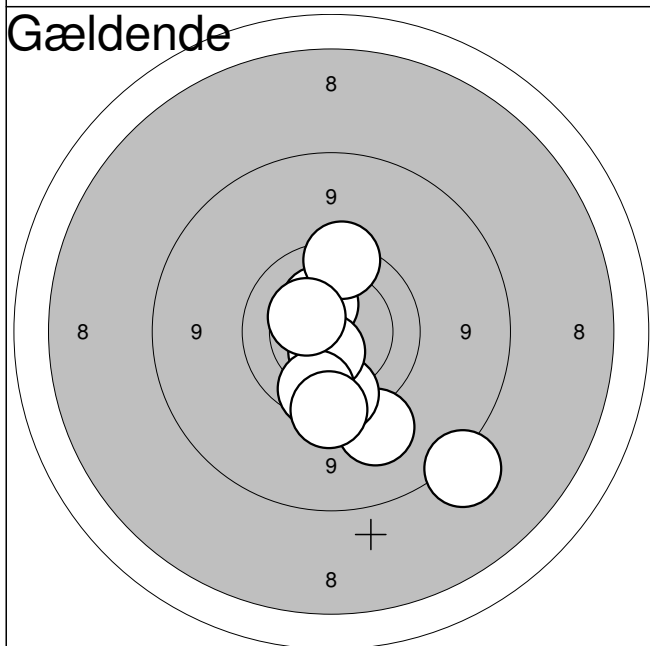

1:	10,4	↗
2:	9,3	↘
3:	9,8	↘
4:	9,7	↑
5:	8,6	↘
6:	10,5*	↘
7:	9,9	↘
8:	0,0	↘
9:	9,6	↘
10:	10,4	↗

<b>Serie:</b>	<b>83,0</b>
---------------	-------------

<b>Sum:</b>	<b>83,0</b>
-------------	-------------

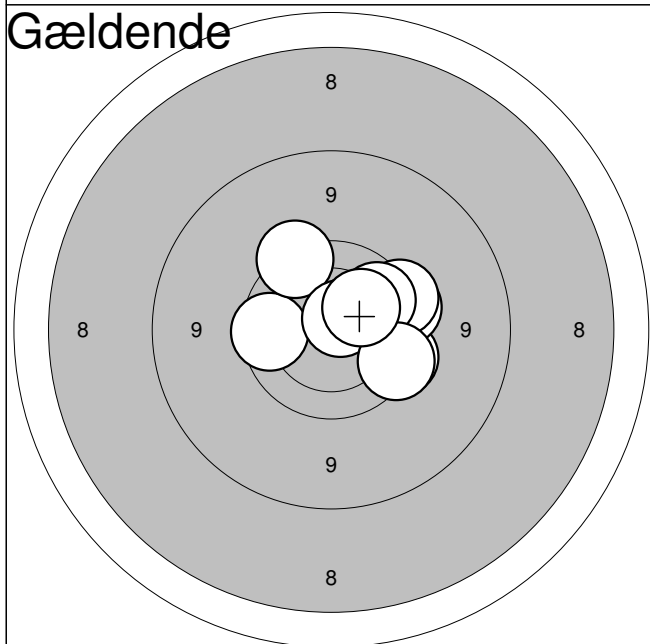

11:	9,7	↘
12:	9,8	←
13:	9,7	→
14:	9,6	↑
15:	9,7	→
16:	9,9	↗
17:	10,5	↗
18:	10,7*	↗
19:	9,7	↘
20:	10,2	↗

<b>Serie:</b>	<b>93,0</b>
---------------	-------------

<b>Sum:</b>	<b>176,0</b>
-------------	--------------

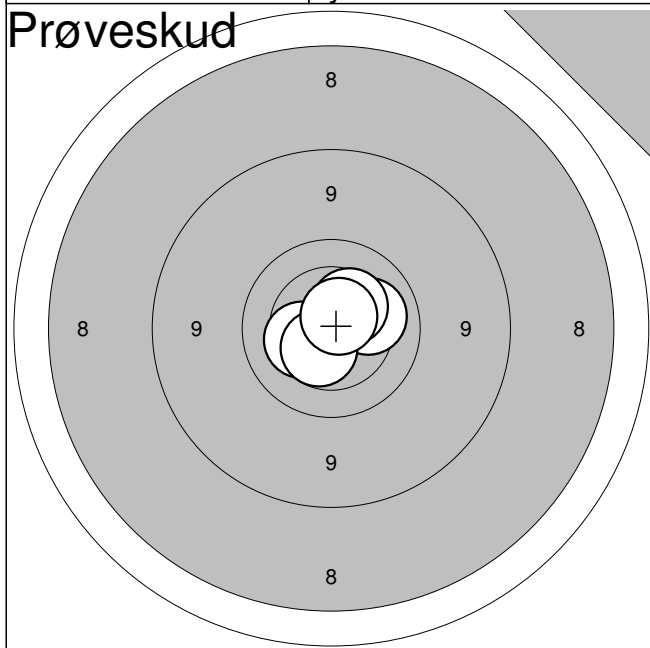

1:	10,4	←
2:	10,2	→
3:	10,5*	↙
4:	10,4	↗
5:	10,7*	↗

Serie:	50,0
Sum:	0,0

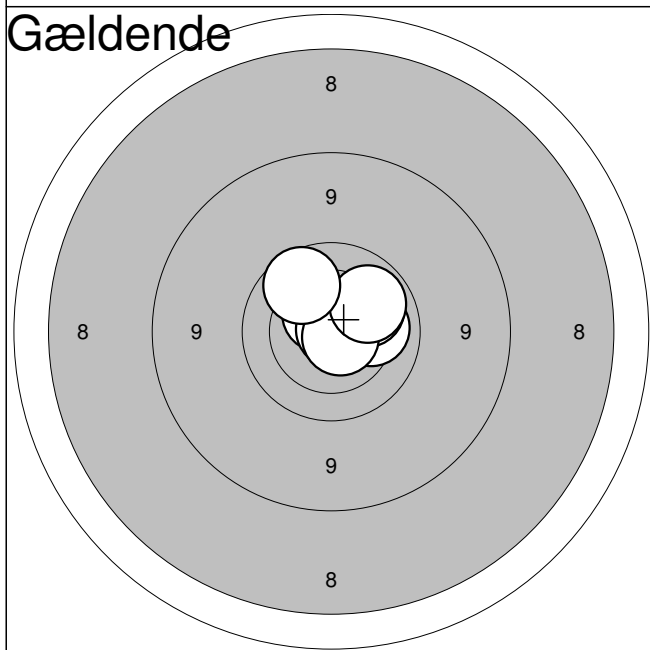

1:	10,8*	→
2:	10,4	↗
3:	10,8*	→
4:	10,5*	↗
5:	10,2	→
6:	10,9*	→
7:	10,1	↗
8:	10,7*	↘
9:	10,1	↗
10:	9,9	↗

Serie:	99,0
Sum:	99,0

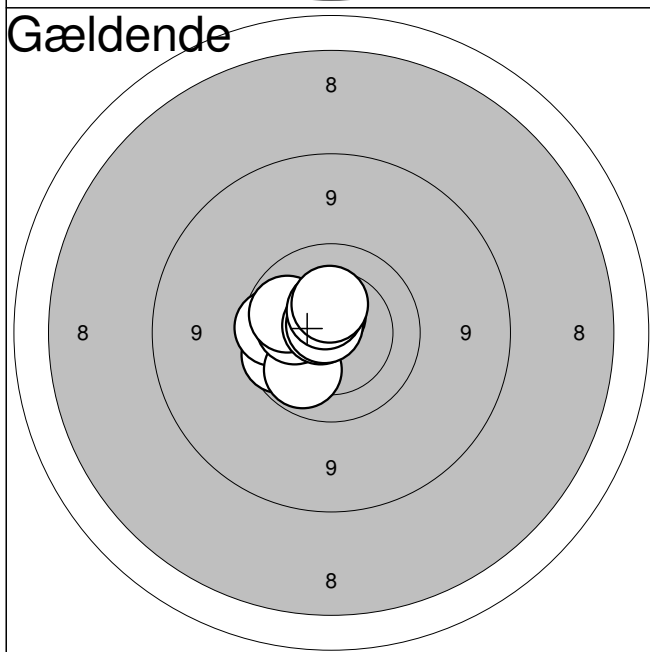

11:	9,9	←
12:	9,9	←
13:	10,6*	↑
14:	10,0	↘
15:	10,2	←
16:	10,0	←
17:	10,7*	↗
18:	10,8*	↗
19:	10,5*	↑
20:	10,4	↑

Serie:	98,0
Sum:	197,0

Hold  
**45**Bane  
**10****Asbjørn Risgård Nielsen**

Vilsted Skf.

BK1

Jyllandsstævne 2011 - riffel

Aalborg Skyttekreds

Prøveskud

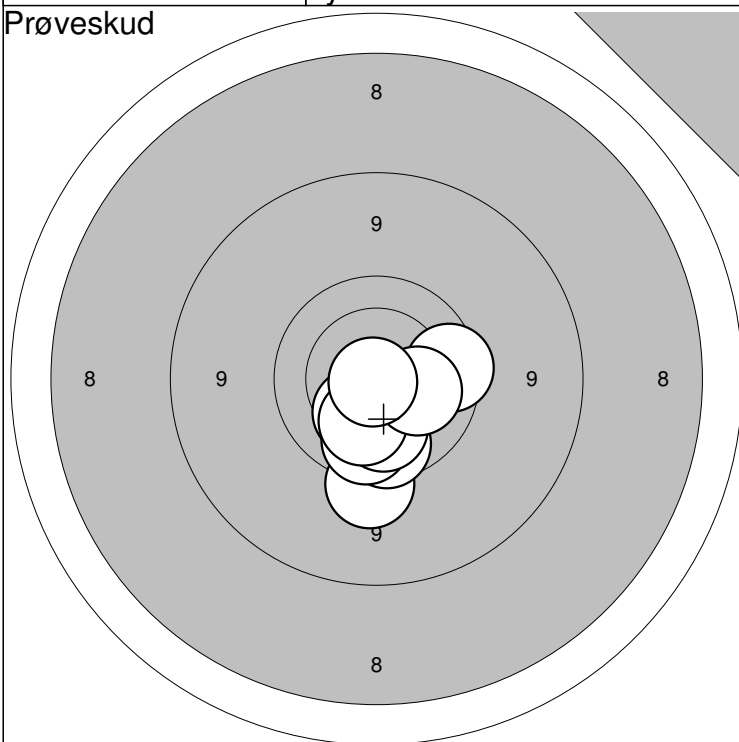

Prøveskud

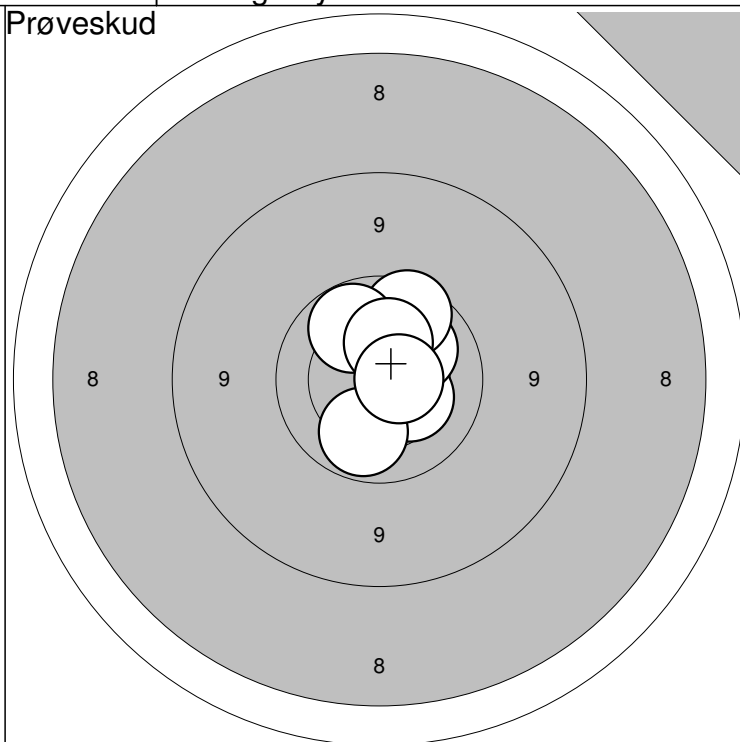

1: 9,5

↓

6:10,3

↓

Serie: 96,0

2: 9,8

→

7:10,1

↓

11:10,3

↘

16:10,3

↑

Serie: 69,0

3:10,3

↙

8:10,2

↓

12:10,2

↗

17:10,6\*

→

4: 9,9

↓

9:10,2

→

Sum: 0,0

13: 9,8

↑

Sum: 0,0

5: 9,9

↓

10:10,9\*

↙

14:10,0

↓

15:10,0

↗

Gældende

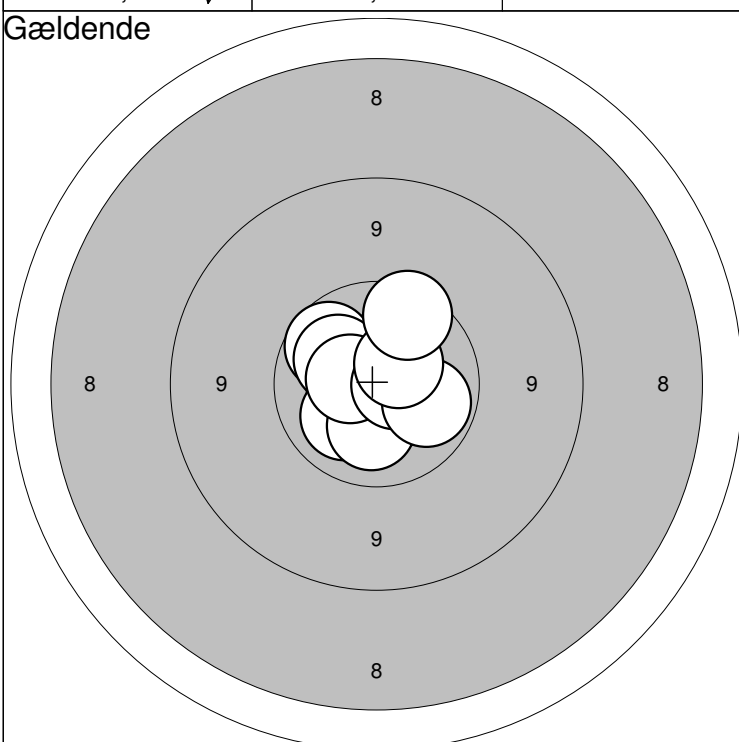

Gældende

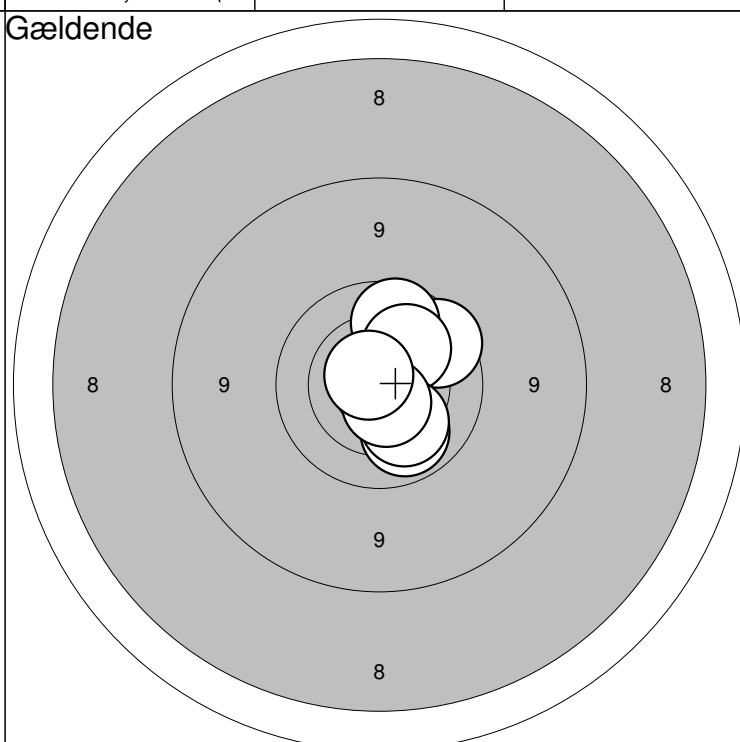

1:10,3

↙

6:10,5\*

←

Serie: 98,0

2:10,2

↙

7:10,6\*

→

11: 9,8

↗

16:10,0

↓

Serie: 98,0

3:10,2

↓

8:10,0

→

12:10,3

↓

17:10,2

↗

4: 9,9

↖

9:10,4

↗

Sum: 98,0

13: 9,9

↑

18:10,2

↓

Sum: 196,0

5:10,2

↖

10: 9,8

↑

14:10,7\*

↖

19:10,6\*

↓

15:10,9\*

↙

20:10,7\*

↗

Jyllandsstævne 2011



Hold  
**45**

Bane  
**11**

# Jonas Engberg Hansen

Vilsted Skf.

BK2

Jyllandsstævne 2011 - riffel

Aalborg Skyttekreds

Prøveskud

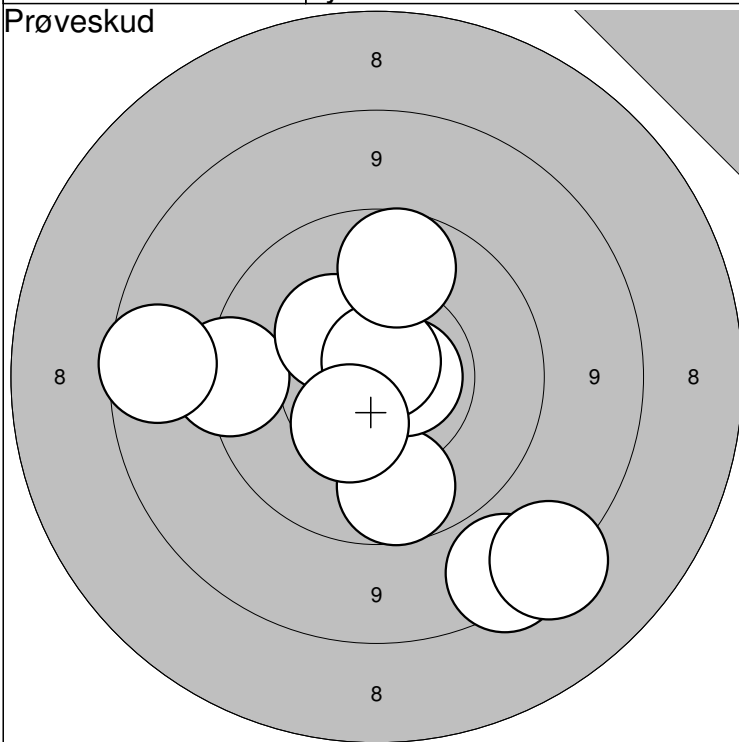

Prøveskud

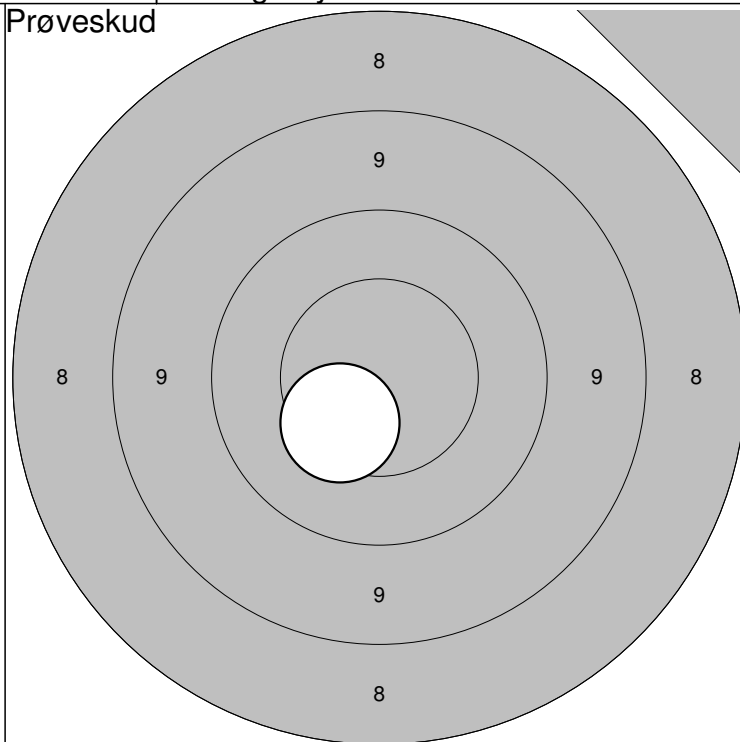

1: 9,9 ↓  
 2: 8,7 ↓  
 3: 8,5 ↓  
 4: 9,6 ←  
 5: 8,8 ←

6:10,7\* →  
 7:10,4 ↗  
 8:10,8\* ↑  
 9: 9,9 ↑  
 10:10,5 ↓

Serie: 91,0

Sum: 0,0

11:10,4 ↙

Serie: 10,0

Sum: 0,0

Gældende

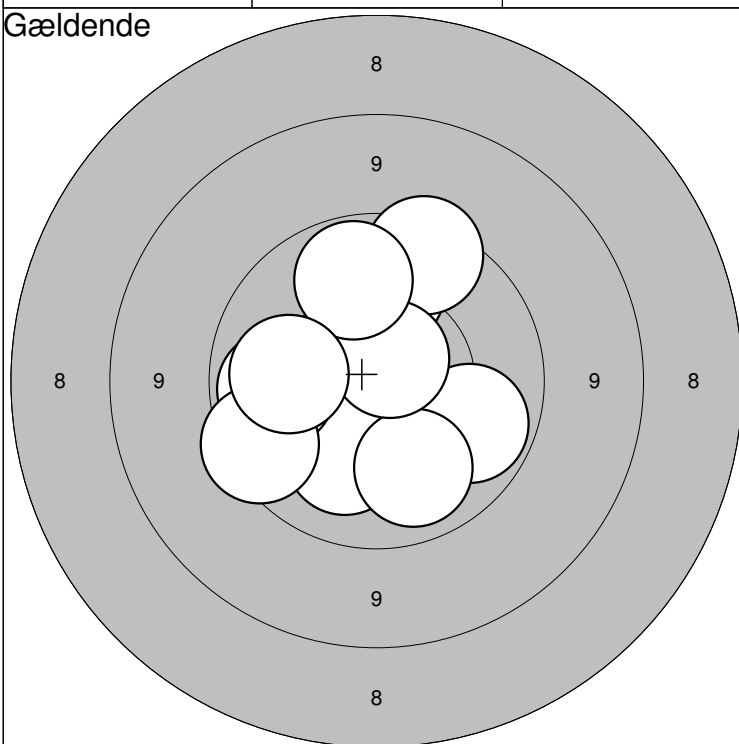

Gældende

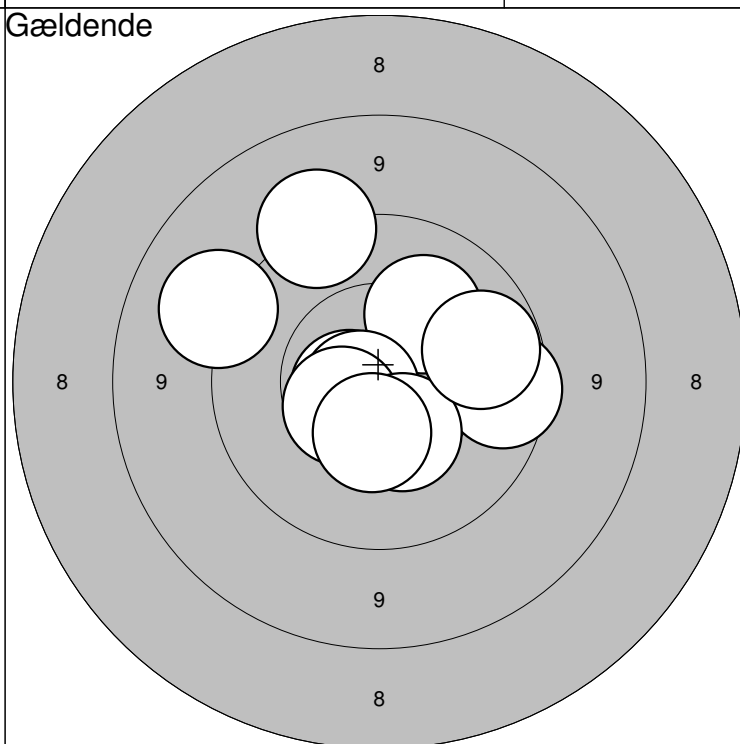

1:10,1 ↑  
 2:10,2 ↓  
 3:10,0 →  
 4:10,1 ↓  
 5:10,0 ←

6: 9,7 ↑  
 7:10,7\* ↗  
 8: 9,7 ←  
 9:10,0 ↑  
 10:10,1 ←

Serie: 98,0

Sum: 98,0

11: 9,4 ↑  
 12: 9,3 ←  
 13:10,2 ↗  
 14:10,7\* ←  
 15:10,8\* ←

16:10,5 ←  
 17: 9,8 →  
 18:10,4 ↓  
 19:10,0 →  
 20:10,5 ↓

Serie: 97,0

Sum: 195,0

Jyllandsstævne 2011

Hold  
**45**Bane  
**12****Marcus Hovkjær**

Vilsted Skf.

BK3

Jyllandsstævne 2011 - riffel

Aalborg Skyttekreds

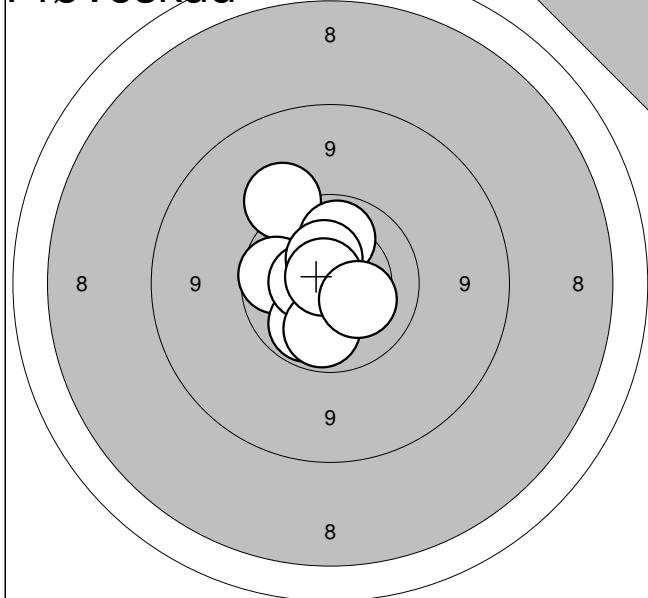
**Prøveskud**

1: 9,5  
 2: 9,9  
 3: 10,1  
 4: 10,0  
 5: 10,5\*  
 6: 10,5  
 7: 10,0  
 8: 10,8\*  
 9: 10,3

↗  
 ←  
 ↑  
 ↓  
 ←  
 ↑  
 ↓  
 ↗  
 ↘

Serie: 88,0

Sum: 0,0

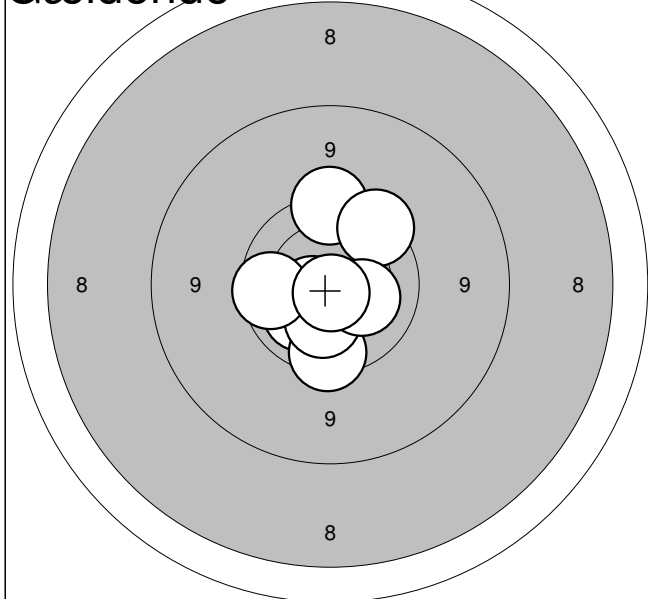
**Gældende**

1: 9,6  
 2: 10,2  
 3: 10,2  
 4: 10,6\*  
 5: 9,8  
 6: 10,3  
 7: 9,9  
 8: 9,7  
 9: 10,3  
 10: 10,8\*

↑  
 ↓  
 ↘  
 ↘  
 ↓  
 ↓  
 ←  
 ↗  
 →  
 ↓

Serie: 96,0

Sum: 96,0

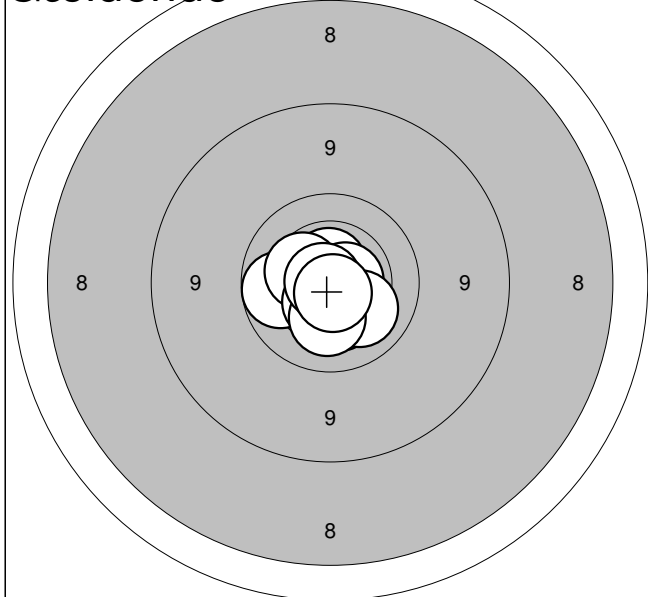
**Gældende**

11: 10,6\*  
 12: 10,0  
 13: 10,3  
 14: 10,6\*  
 15: 10,4  
 16: 10,2  
 17: 10,5\*  
 18: 10,3  
 19: 10,8\*  
 20: 10,7\*

↑  
 ←  
 ↓  
 →  
 ↗  
 ↓  
 ↓  
 ↓  
 ←  
 ↓

Serie: 100,0

Sum: 196,0

Jyllandsstævne 2011

Hold  
**46**

Bane  
**1**

# Casper Kunuunnguaq Kreutzmann

Ulsted Skf.

BK3

Jyllandsstævne 2011 - riffel

Aalborg Skyttekreds

## Prøveskud

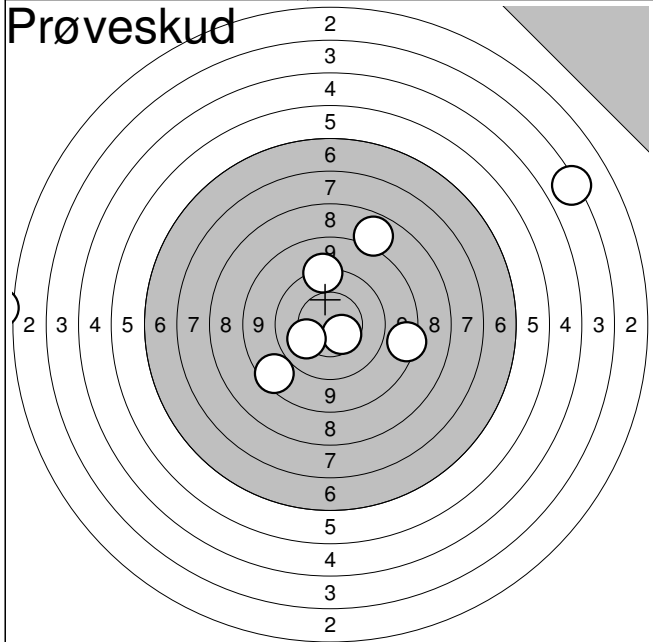

1:	8,0	↗
2:	8,8	↖
3:	10,5	↘
4:	9,5	↗
5:	2,5	↗
6:	10,2	↖
7:	0,0	↖
8:	8,7	↗

**Serie: 55,0**

**Sum: 0,0**

## Gældende

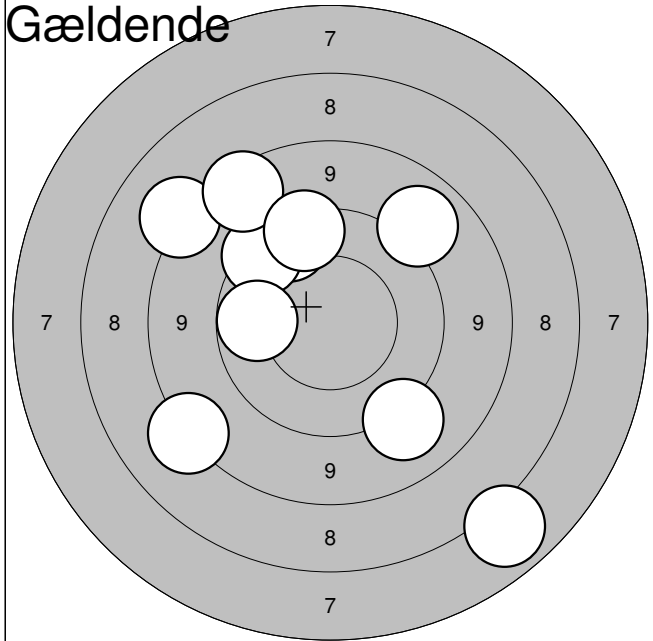

1:	8,4	↖
2:	9,7	↗
3:	8,3	↗
4:	9,6	↗
5:	8,7	↗
6:	7,1	↘
7:	9,2	↘
8:	10,0	↖
9:	9,1	↗
10:	9,6	↗

**Serie: 86,0**

**Sum: 86,0**

## Gældende

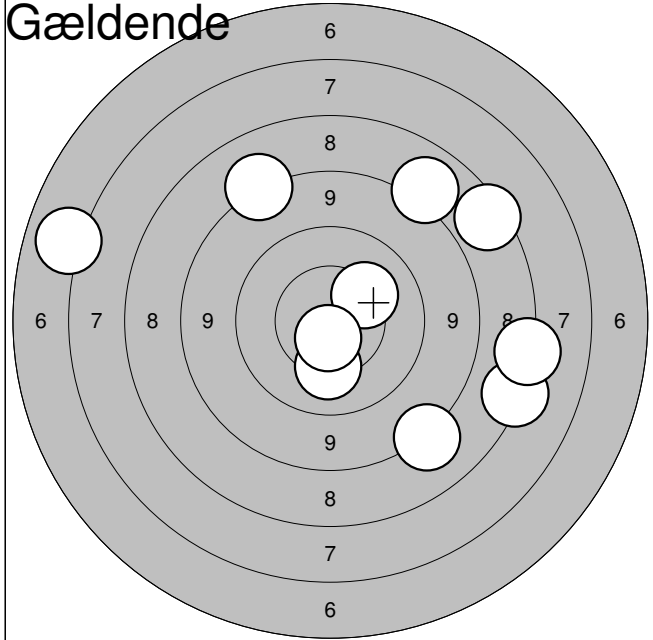

11:	10,2	↘
12:	7,5	↘
13:	8,3	↘
14:	6,1	↖
15:	8,1	↗
16:	7,7	↗
17:	10,2	↗
18:	10,7*	↘
19:	8,3	↗
20:	7,5	↗

**Serie: 81,0**

**Sum: 167,0**

Jyllandsstævne 2011

Hold  
**46**Bane  
**2****Michael Brasch**

Midtdjurs Skytteforening

ÅK1

Jyllandsstævne 2011 - riffel

Aalborg Skyttekreds

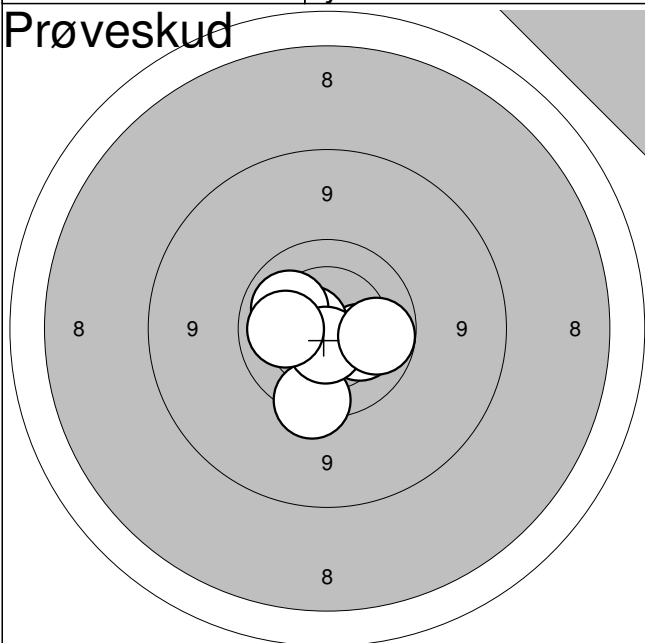
**Prøveskud**

1:	10,2	↘
2:	10,6*	↙
3:	10,1	↗
4:	9,7	↓
5:	10,6*	↓
6:	10,1	↙
7:	10,0	→

Serie: 69,0

Sum: 0,0

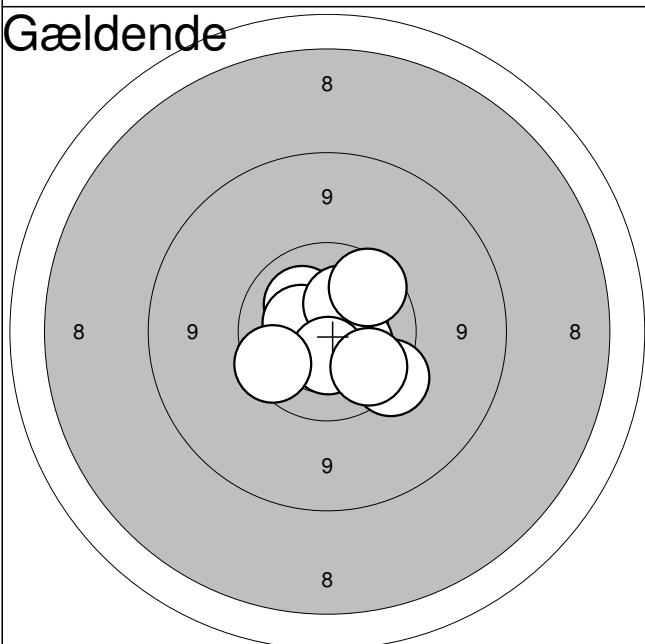
**Gældende**

1:	10,2	↗
2:	10,4	→
3:	10,4	↙
4:	10,4	↙
5:	10,3	↗
6:	10,5	↓
7:	9,9	↗
8:	9,8	↙
9:	9,6	↘
10:	9,9	↘

Serie: 96,0

Sum: 96,0

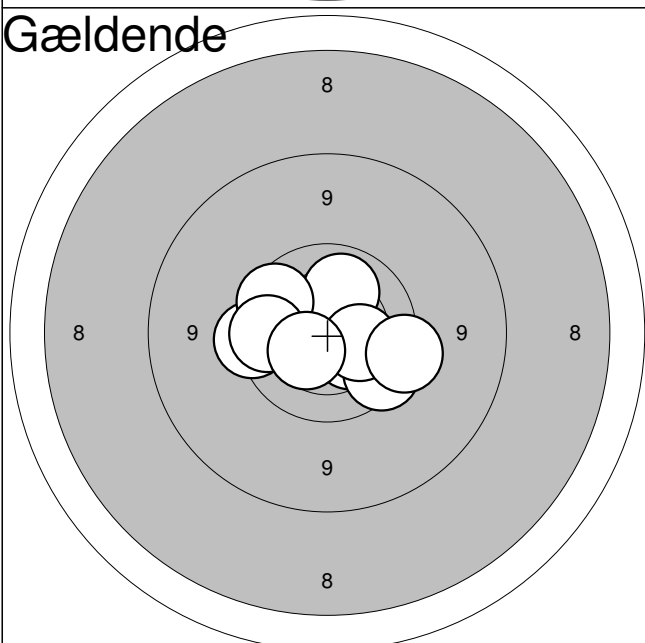
**Gældende**

11:	9,7	↙
12:	10,7*	↑
13:	10,4	↘
14:	10,1	↗
15:	9,8	↘
16:	10,3	→
17:	9,8	↗
18:	9,9	↙
19:	10,4	↘
20:	9,6	→

Serie: 95,0

Sum: 191,0

Jyllandsstævne 2011

Hold  
**46**

Bane  
**3**

# Kasper Nørgaard Hansen

Aalborg Skyttekreds

UNG

Jyllandsstævne 2011 - riffel

Aalborg Skyttekreds

Prøveskud

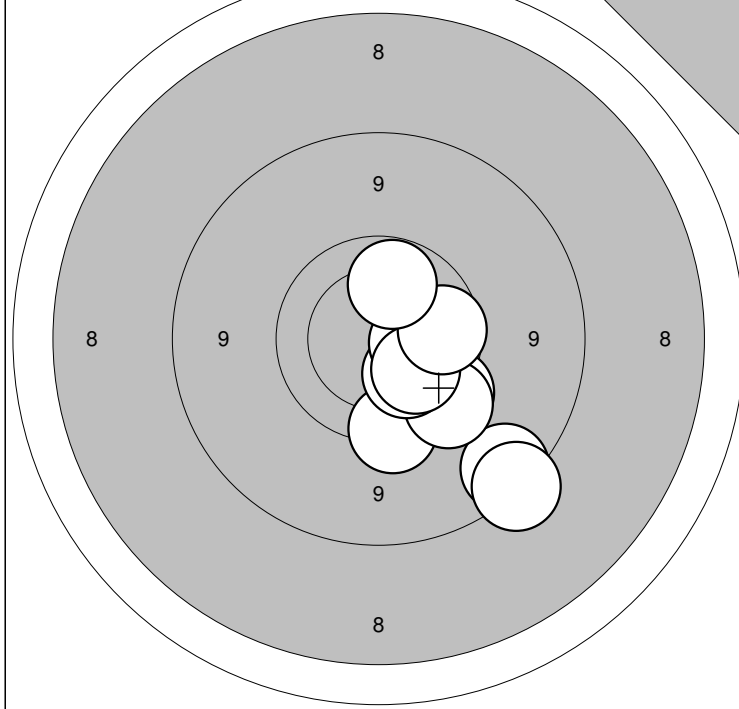

Prøveskud

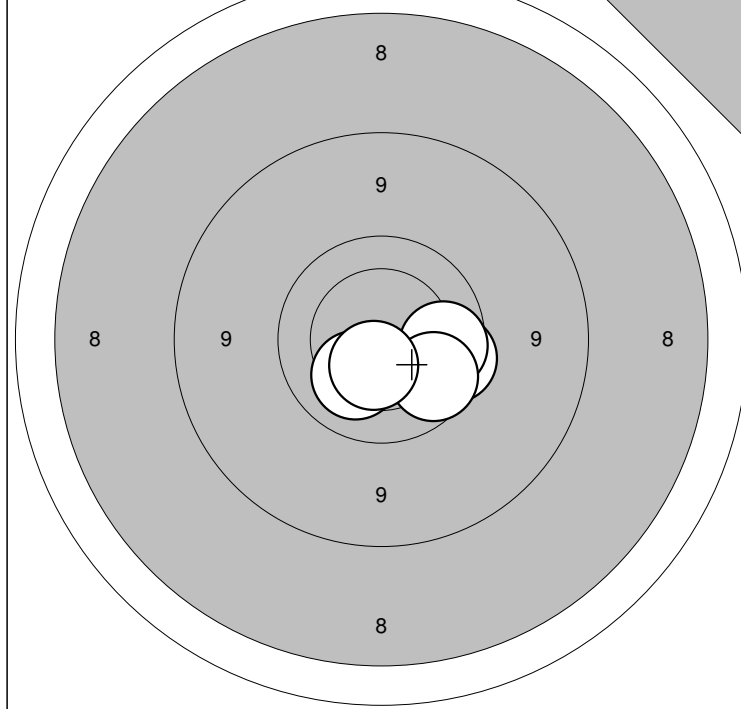

1: 9,7	↘	6:10,3	→
2: 8,8	↘	7:10,1	↘
3: 9,6	↘	8: 9,9	→
4: 9,6	↘	9:10,0	↑
5:10,2	↘	10: 8,7	↘

Serie:	92,0
Sum:	0,0

11: 9,8	→
12: 9,9	→
13:10,2	↘
14: 9,9	↘
15:10,5	↘

Serie:	47,0
Sum:	0,0

Gældende

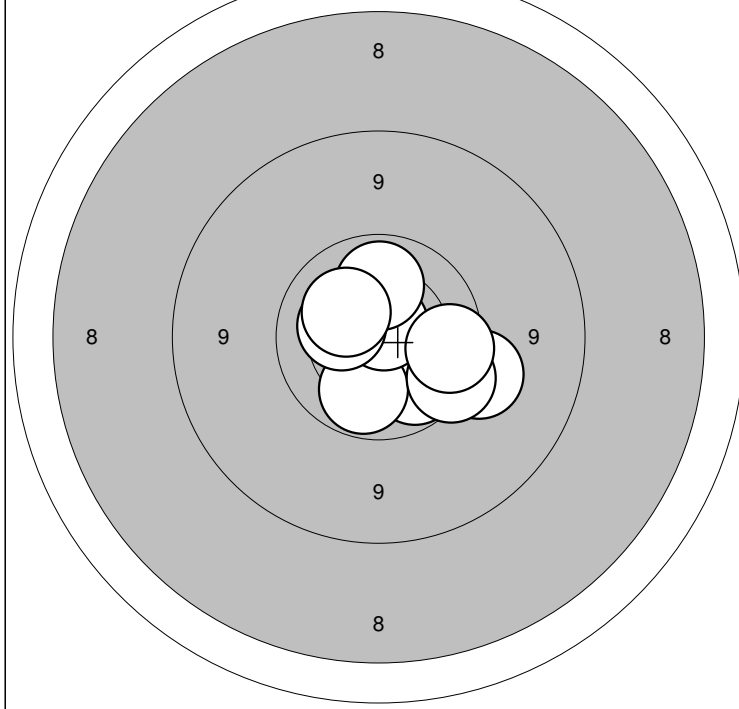

Gældende

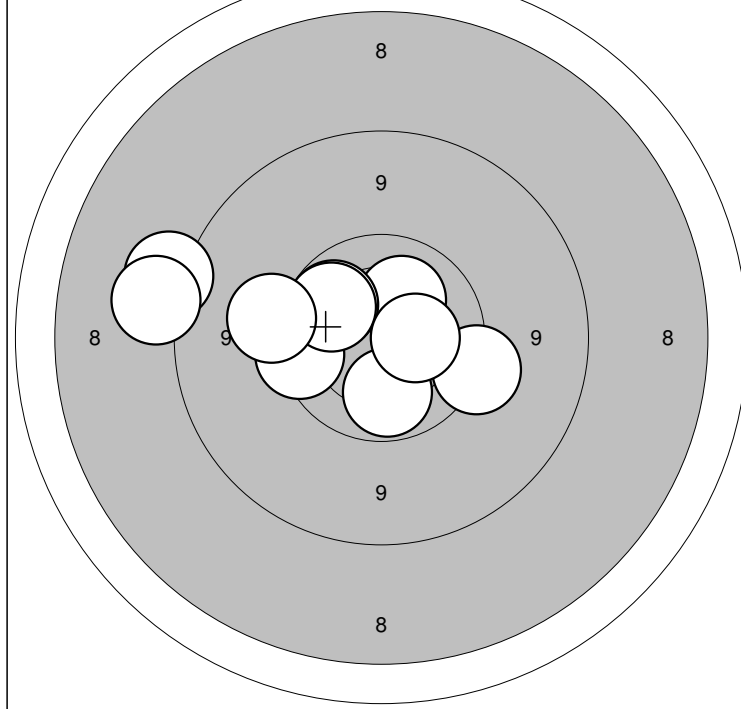

1: 9,5	↘	6:10,7*	↑
2:10,0	↘	7:10,1	↑
3:10,4	↗	8: 9,8	→
4:10,0	↘	9:10,3	←
5: 9,7	↘	10:10,3	↗

Serie:	97,0
Sum:	97,0

11: 9,5	→	16: 8,6	←
12:10,2	↗	17:10,0	↖
13:10,0	↖	18:10,4	→
14:10,0	↘	19: 9,5	←
15: 9,7	←	20: 8,5	←

Serie:	93,0
Sum:	190,0

Hold  
**46**Bane  
**4****Thomas Martinsen**

Midtdjurs Skytteforening

ÅK3

Jyllandsstævne 2011 - riffel

Aalborg Skyttekreds

Prøveskud

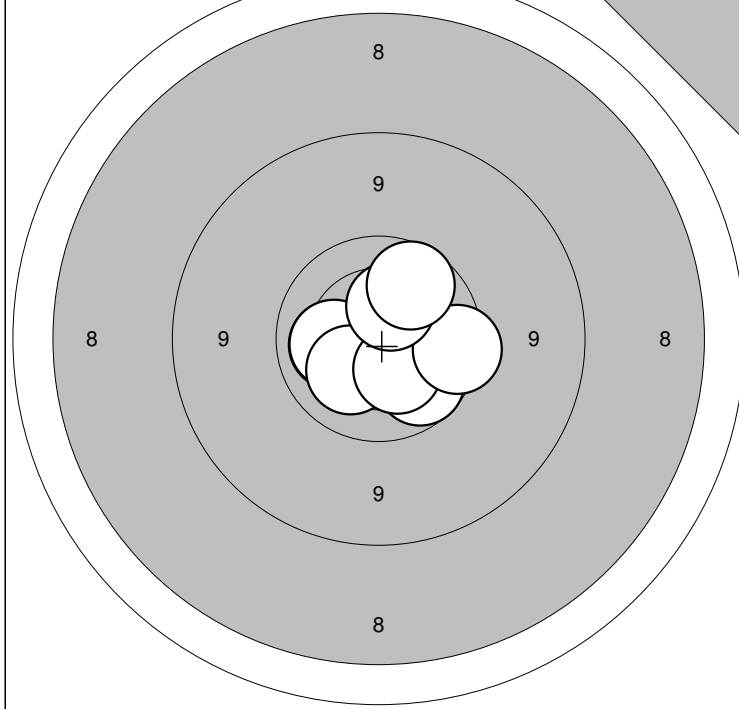

Prøveskud

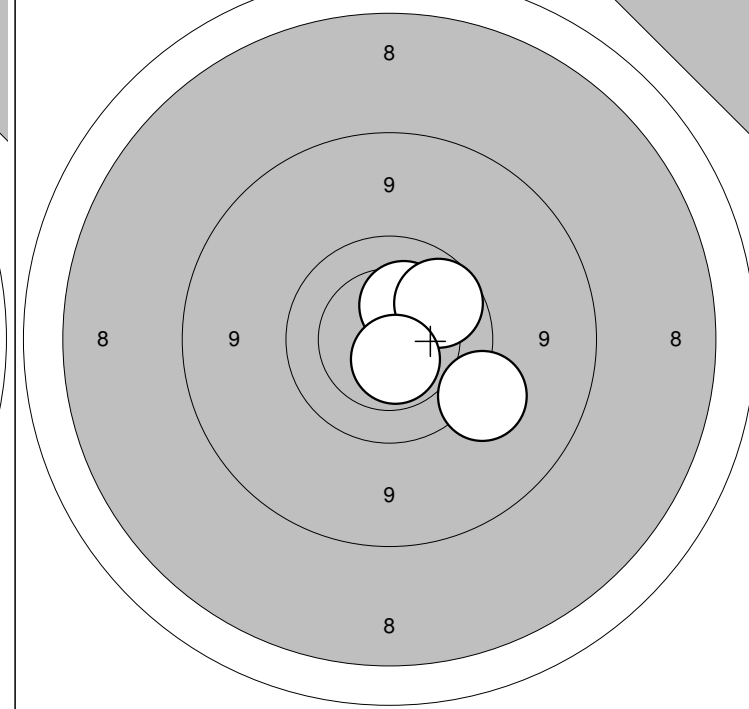

1: 9,9 ↘  
2: 10,4 ↙  
3: 10,2 ←  
4: 10,6\* ↙  
5: 10,2 ←

6: 10,2 ↙  
7: 10,3 ↘  
8: 9,7 →  
9: 10,4 ↗  
10: 9,9 ↗

Serie: 97,0  
Sum: 0,0

11: 10,3 ↗  
12: 9,5 ↘  
13: 9,9 ↗  
14: 10,6\* ↘

Serie: 38,0  
Sum: 0,0

Gældende

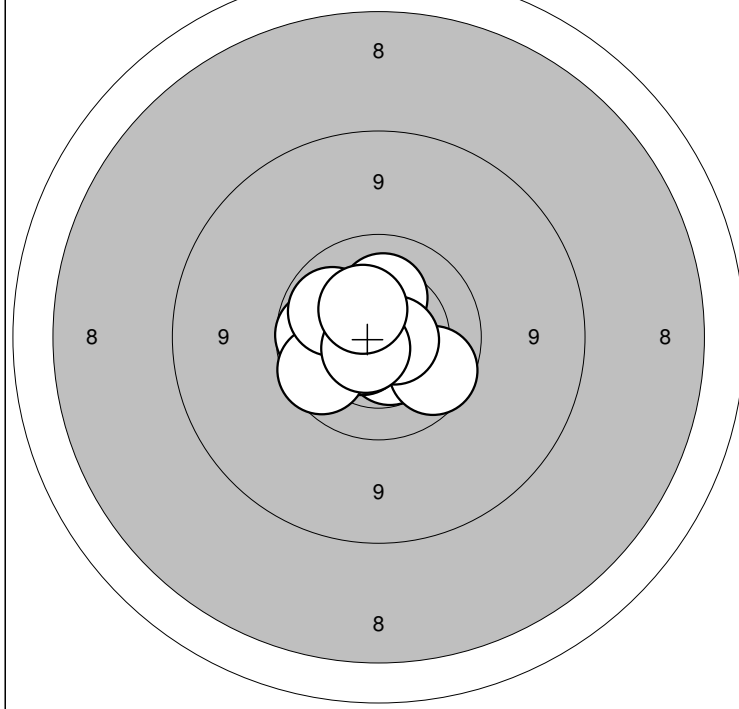

Gældende

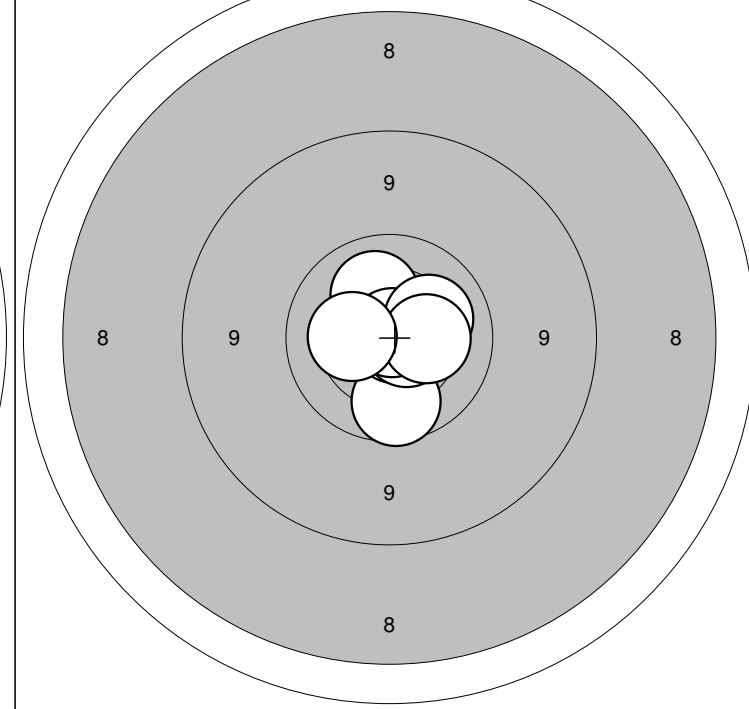

1: 10,5\* ↘  
2: 10,0 ←  
3: 10,6\* ↙  
4: 9,9 ↙  
5: 9,9 ↘

6: 10,1 ↖  
7: 10,3 ↗  
8: 10,7\* →  
9: 10,7\* ↙  
10: 10,4 ↗

Serie: 98,0  
Sum: 98,0

11: 10,7\* ↗  
12: 10,8\* ↘  
13: 9,9 ↘  
14: 10,8\* →  
15: 10,2 ↗

16: 10,6\* →  
17: 10,9\* ↗  
18: 10,2 →  
19: 10,3 →  
20: 10,3 ←

Serie: 99,0  
Sum: 197,0

Jyllandsstævne 2011

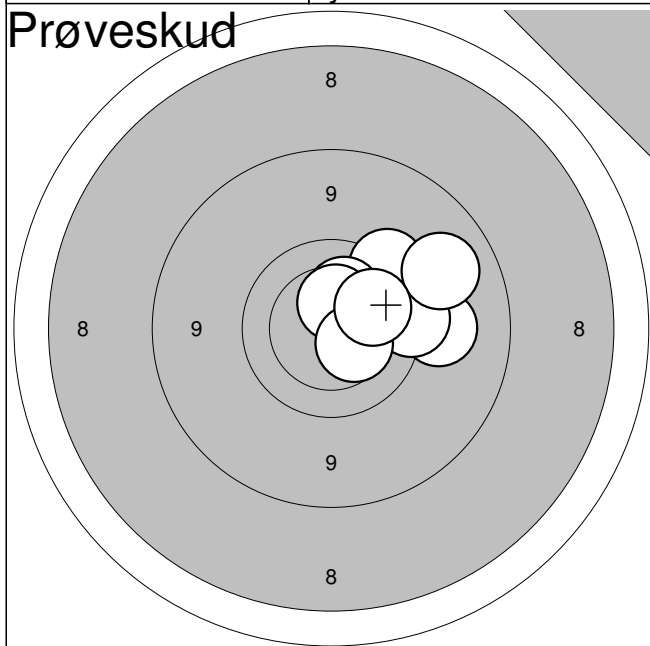

1:	9,6	↗
2:	10,3	↑
3:	10,4	↑
4:	9,3	→
5:	9,6	→
6:	9,1	↗
7:	10,4	↘
8:	10,0	→

**Serie: 76,0**

**Sum: 0,0**

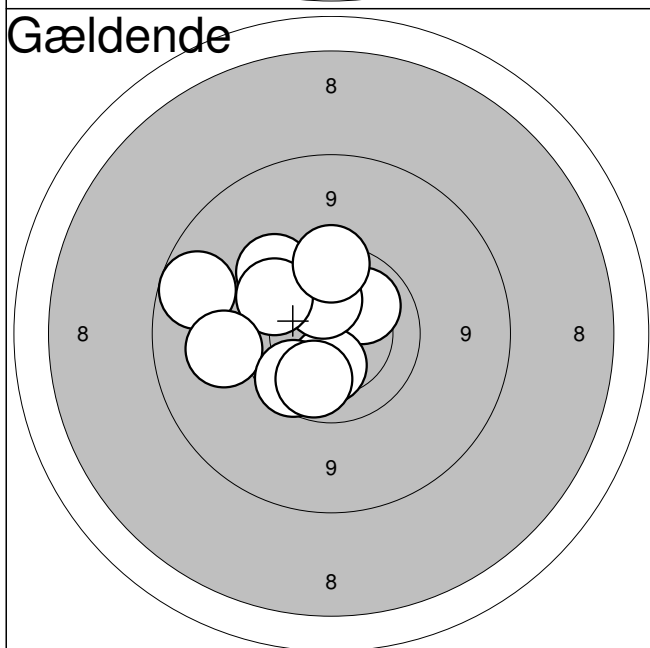

1:	10,1	↗
2:	9,6	↗
3:	10,3	↓
4:	10,3	↑
5:	9,8	↗
6:	9,0	←
7:	9,7	↑
8:	9,3	←
9:	9,9	↘
10:	10,0	↓

**Serie: 94,0**

**Sum: 94,0**

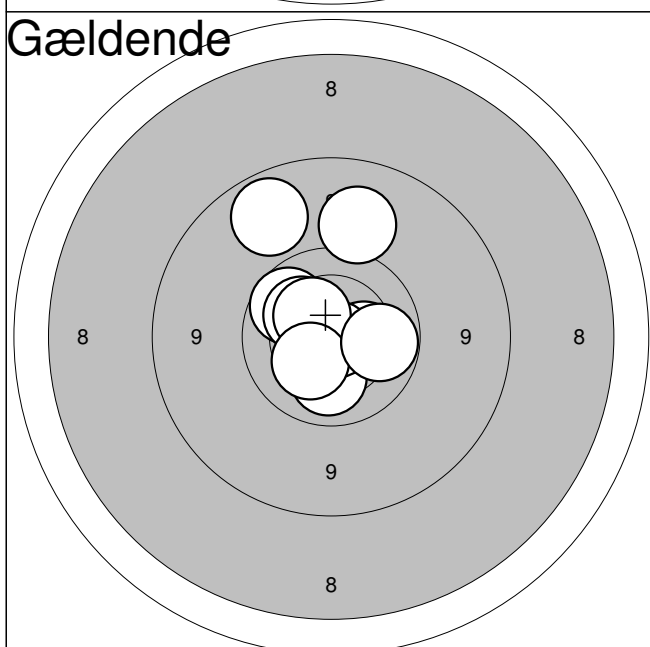

11:	9,9	↗
12:	10,2	↗
13:	10,3	→
14:	9,2	↑
15:	10,2	↓
16:	10,8*	↘
17:	10,4	↗
18:	9,0	↗
19:	10,3	↘
20:	10,0	→

**Serie: 97,0**

**Sum: 191,0**

Midtdjurs Skytteforening

ÅK2

Jyllandsstævne 2011 - riffel

Aalborg Skyttekreds

**Prøveskud**

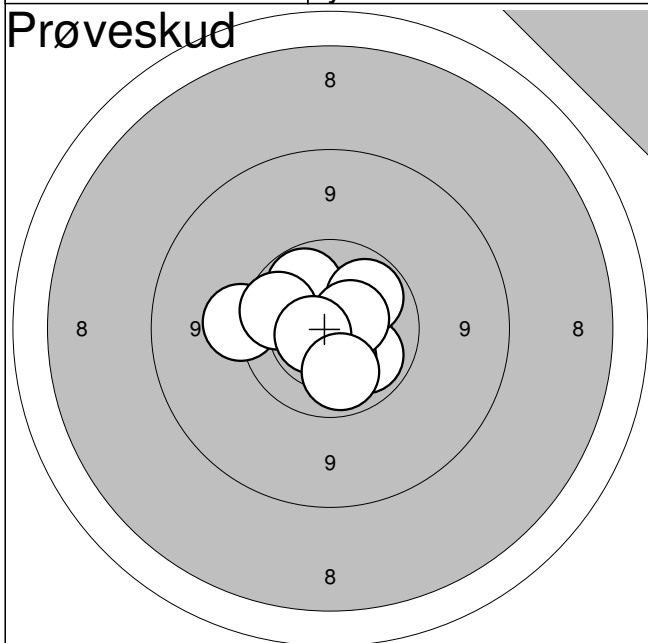

1:	10,7*	↘
2:	9,5	←
3:	10,0	↗
4:	9,9	←
5:	10,1	↘
6:	10,3	↘
7:	10,0	↗
8:	10,5*	↗
9:	10,6*	←
10:	10,1	↘

**Serie: 98,0**

**Sum: 0,0**

**Gældende**

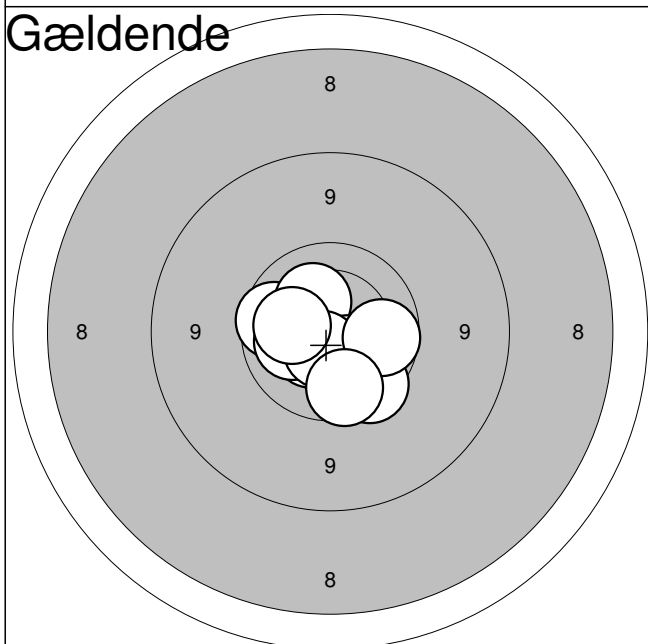

1:	9,8	↘
2:	10,4	↘
3:	9,9	←
4:	10,3	↗
5:	10,2	←
6:	10,4	↘
7:	10,6*	↘
8:	9,9	→
9:	10,2	←
10:	9,9	↘

**Serie: 96,0**

**Sum: 96,0**

**Gældende**

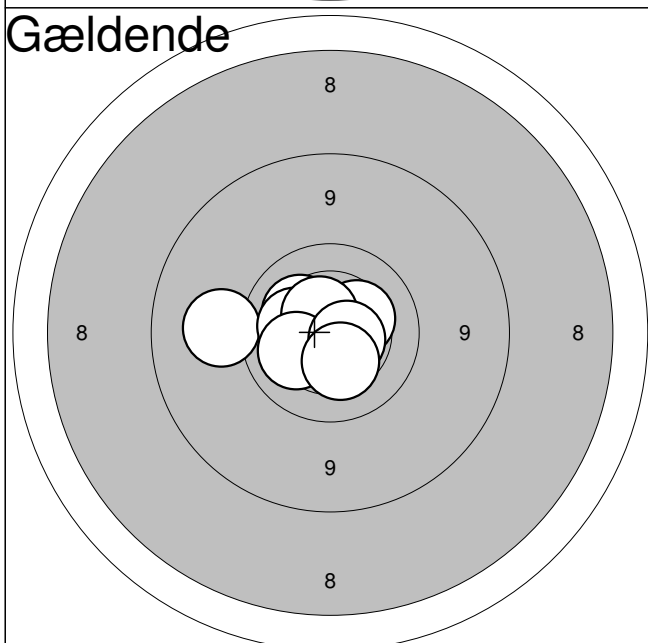

11:	10,9*	→
12:	10,4	↗
13:	9,3	←
14:	10,9*	←
15:	10,3	↗
16:	10,3	←
17:	10,6*	↗
18:	10,2	↘
19:	10,6*	↘
20:	10,3	↘

**Serie: 99,0**

**Sum: 195,0**



Hold  
**46**Bane  
**7****Simon Andersen**

Vilsted Skf.

BK1

Jyllandsstævne 2011 - riffel

Aalborg Skyttekreds

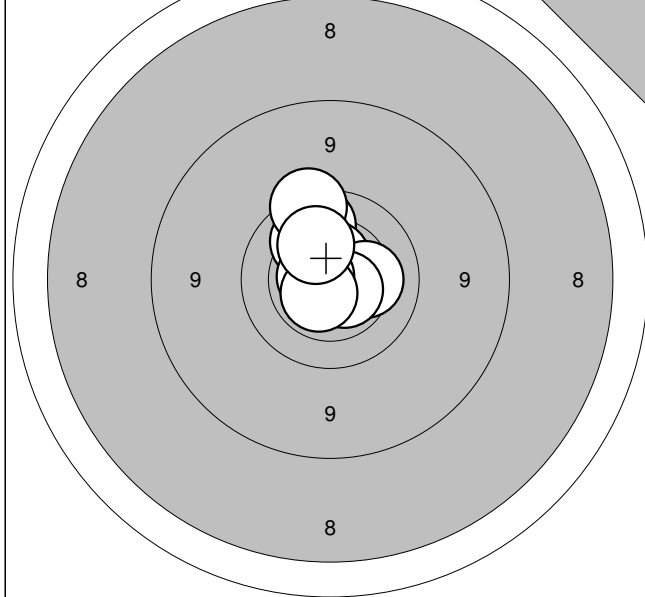
**Prøveskud**

1:	9,9	↑
2:	10,1	↗
3:	9,7	↑
4:	10,6*	↑
5:	10,3	→
6:	10,6*	↘
7:	10,7*	←
8:	10,6*	↙
9:	10,2	↑

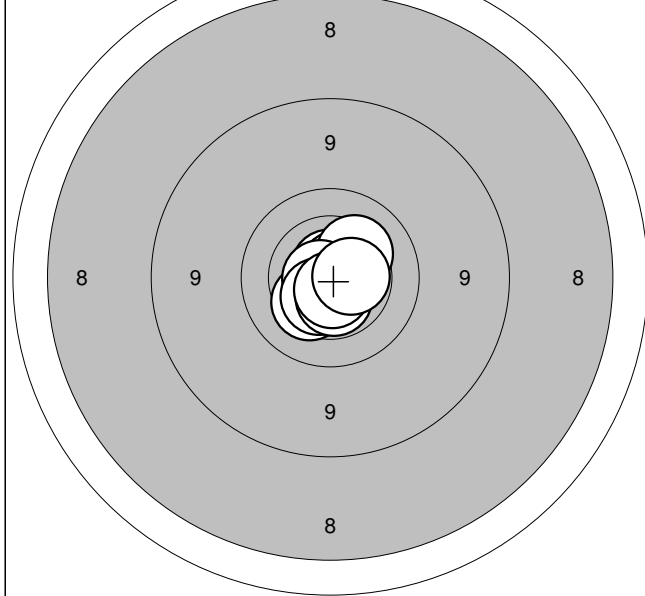
Serie: **88,0**Sum: **0,0****Gældende**

1:	10,8*	↑
2:	10,3	↙
3:	10,7*	↗
4:	10,3	↗
5:	10,7*	→
6:	10,8*	←
7:	10,5*	↙
8:	10,5*	↙
9:	10,7*	↙
10:	10,5*	→

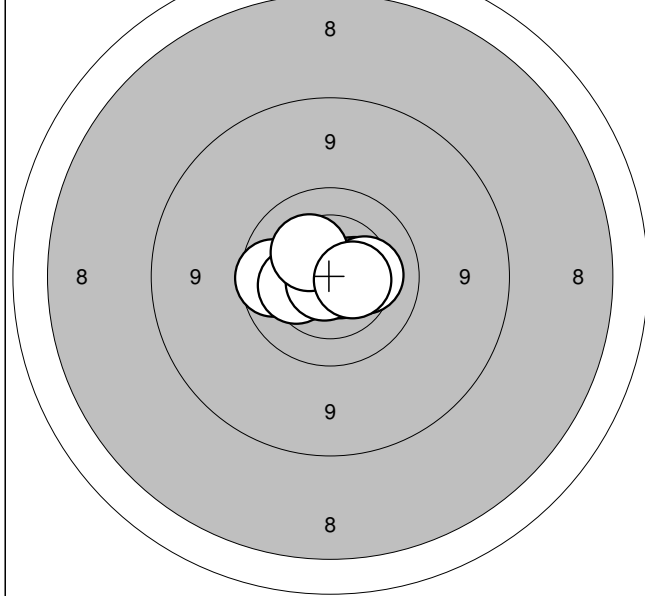
Serie: **100,0**Sum: **100,0****Gældende**

11:	9,9	←
12:	10,5	→
13:	10,7*	→
14:	10,6*	→
15:	10,7*	↗
16:	10,3	←
17:	10,8*	↙
18:	10,3	→
19:	10,3	↗
20:	10,5*	→

Serie: **99,0**Sum: **199,0**

Jyllandsstævne 2011

Hold  
**46**Bane  
**8****Christian S. Nielsen**

Vilsted Skf.

BK3

Jyllandsstævne 2011 - riffel

Aalborg Skyttekreds

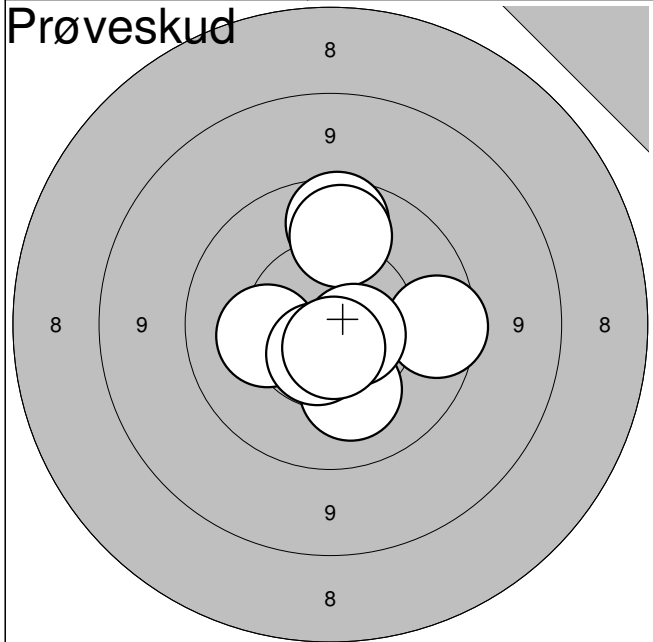
**Prøveskud**

1:	9,9	↑
2:	10,0	↑
3:	9,8	→
4:	10,2	↓
5:	10,3	←
6:	10,7*	→
7:	10,6*	↓
8:	10,7*	↓

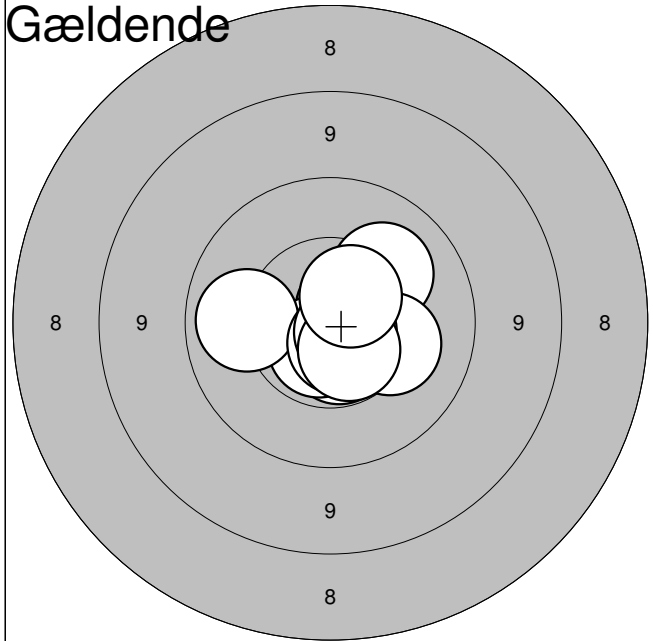
Serie: **78,0**Sum: **0,0****Gældende**

1:	10,7*	↗
2:	10,6*	↓
3:	10,2	↗
4:	10,7*	↓
5:	10,1	←
6:	10,7*	↓
7:	10,3	→
8:	10,8*	↘
9:	10,6*	↓
10:	10,6*	↗

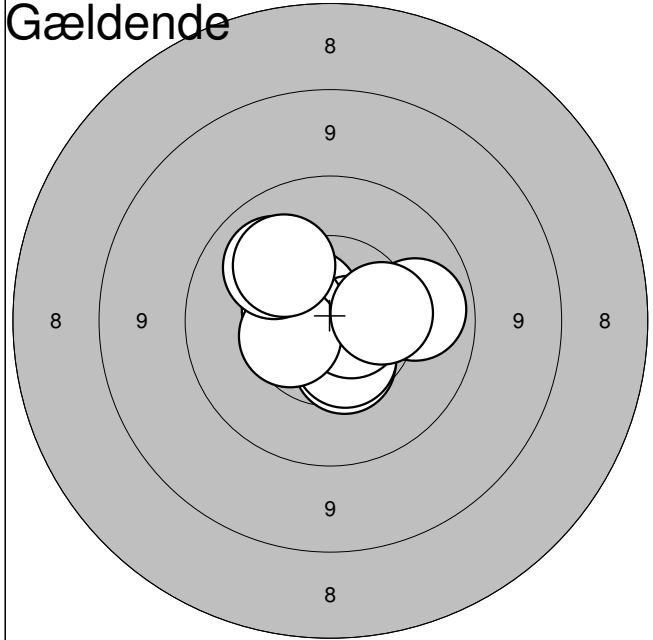
Serie: **100,0**Sum: **100,0****Gældende**

11:	10,5	↓
12:	10,6*	↗
13:	10,5	↓
14:	10,7*	→
15:	10,0	→
16:	10,6	←
17:	10,5	←
18:	10,1	↗
19:	10,2	↗
20:	10,4	→

Serie: **100,0**Sum: **200,0**

Jyllandsstævne 2011

Hold  
**46**Bane  
**9****Cecile Severin Ingvarlsen**

Mou &amp; Omegns Skf.

BK4

Jyllandsstævne 2011 - riffel

Aalborg Skyttekreds

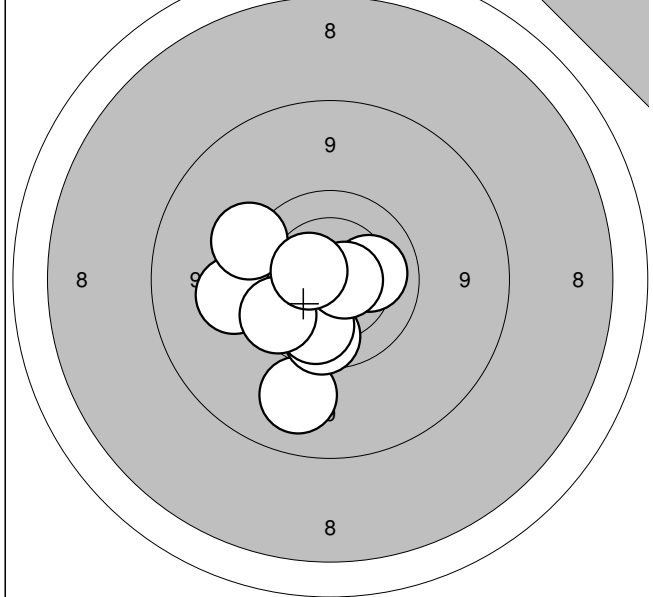
**Prøveskud**

1:	9,2	↓
2:	9,9	↓
3:	9,4	←
4:	10,0	↓
5:	10,2	→
6:	10,7*	→
7:	9,8	←
8:	9,5	←
9:	10,5*	←

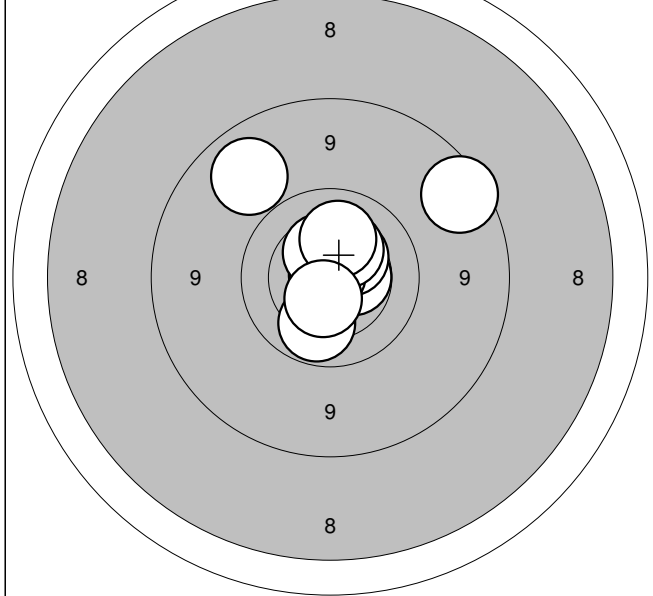
Serie: **85,0**Sum: **0,0****Gældende**

1:	10,0	↓
2:	10,5*	→
3:	8,9	↗
4:	9,1	↗
5:	10,4	↗
6:	10,9*	↗
7:	10,3	↗
8:	10,4	↗
9:	10,2	↗
10:	10,5*	↓

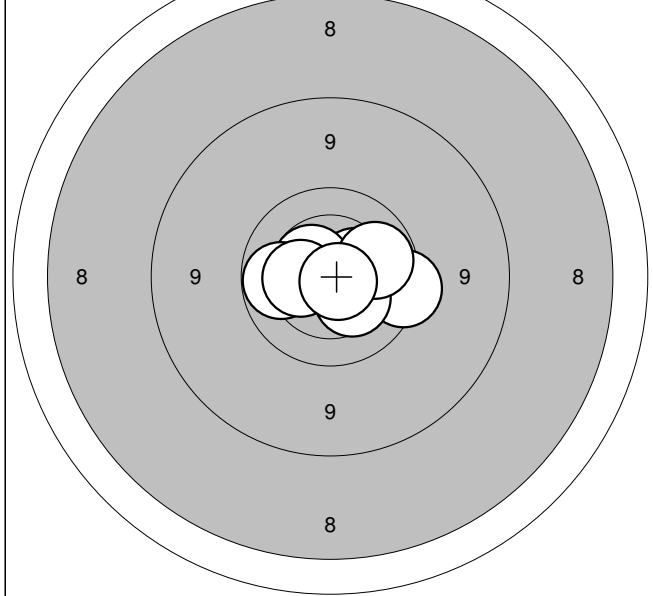
Serie: **97,0**Sum: **97,0****Gældende**

11:	9,7	→
12:	10,4	→
13:	10,4	↓
14:	10,5*	↗
15:	10,8*	↓
16:	10,5*	↗
17:	10,0	→
18:	10,0	←
19:	10,4	←
20:	10,8*	↘

Serie: **99,0**Sum: **196,0**

Jyllandsstævne 2011

Hold

46

Bane

10

## Simone Severin Ingvartsen

Mou &amp; Omegns Skf.

BK3

Jyllandsstævne 2011 - riffel

Aalborg Skyttekreds

## Prøveskud

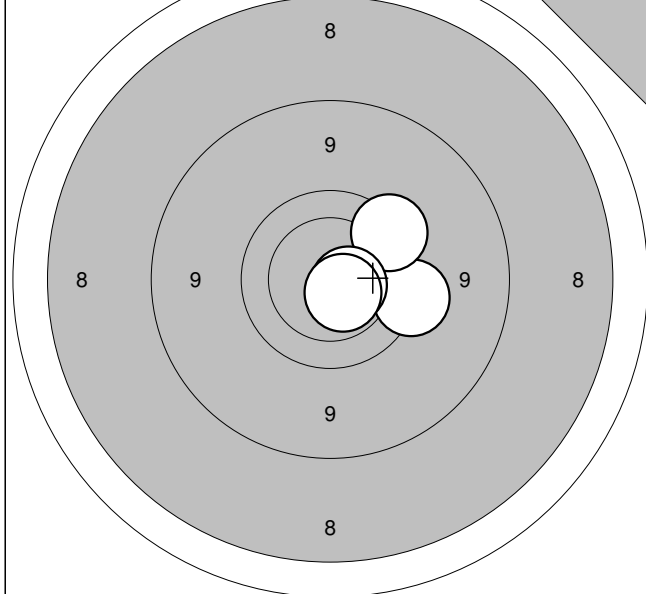

1:	9,6	→
2:	9,7	↗
3:	10,6*	→
4:	10,6*	↘

Serie: 38,0

Sum: 0,0

## Gældende

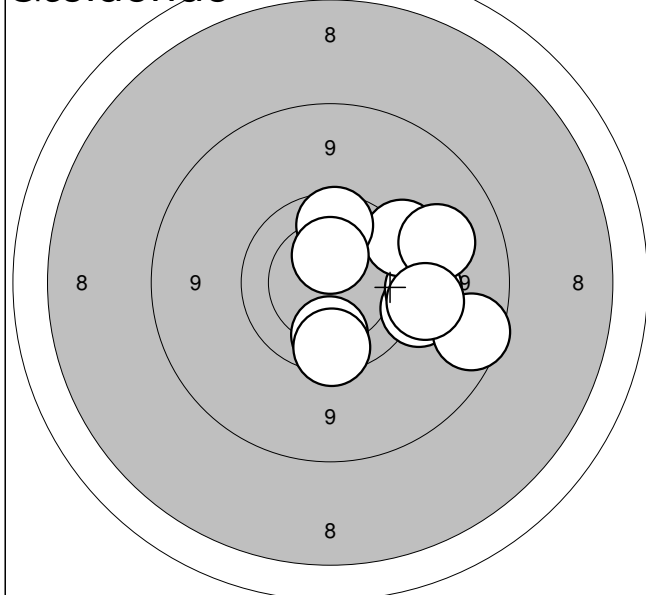

1:	9,5	→
2:	9,9	↓
3:	8,9	→
4:	9,5	→
5:	9,6	↗
6:	9,9	↑
7:	9,2	→
8:	9,4	→
9:	10,4	↑
10:	9,8	↓

Serie: 90,0

Sum: 90,0

## Gældende

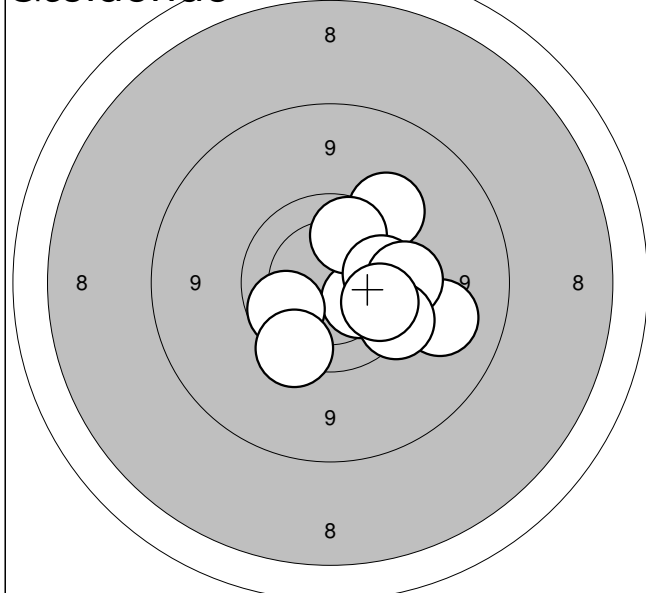

11:	9,5	↗
12:	10,3	↘
13:	10,0	↗
14:	9,9	→
15:	9,9	↖
16:	9,2	→
17:	9,7	→
18:	9,7	↘
19:	9,9	→
20:	9,7	↘

Serie: 92,0

Sum: 182,0

Jyllandsstævne 2011

Hold

46

Bane

11

Mathias Christensen

Vilsted Skf.

BK1

Jyllandsstævne 2011 - riffel

Aalborg Skyttekreds

Prøveskud

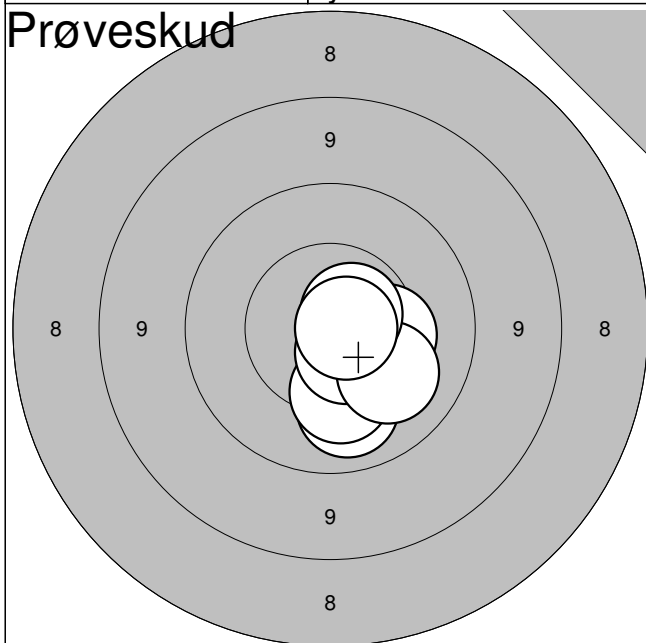

1: 10,1  
 2: 10,3  
 3: 10,4  
 4: 10,6\*  
 5: 10,2  
 6: 10,7\*  
 7: 10,8\*

↓  
 ↓  
 →  
 ↓  
 ↓  
 ↗  
 →

Serie: 70,0

Sum: 0,0

Gældende

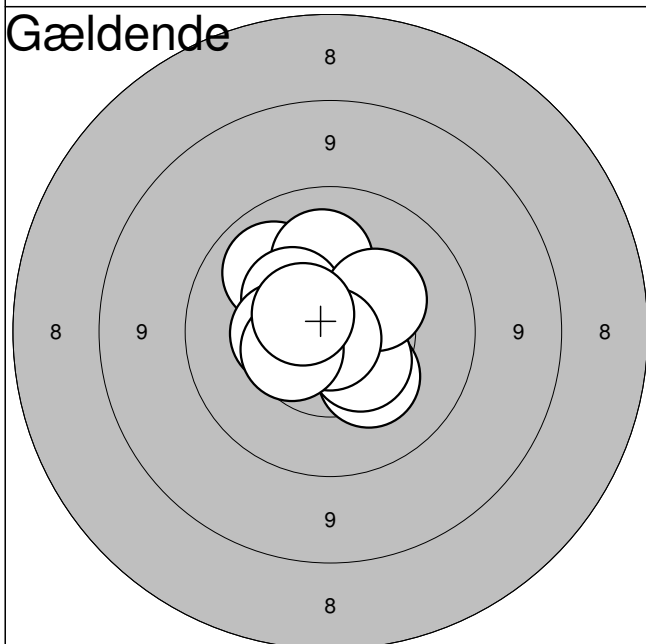

1: 10,1  
 2: 10,2  
 3: 10,3  
 4: 10,5  
 5: 10,4  
 6: 10,4  
 7: 10,4  
 8: 10,9\*  
 9: 10,5  
 10: 10,6\*

↗  
 ↑  
 ↓  
 ↓  
 ↗  
 ←  
 ↗  
 ↓  
 ←  
 ↗

Serie: 100,0

Sum: 100,0

Gældende

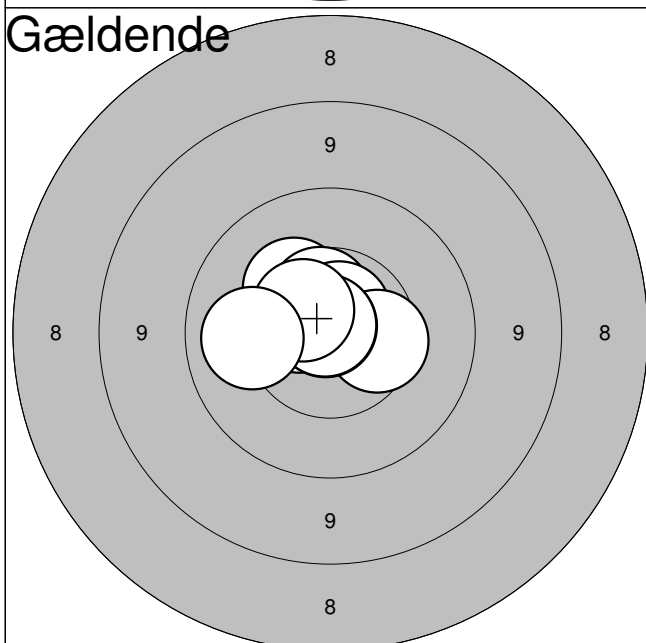

11: 10,6\*  
 12: 10,7\*  
 13: 10,4  
 14: 10,6  
 15: 10,7\*  
 16: 10,4  
 17: 10,9\*  
 18: 10,9\*  
 19: 10,6  
 20: 10,1

←  
 ↑  
 ↗  
 ↑  
 ↗  
 →  
 ↗  
 ↗  
 ↗  
 ←

Serie: 100,0

Sum: 200,0

Jyllandsstævne 2011

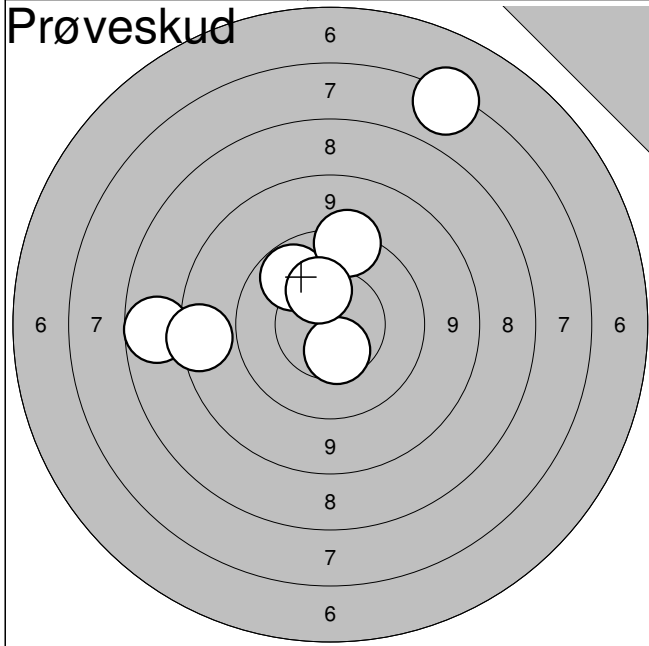

1:	6,5	↗
2:	7,9	←
3:	10,5	↘
4:	10,0	↗
5:	8,7	←
6:	9,6	↑
7:	10,4	↑

<b>Serie:</b>	<b>60,0</b>
<b>Sum:</b>	<b>0,0</b>

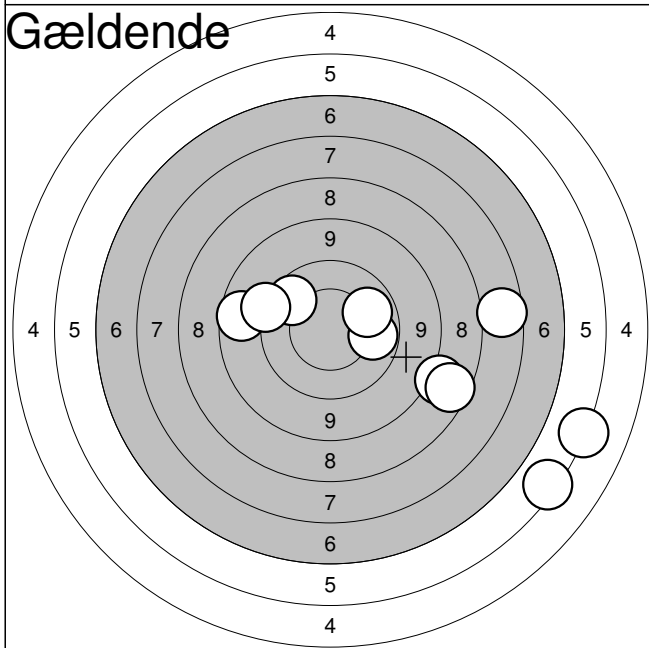

1:	10,0	→
2:	6,9	→
3:	4,4	→
4:	8,1	→
5:	10,0	→
6:	9,9	↗
7:	7,8	↘
8:	4,6	↘
9:	8,9	←
10:	9,4	←

<b>Serie:</b>	<b>75,0</b>
<b>Sum:</b>	<b>75,0</b>

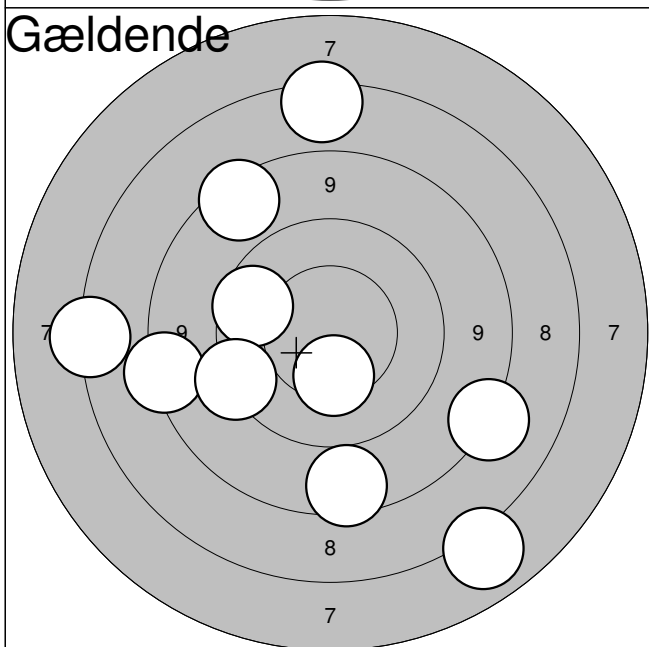

11:	9,8	←
12:	8,5	←
13:	7,5	←
14:	8,4	↘
15:	9,5	↖
16:	8,8	↘
17:	8,7	↗
18:	7,6	↑
19:	7,1	↘
20:	10,4	↘

<b>Serie:</b>	<b>81,0</b>
<b>Sum:</b>	<b>156,0</b>

Ulsted Skf.

ÅK2

Jyllandsstævne 2011 - riffel

Aalborg Skyttekreds

## Prøveskud

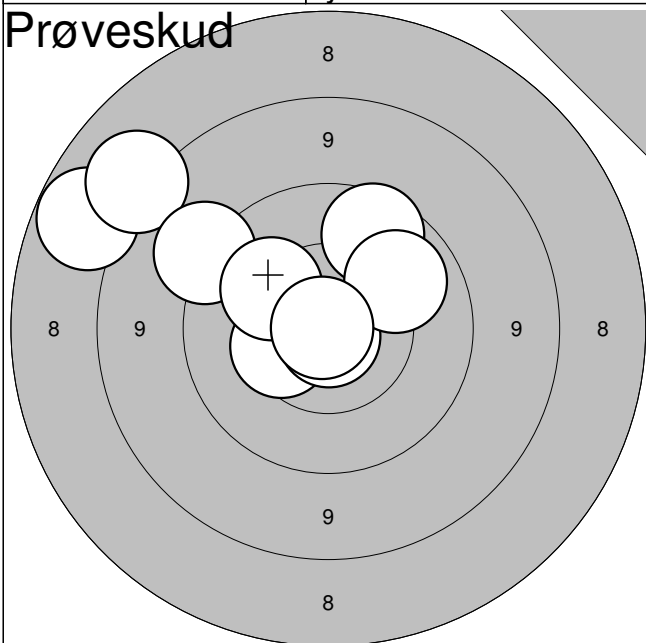

1: 8,0



2: 8,2



3: 9,4



4: 9,8



5: 10,4



6: 10,2



7: 10,9\*



8: 10,1



9: 10,9\*



Serie:

84,0

Sum:

0,0

## Gældende

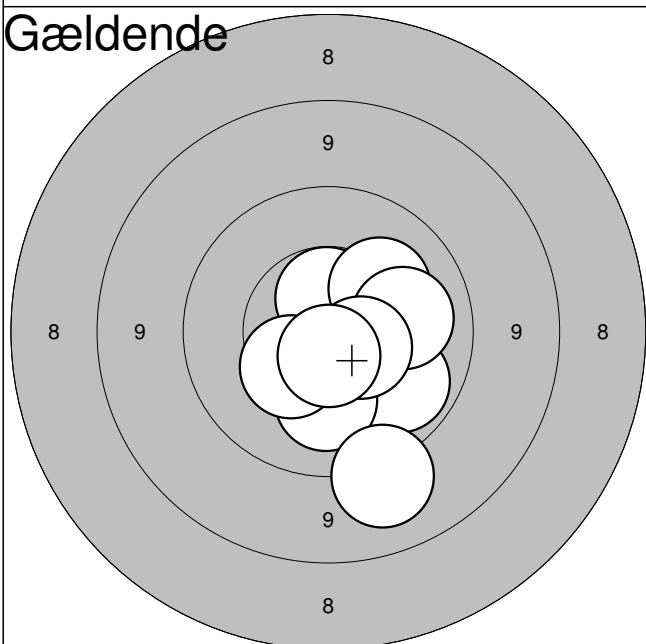

1: 10,5



2: 10,6\*



3: 10,0



4: 10,2



5: 10,2



6: 9,2



7: 10,4



8: 10,1



9: 10,6



10: 10,7\*



Serie:

99,0

Sum:

99,0

## Gældende

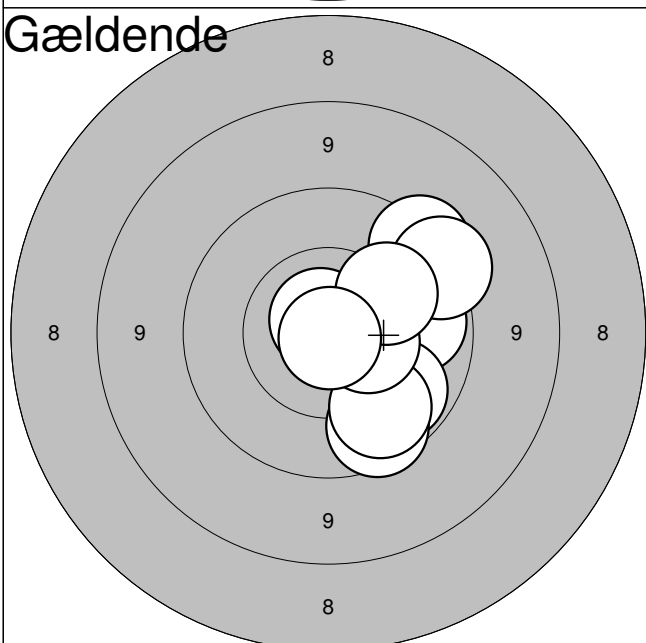

11: 10,0



12: 10,0



13: 9,8



14: 10,0



15: 9,6



16: 10,8\*



17: 10,5



18: 9,5



19: 10,2



20: 10,9\*



Serie:

97,0

Sum:

196,0

Hold

47

Bane

3

## Mathilde Aagaard Christensen

Vilsted Skf.

BK3

Jyllandsstævne 2011 - riffel

Aalborg Skyttekreds

## Prøveskud

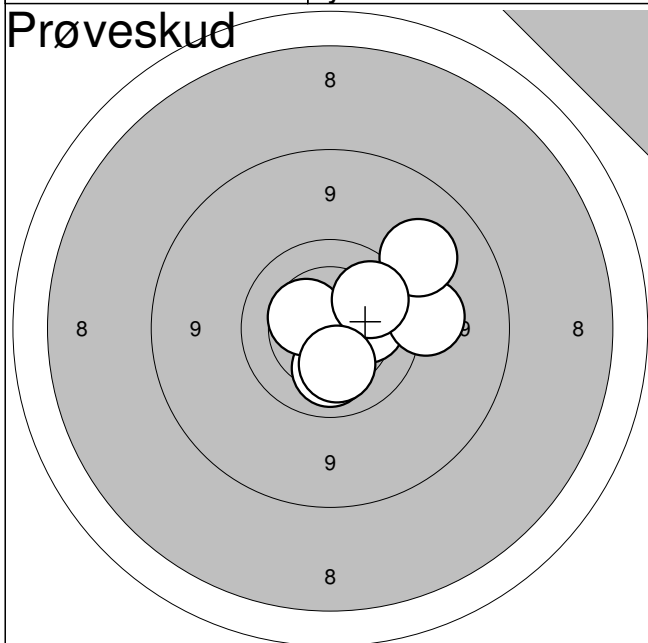

1: 10,2  
 2: 10,2  
 3: 10,4  
 4: 9,4  
 5: 9,3  
 6: 10,0  
 7: 10,2

↓  
 →  
 ←  
 →  
 ↗  
 ↗  
 ↓

Serie: 68,0

Sum: 0,0

## Gældende

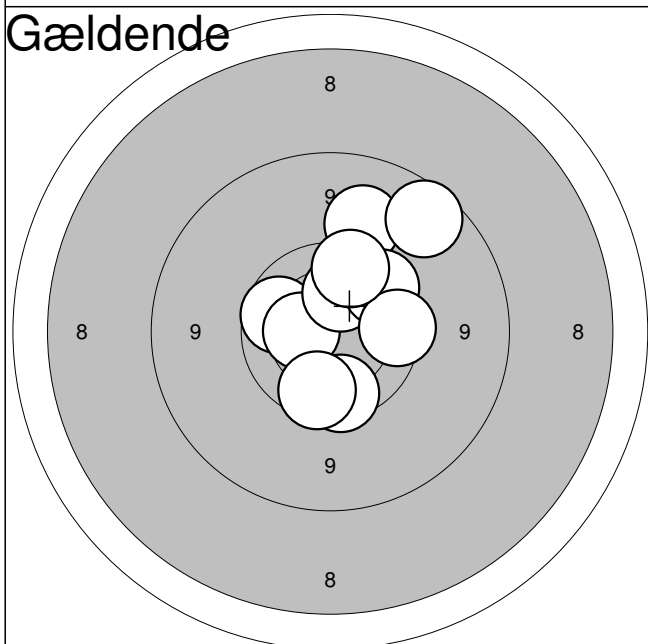

1: 9,3  
 2: 9,9  
 3: 10,4  
 4: 10,2  
 5: 9,8  
 6: 9,8  
 7: 8,9  
 8: 9,8  
 9: 9,8  
 10: 9,8

↑  
 ←  
 ←  
 ↑  
 ↗  
 ↓  
 ↗  
 →  
 ↓  
 ↑

Serie: 91,0

Sum: 91,0

## Gældende

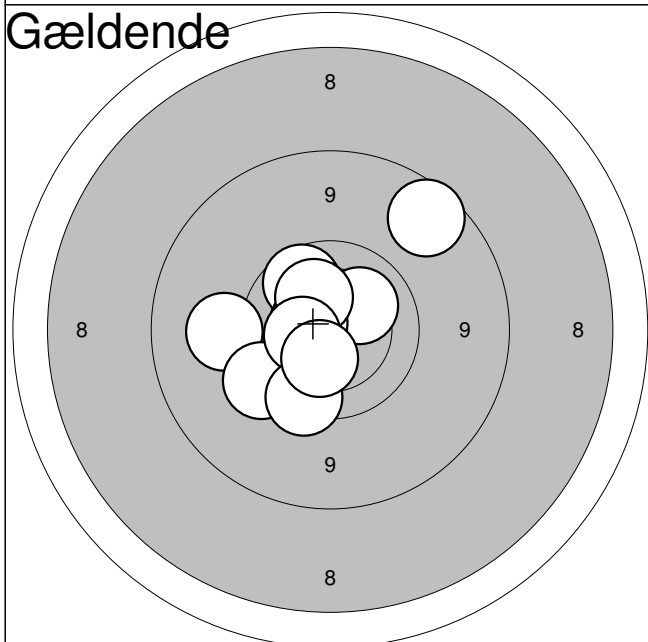

11: 9,9  
 12: 9,3  
 13: 10,2  
 14: 10,5\*  
 15: 10,2  
 16: 8,9  
 17: 9,6  
 18: 10,4  
 19: 9,7  
 20: 10,4

↑  
 ←  
 ↗  
 ←  
 ↑  
 ↗  
 ←  
 ←  
 ↓  
 ↓

Serie: 94,0

Sum: 185,0

Jyllandsstævne 2011



Hold  
**47**Bane  
**5****Louise Bedsted**

Vester Han Herred Skytteforeni

2

Jyllandsstævne 2011 - riffel

Aalborg Skyttekreds

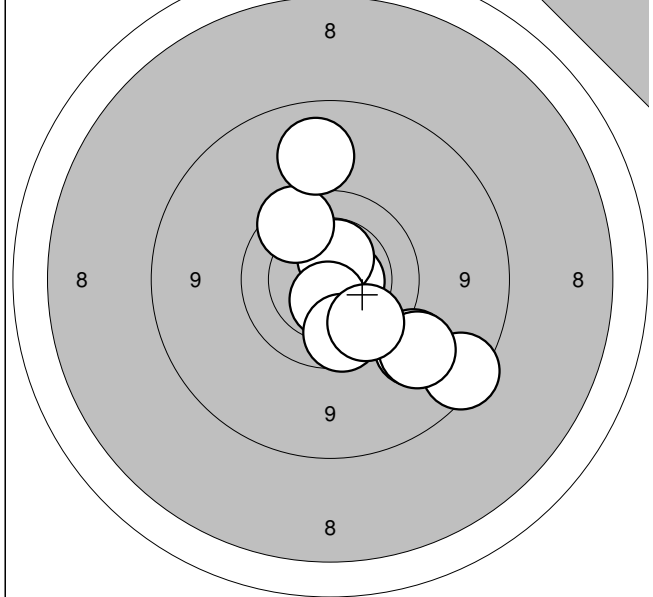
**Prøveskud**

1:	10,6*	→
2:	10,5*	↑
3:	9,8	↗
4:	9,3	↘
5:	8,8	↘
6:	10,5*	↘
7:	9,9	↘
8:	9,3	↘
9:	9,9	↘
10:	9,1	↑

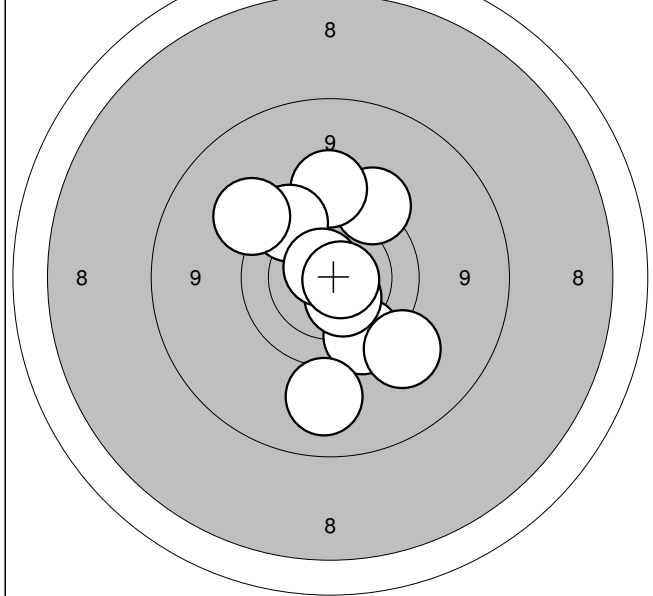
Serie: **92,0**Sum: **0,0****Gældende**

1:	9,8	↘
2:	10,5	↘
3:	9,4	↘
4:	9,6	↗
5:	9,5	↑
6:	9,8	↗
7:	9,2	↘
8:	10,7*	↗
9:	10,7*	→
10:	9,4	↗

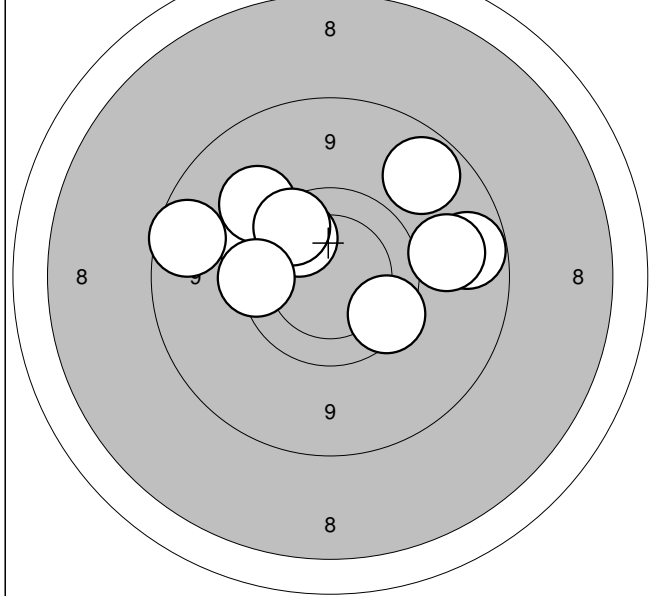
Serie: **93,0**Sum: **93,0****Gældende**

11:	9,6	↗
12:	8,9	←
13:	9,4	↗
14:	9,0	→
15:	9,0	↗
16:	9,8	↘
17:	10,0	↗
18:	9,2	→
19:	9,8	↗
20:	9,7	←

Serie: **90,0**Sum: **183,0**

Jyllandsstævne 2011

Hold

47

Bane

6

Jarl Linde

Vilsted Skf.

3

Jyllandsstævne 2011 - riffel

Aalborg Skyttekreds

Prøveskud

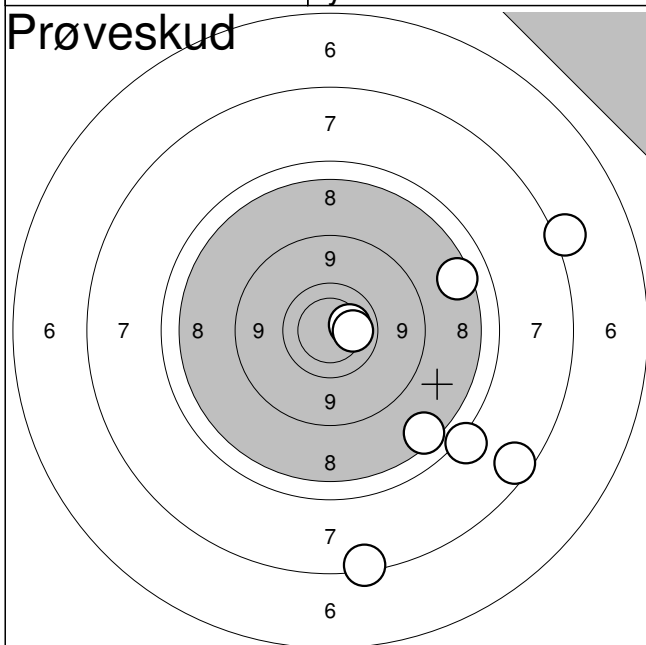

1: 6,7  
 2: 8,1  
 3: 10,2  
 4: 8,1  
 5: 6,9  
 6: 7,6  
 7: 6,5  
 8: 10,1

↓  
 ↓  
 →  
 →  
 ↓  
 ↓  
 →  
 →

Serie: 61,0

Sum: 0,0

Gældende

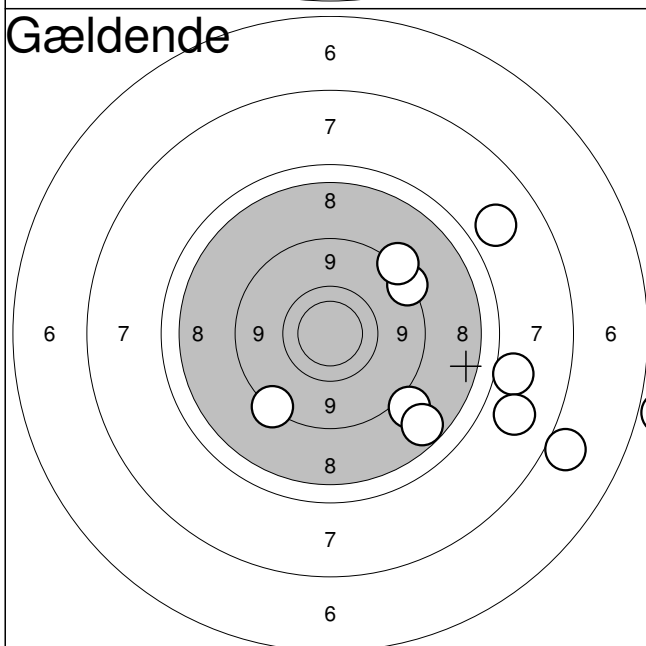

1: 7,3  
 2: 8,7  
 3: 7,4  
 4: 8,7  
 5: 8,7  
 6: 7,2  
 7: 0,0  
 8: 8,5  
 9: 6,4  
 10: 8,2

→  
 →  
 →  
 →  
 ↓  
 ↓  
 →  
 ↓  
 ↓  
 ↓

Serie: 67,0

Sum: 67,0

Gældende

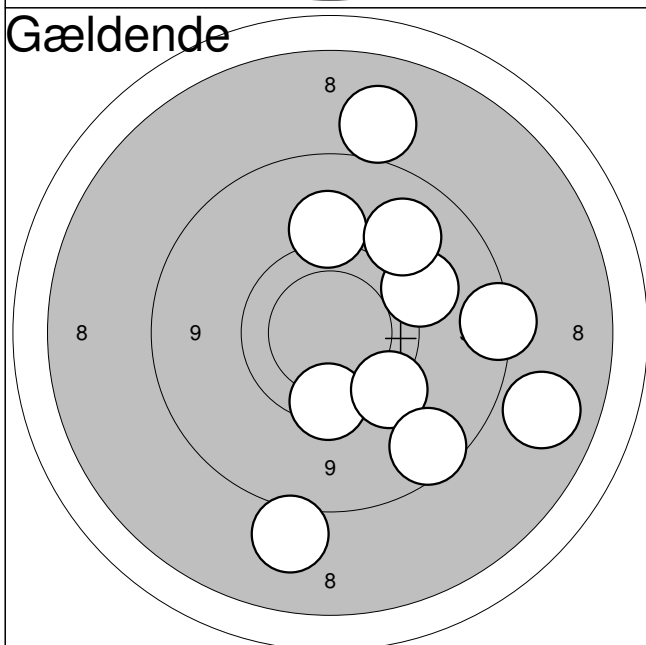

11: 8,8  
 12: 8,3  
 13: 9,4  
 14: 9,7  
 15: 9,4  
 16: 8,4  
 17: 9,6  
 18: 9,2  
 19: 8,9  
 20: 8,5

→  
 →  
 ↑  
 ↓  
 →  
 ↑  
 ↓  
 →  
 ↓  
 ↓

Serie: 85,0

Sum: 152,0

Jyllandsstævne 2011

Hold  
**47**Bane  
**7****Philip Kristensen**

Midtdjurs Skytteforening

BK1

Jyllandsstævne 2011 - riffel

Aalborg Skyttekreds

Prøveskud

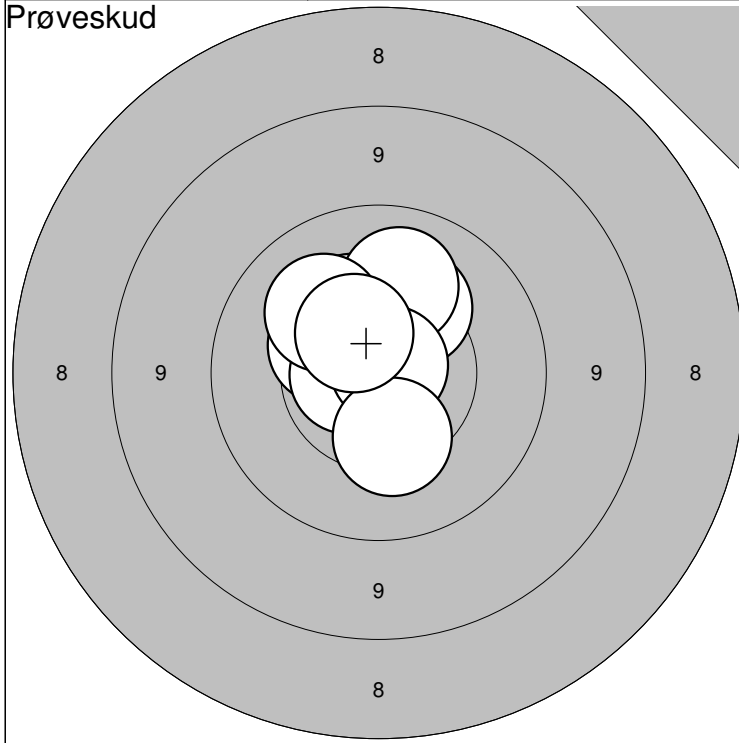

Prøveskud

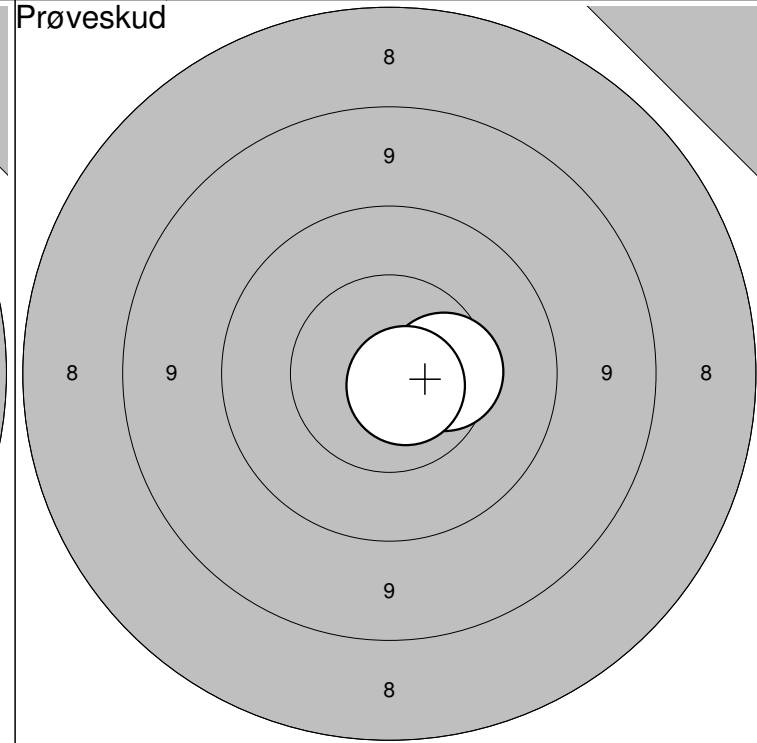

1:10,3 ↗  
2:10,4 ↖  
3:10,4 ↗  
4:10,6\* ↗  
5:10,7\* ←

6:10,1 ↗  
7:10,2 ↖  
8:10,8\* ↗  
9:10,3 ↓  
10:10,5 ↗

Serie: 100,0

Sum: 0,0

11:10,4 →  
12:10,8\* ↘

Serie: 20,0

Sum: 0,0

Gældende

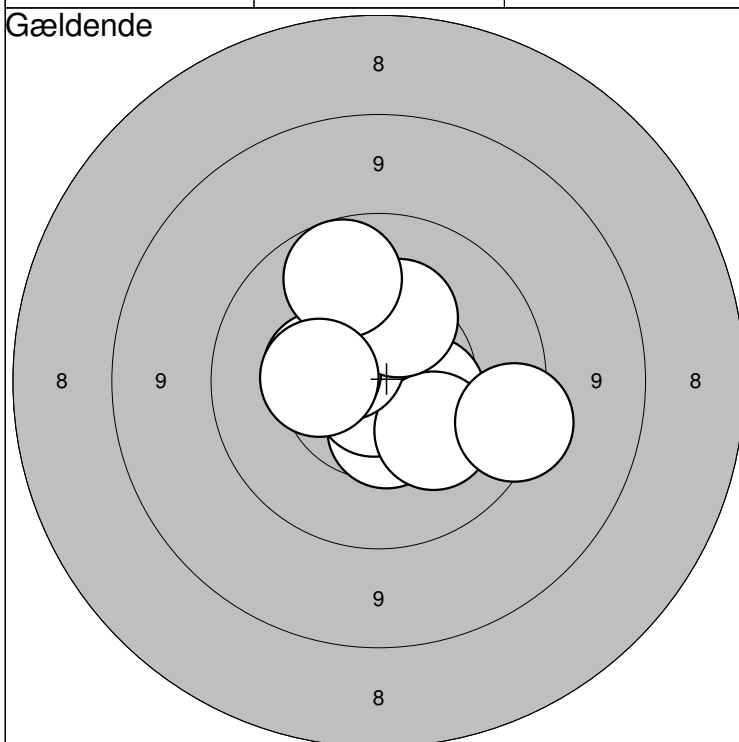

Gældende

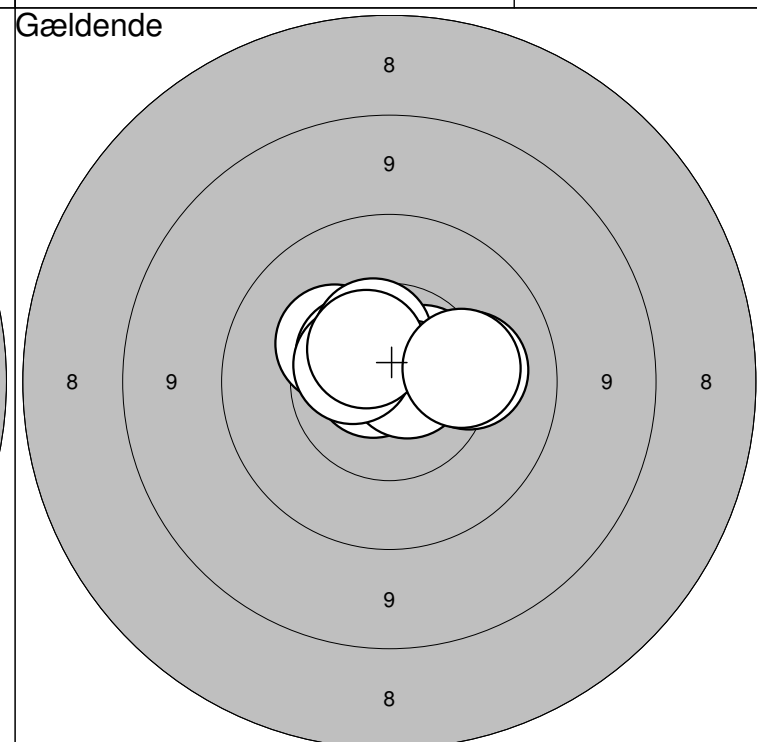

1:10,5 →  
2:10,5 ↓  
3:10,8\* ↓  
4:10,3 ↓  
5: 9,6 →

6:10,6\* ↖  
7:10,4 ←  
8:10,3 ↗  
9:10,0 ↗  
10:10,4 ←

Serie: 99,0

Sum: 99,0

11:10,8\* ←  
12:10,3 ↖  
13:10,6 ↗  
14:10,6\* ↗  
15:10,5 ↗

16:10,8\* →  
17:10,6\* ←  
18:10,2 →  
19:10,6\* ↗  
20:10,3 →

Serie: 100,0

Sum: 199,0

Jyllandsstævne 2011

Hold

47

Bane

9

Simon Vissing

Hjørring Skytteforening

J1

Jyllandsstævne 2011 - riffel

Aalborg Skyttekreds

Prøveskud

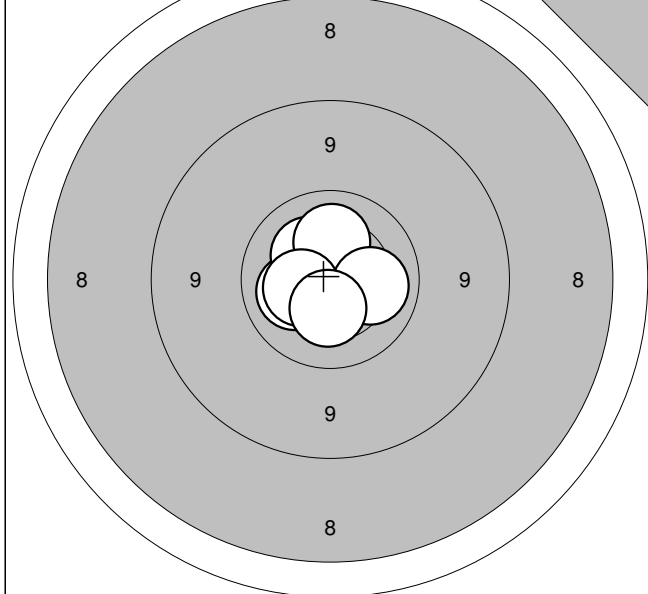

1: 10,2



2: 10,5\*



3: 10,8\*



4: 10,3



5: 10,2



6: 10,1



7: 10,4



8: 10,4



Serie:

80,0

Sum:

0,0

Gældende

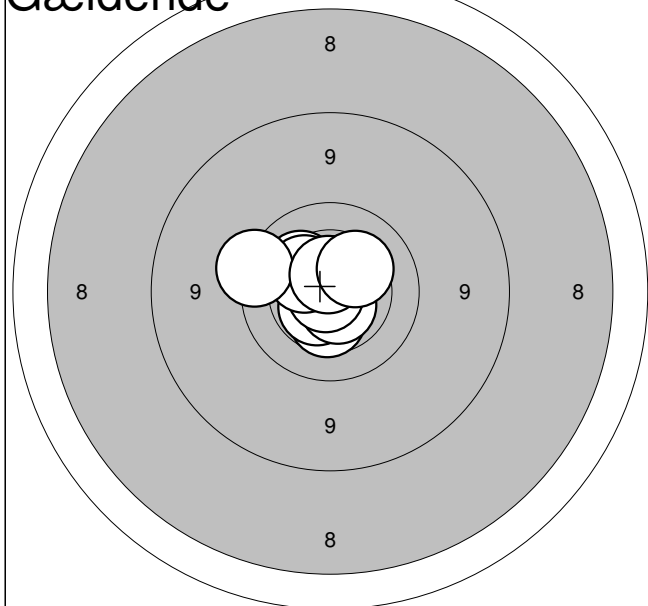

1: 10,4



2: 10,6\*



3: 10,6\*



4: 10,6\*



5: 10,2



6: 10,9\*



7: 10,4



8: 9,6



9: 10,6\*



10: 10,3



Serie:

99,0

Sum:

99,0

Gældende

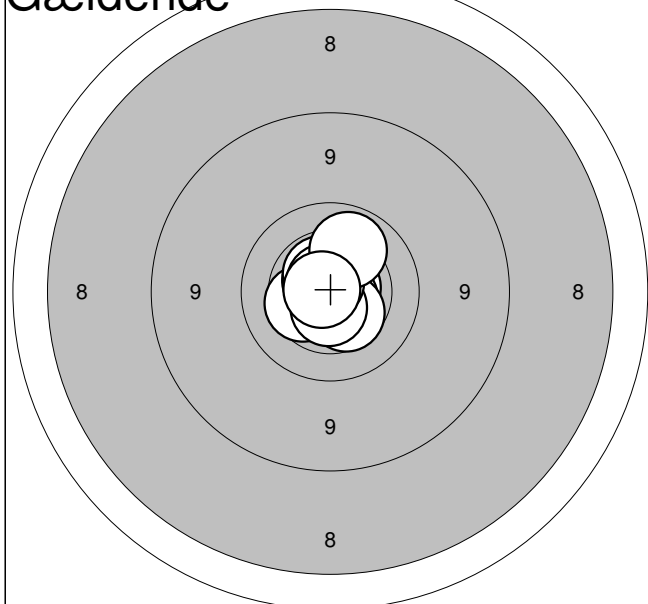

11: 10,4



12: 10,7\*



13: 10,7\*



14: 10,7\*



15: 10,4



16: 10,6\*



17: 10,6\*



18: 10,7\*



19: 10,1



20: 10,8\*



Serie:

100,0

Sum:

199,0

Jyllandsstævne 2011

Hold  
**47**Bane  
**10****Asbjørn Risgård Nielsen**

Vilsted Skf.

BK1

Jyllandsstævne 2011 - riffel

Aalborg Skyttekreds

Prøveskud

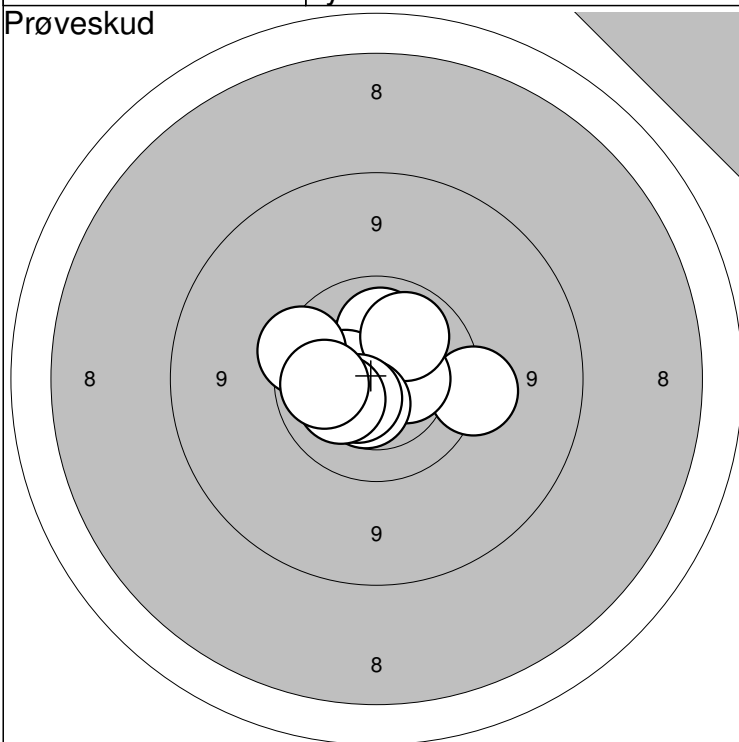

Prøveskud

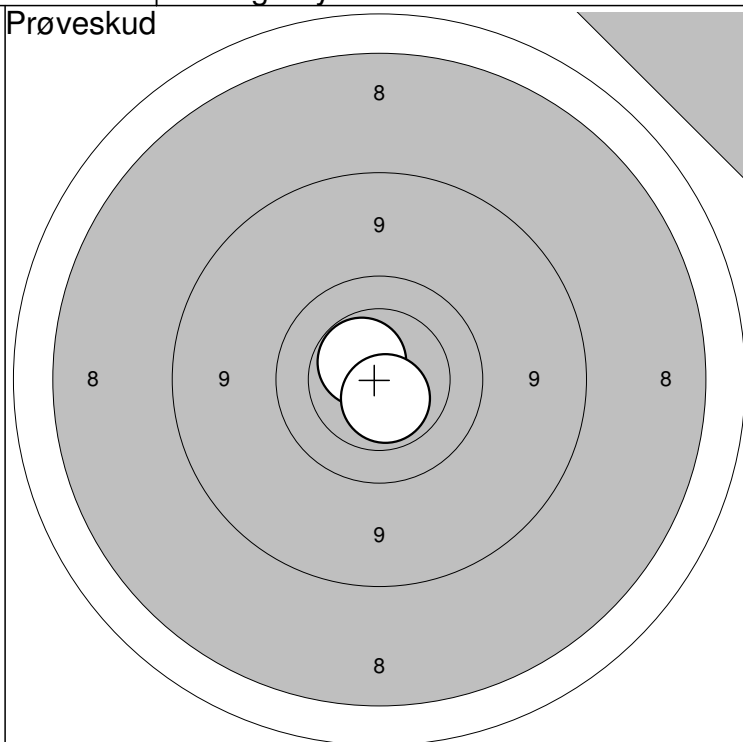

1: 9,6 →

→

6:10,5 ↓

↓

Serie: 98,0

2:10,2 ↑

↑

7:10,5 ↓

↓

3:10,4 ←

←

8: 9,8 ←

←

4:10,4 →

→

9:10,2 ←

←

5:10,1 ↗

↗

10:10,1 ←

←

Sum: 0,0

11:10,5\* ↗

↗

12:10,6\* ↓

↓

Serie: 20,0

Sum: 0,0

Gældende

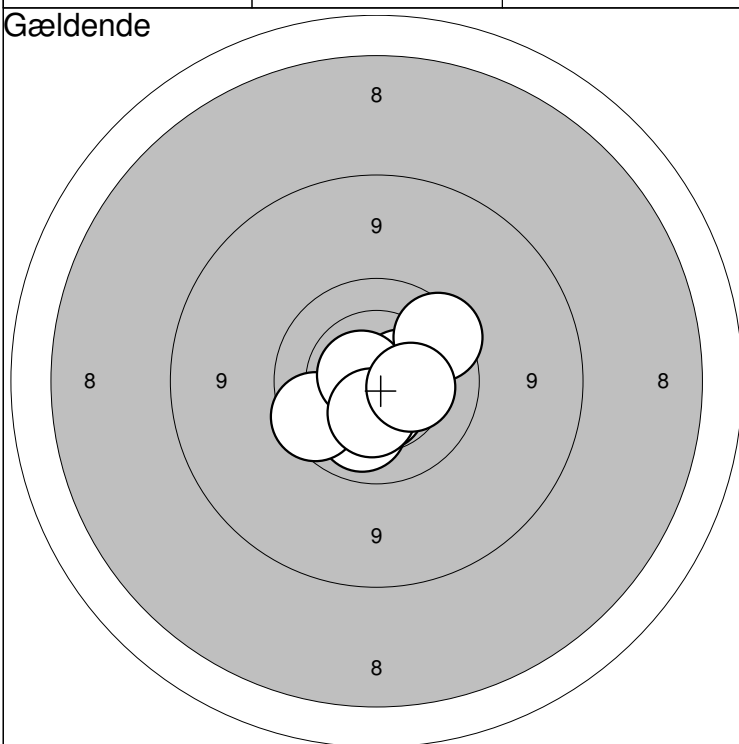

Gældende

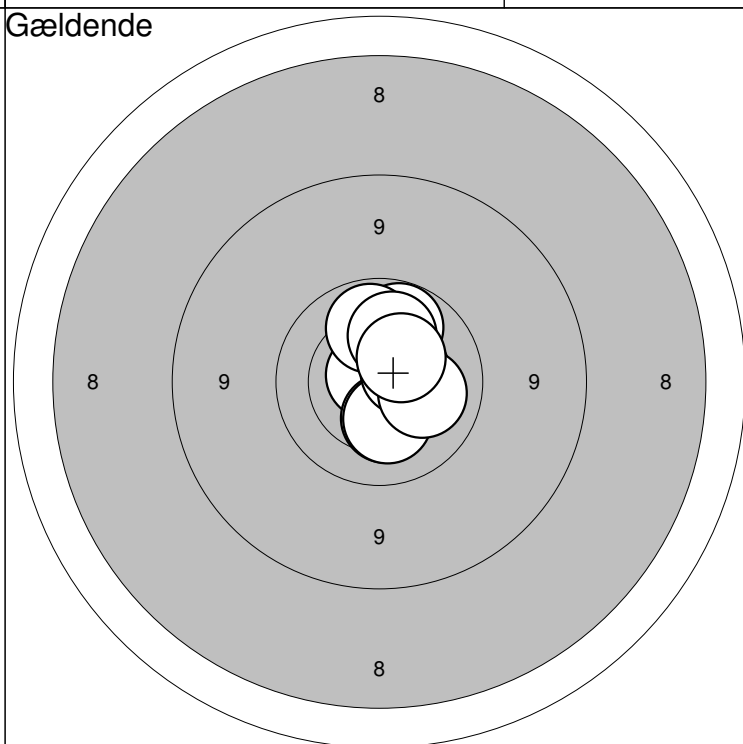

1:10,9\* →

→

6:10,5\* ↓

↓

Serie: 98,0

2:10,5\* →

→

7:10,7\* ←

←

3:10,1 ↓

↓

8: 9,8 ↗

↗

4: 9,8 ←

←

9:10,4 ↓

↓

5:10,7\* ↘

↘

10:10,4 →

→

Sum: 98,0

11:10,6\* ↘

↘

16:10,0 ↑

↑

12:10,0 ↗

↗

17:10,5 →

→

Serie: 100,0

13:10,8\* ↖

↖

18:10,1 ↑

↑

14:10,3 ↓

↓

19:10,2 →

→

15:10,3 ↓

↓

20:10,4 ↗

↗

Sum: 198,0

Jyllandsstævne 2011

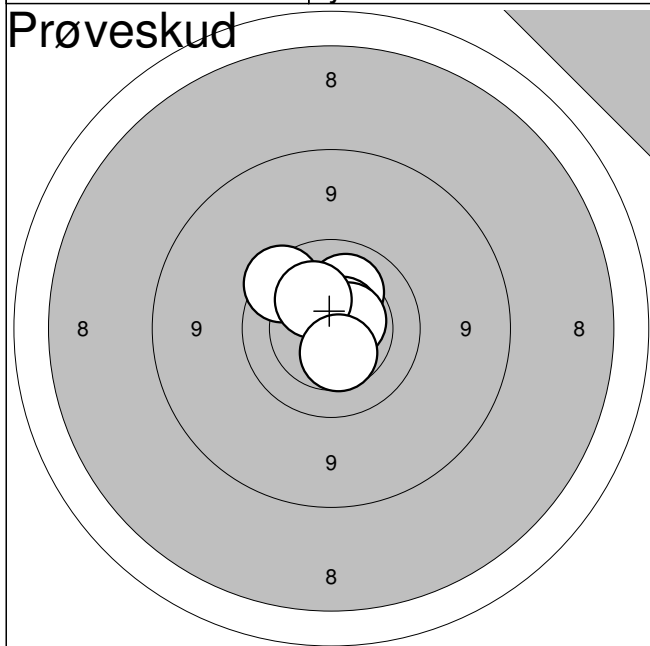

1:	10,2	↑
2:	10,6*	↗
3:	9,8	↗
4:	10,6*	→
5:	10,3	↗
6:	10,4	↓

<b>Serie:</b>	<b>59,0</b>
<b>Sum:</b>	<b>0,0</b>

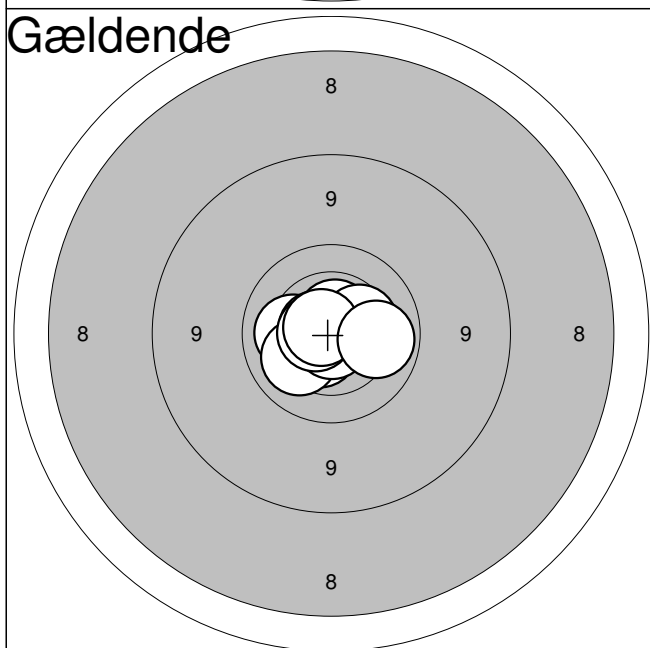

1:	10,6*	↑
2:	10,4	→
3:	10,6*	↓
4:	10,2	←
5:	10,7*	←
6:	10,2	↙
7:	10,8*	↓
8:	10,7*	←
9:	10,7*	↗
10:	10,1	→

<b>Serie:</b>	<b>100,0</b>
<b>Sum:</b>	<b>100,0</b>

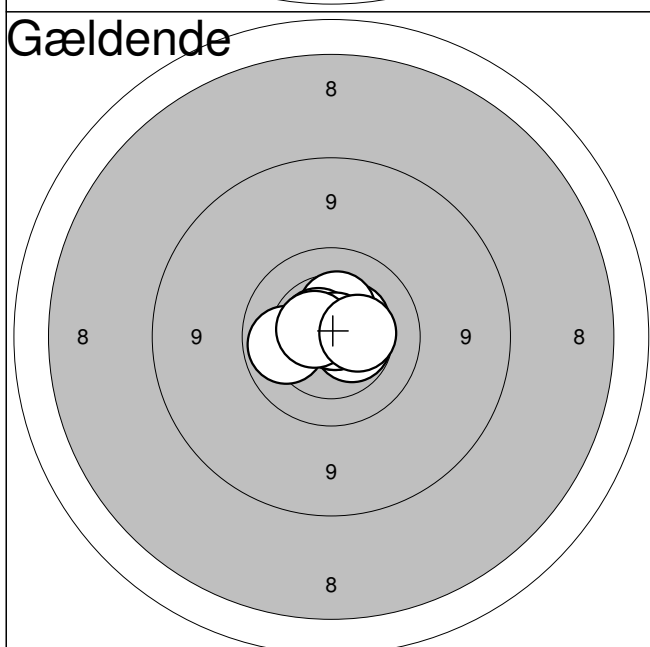

11:	10,5	↗
12:	10,8*	↗
13:	10,5*	→
14:	10,4	↑
15:	10,8*	↗
16:	10,6*	↗
17:	10,8*	↗
18:	10,1	←
19:	10,6*	←
20:	10,4	→

<b>Serie:</b>	<b>100,0</b>
<b>Sum:</b>	<b>200,0</b>

Hold  
**47**

Bane  
**12**

# Tobias Engberg Hansen

Vilsted Skf.

BK2

Jyllandsstævne 2011 - riffel

Aalborg Skyttekreds

Prøveskud

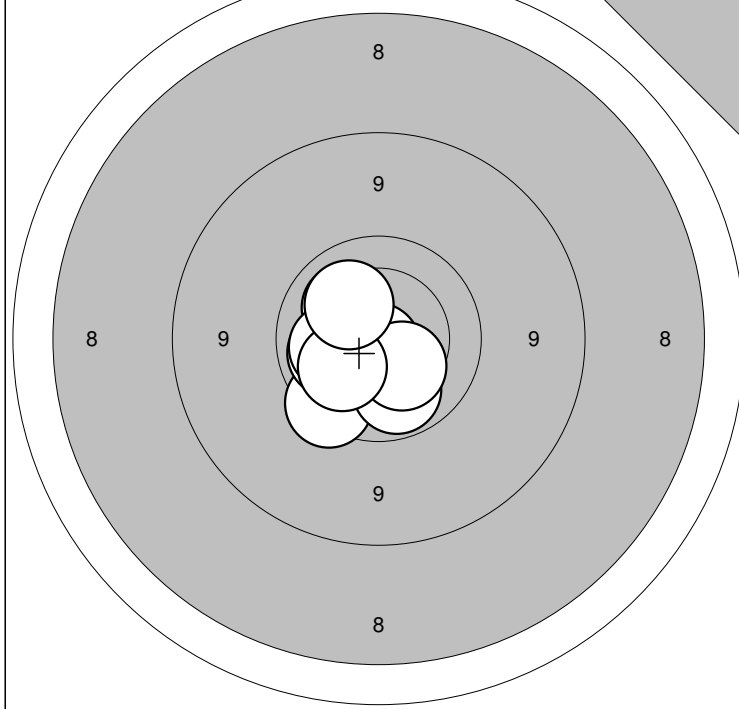

Prøveskud

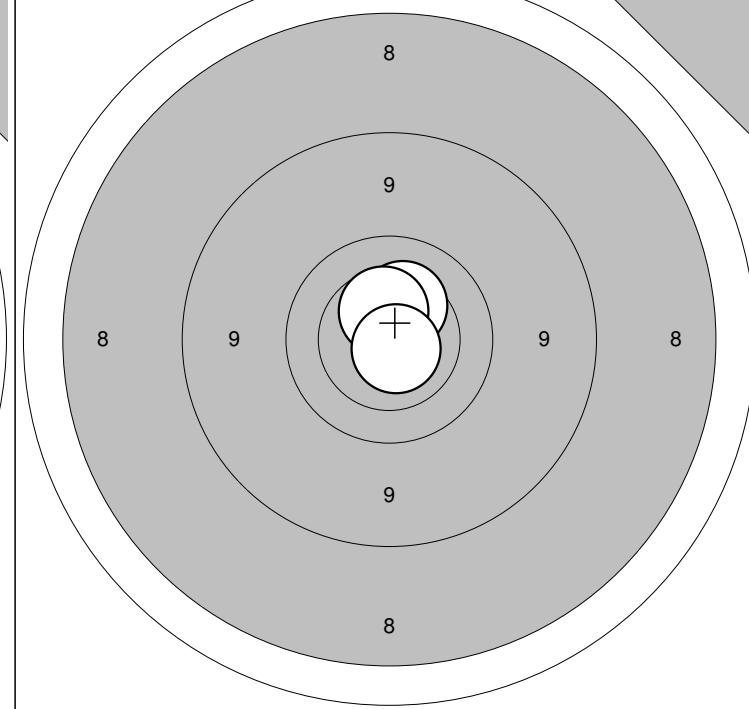

1: 9,7 ↘  
 2: 10,0 ↓  
 3: 10,8\* ↘  
 4: 10,8\* ↓  
 5: 10,2 ↗

6: 10,1 ←  
 7: 10,2 ←  
 8: 10,3 ↘  
 9: 10,2 ←  
 10: 10,2 ↗

Serie: 99,0  
 Sum: 0,0

11: 10,3 ↗  
 12: 10,5 ↑  
 13: 10,7\* ↘

Serie: 30,0  
 Sum: 0,0

Gældende

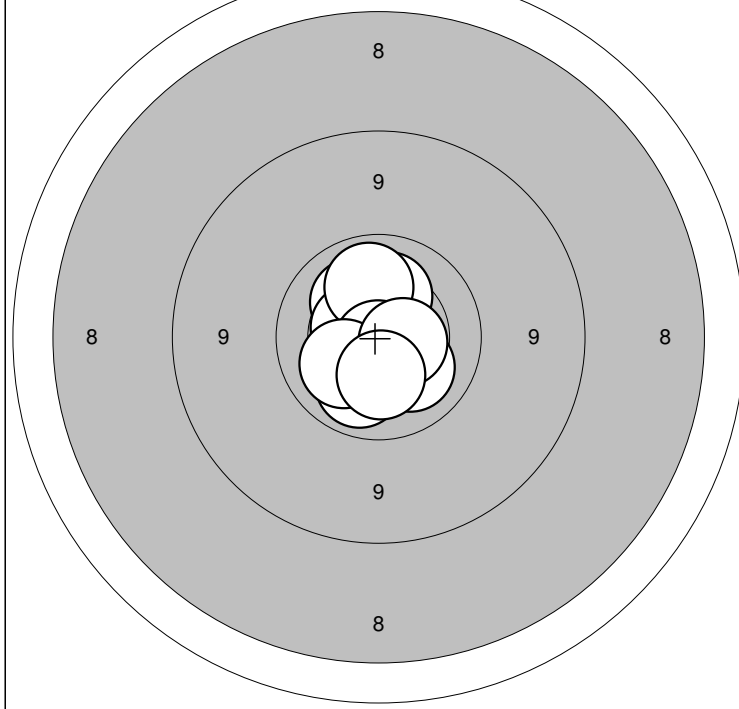

Gældende

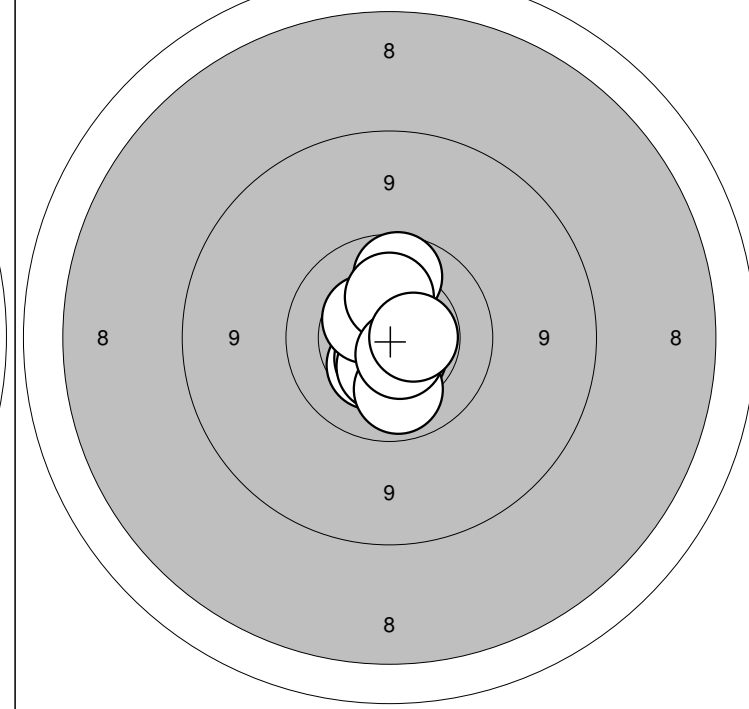

1: 10,2 ↗  
 2: 10,2 ↑  
 3: 10,5\* ↖  
 4: 10,1 ↘  
 5: 10,1 ↑

6: 10,8\* ↓  
 7: 10,2 ↘  
 8: 10,2 ↖  
 9: 10,5\* →  
 10: 10,3 ↓

Serie: 100,0  
 Sum: 100,0

11: 10,4 ↘  
 12: 10,6\* ↘  
 13: 10,4 ↘  
 14: 9,9 ↑  
 15: 10,5 ↗

16: 10,6\* ↘  
 17: 10,3 ↑  
 18: 10,1 ↘  
 19: 10,6\* ↘  
 20: 10,5\* →

Serie: 99,0  
 Sum: 199,0

Hold  
**48**

Bane  
**1**

# Casper Kunuunnguaq Kreutzmann

Ulsted Skf.

BK3

Jyllandsstævne 2011 - riffel

Aalborg Skyttekreds

## Prøveskud

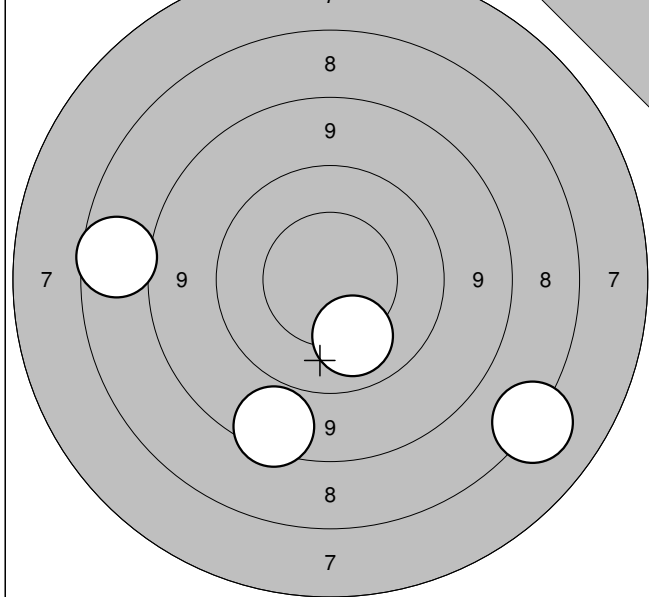

1:	7,4	↘
2:	7,9	←
3:	10,1	↘
4:	8,7	↘

Serie:	32,0
Sum:	0,0

## Gældende

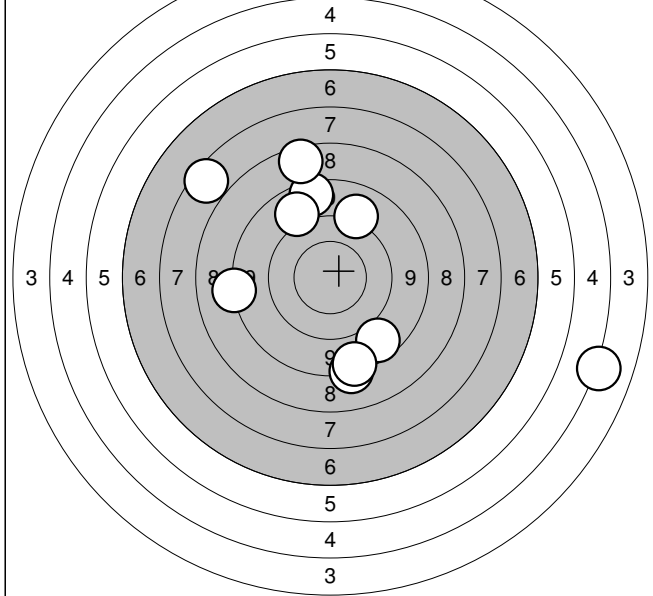

1:	9,2	↑
2:	8,4	←
3:	8,9	↘
4:	6,7	↗
5:	8,4	↘
6:	8,7	↑
7:	9,1	↗
8:	3,3	→
9:	7,8	↑
10:	8,6	↘

Serie:	74,0
Sum:	74,0

## Gældende

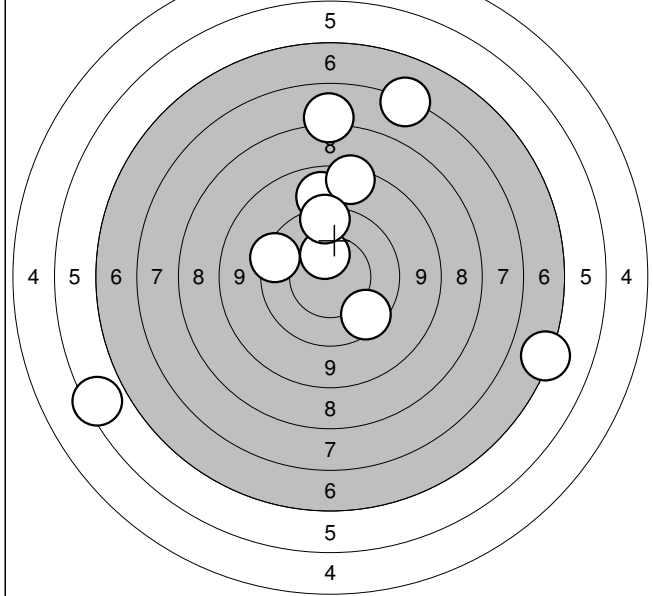

11:	9,1	↑
12:	7,2	↑
13:	6,4	↗
14:	10,5	↑
15:	5,5	→
16:	8,7	↑
17:	4,7	←
18:	9,6	↑
19:	9,6	←
20:	9,8	↘

Serie:	76,0
Sum:	150,0

Jyllandsstævne 2011



Hold  
**48**Bane  
**2****Charlotte Larsen**

Vilsted Skf.

ÅK2

Jyllandsstævne 2011 - riffel

Aalborg Skyttekreds

Prøveskud

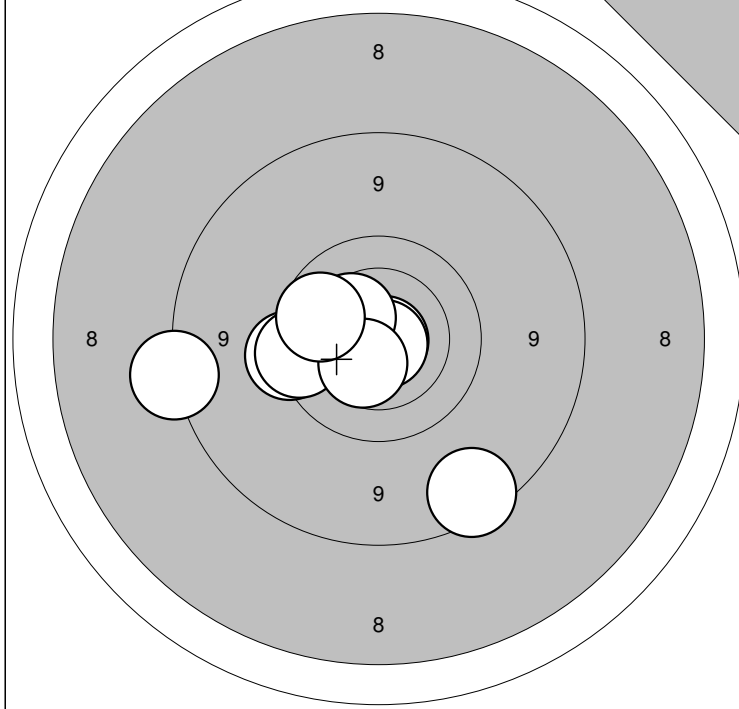

Prøveskud

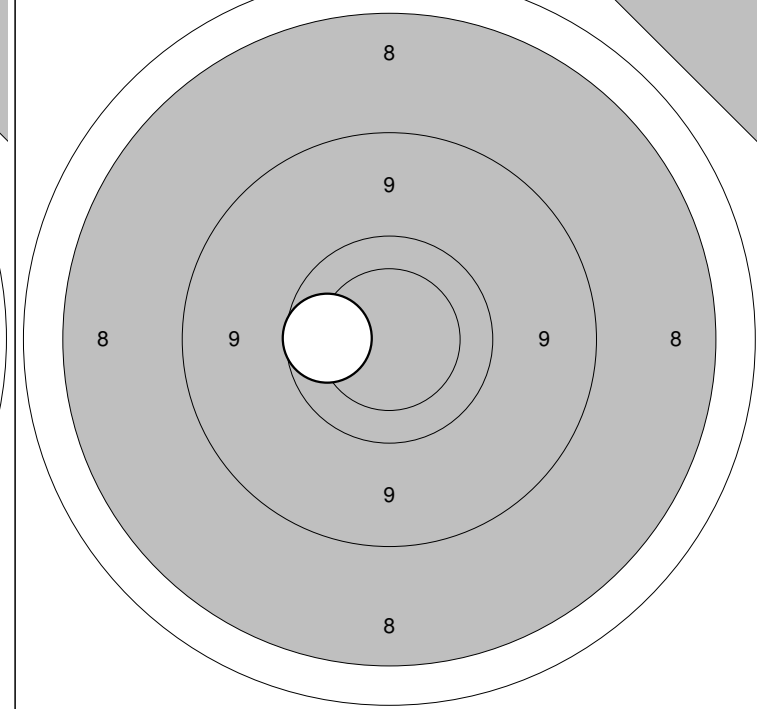

1: 8,8 ↘	6: 8,7 ←
2: 10,8* →	7: 9,7 ←
3: 9,6 ←	8: 10,4 ↗
4: 9,9 ←	9: 10,5 ↘
5: 10,8* ↘	10: 9,9 ←

Serie:	92,0
Sum:	0,0

11: 9,9 ←

Serie:	9,0
Sum:	0,0

Gældende

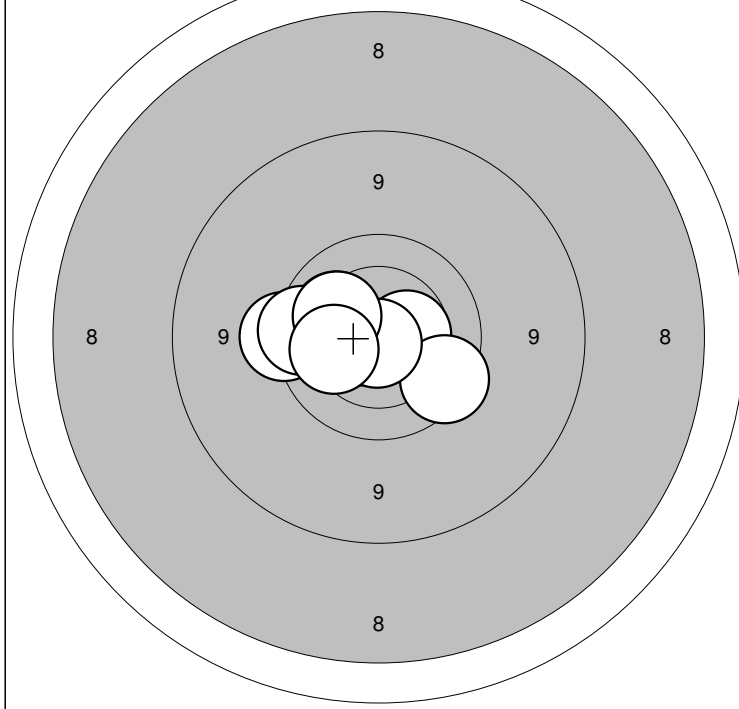

Gældende

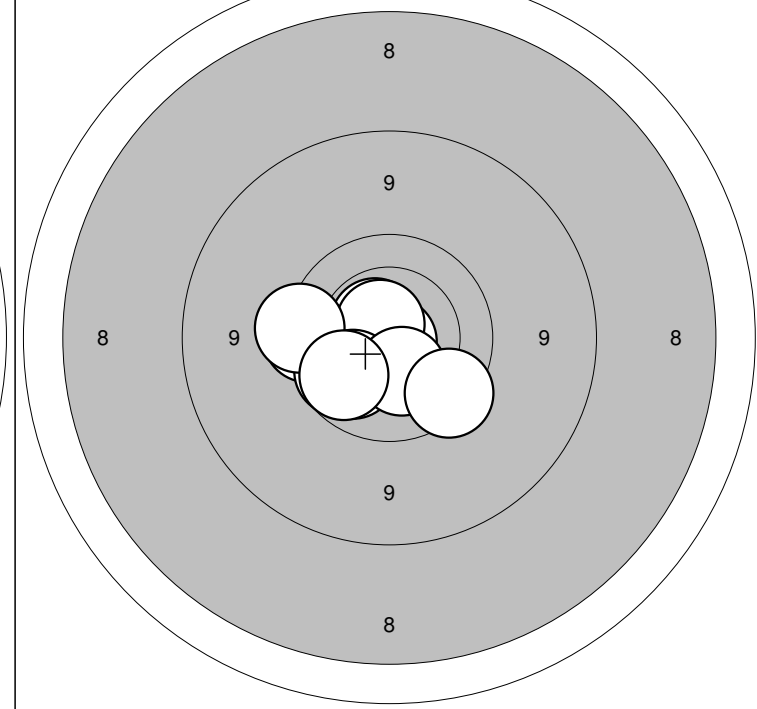

1: 10,5 →	6: 9,6 ←
2: 10,3 ←	7: 10,8* ↓
3: 10,2 ↗	8: 9,8 ←
4: 9,8 ↘	9: 10,2 ↖
5: 10,6* ←	10: 10,2 ←

Serie:	97,0
Sum:	97,0

11: 10,9* ↘	16: 9,7 ←
12: 10,6* ↗	17: 10,1 ↘
13: 9,7 ←	18: 10,3 ↓
14: 9,9 ↖	19: 10,0 ↖
15: 10,7* ↗	20: 9,7 ↘

Serie:	96,0
Sum:	193,0

Jyllandsstævne 2011

Hold

48

Bane

3

Morten Aagaard Christensen

Vilsted Skf.

ÅK2

Jyllandsstævne 2011 - riffel

Aalborg Skyttekreds

Prøveskud

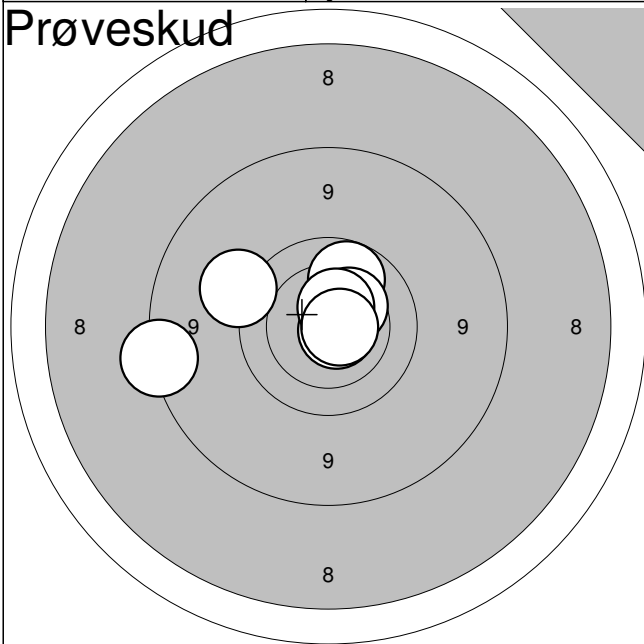

1: 8,7

←

2: 9,4

↖

3: 10,8\*

→

4: 10,0

↑

5: 10,4

↗

6: 10,5\*

↑

7: 10,7\*

→

Serie:

67,0

Sum:

0,0

Gældende

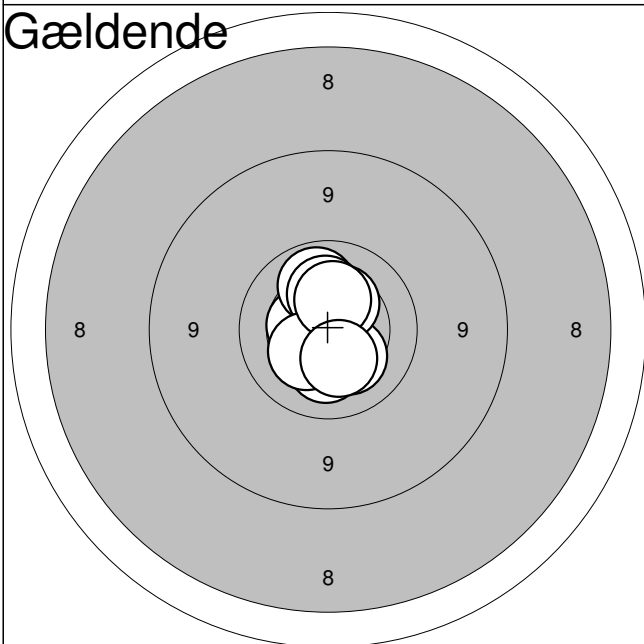

1: 10,9\*

→

2: 10,3

↘

3: 10,3

↓

4: 10,5\*

←

5: 10,4

↗

6: 10,1

↑

7: 10,3

↑

8: 10,3

↙

9: 10,4

↑

10: 10,3

↓

Serie:

100,0

Sum:

100,0

Gældende

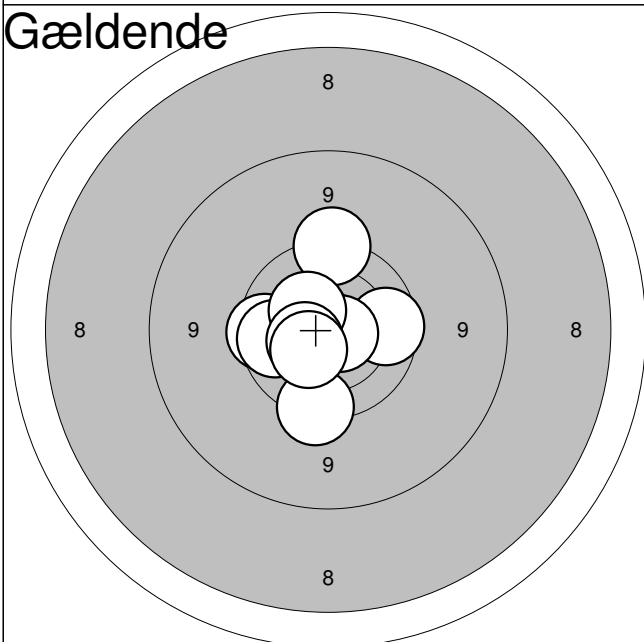

11: 9,6

↑

12: 9,8

←

13: 9,9

→

14: 9,6

↓

15: 10,7\*

↗

16: 9,9

←

17: 10,7\*

→

18: 10,4

↗

19: 10,4

↖

20: 10,4

↙

Serie:

95,0

Sum:

195,0

Jyllandsstævne 2011

Hold

48

Bane

4

Rasmus Brasch

Midtdjurs Skytteforening

BK1

Jyllandsstævne 2011 - riffel

Aalborg Skyttekreds

Prøveskud

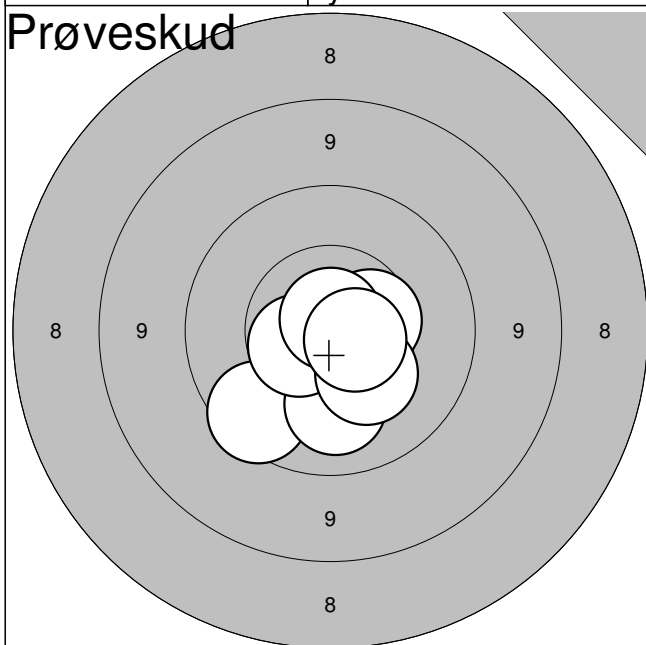

1: 10,7\*  
 2: 10,9\*  
 3: 10,6\*  
 4: 10,5  
 5: 9,8  
 6: 10,2  
 7: 10,6  
 8: 10,4  
 9: 10,8\*  
 10: 10,7\*

↓  
 ↓  
 ↙  
 →  
 ↘  
 ↓  
 ↙  
 ↓  
 ↘  
 ↗

Serie: 99,0

Sum: 0,0

Gældende

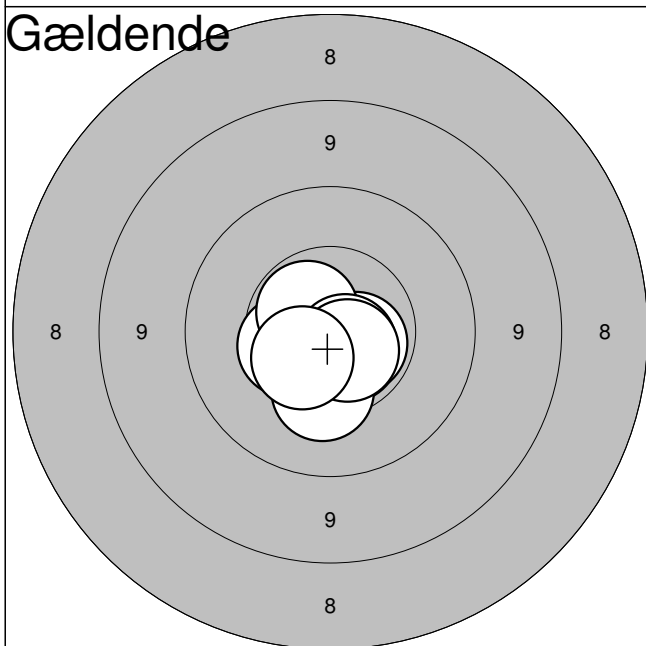

1: 10,7\*  
 2: 10,7\*  
 3: 10,3  
 4: 10,6\*  
 5: 10,8\*  
 6: 10,5  
 7: 10,6\*  
 8: 10,7\*  
 9: 10,7\*  
 10: 10,5

↘  
 ↘  
 ↓  
 →  
 ↘  
 ↙  
 ↗  
 ↘  
 ↓  
 ↘

Serie: 100,0

Sum: 100,0

Gældende

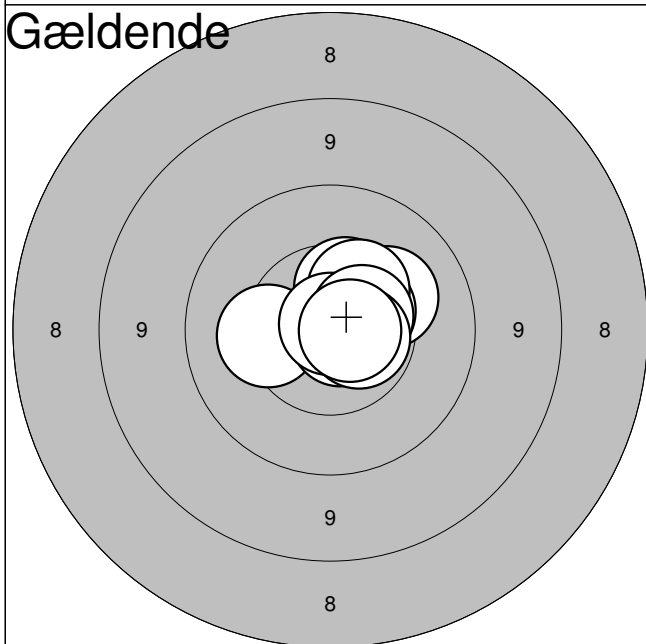

11: 10,3  
 12: 10,3  
 13: 10,8\*  
 14: 10,5  
 15: 10,5  
 16: 10,4  
 17: 10,9\*  
 18: 10,6  
 19: 10,6\*  
 20: 10,7\*

←  
 ↗  
 ↘  
 ↗  
 ↑  
 ↗  
 ↑  
 →  
 →  
 →

Serie: 100,0

Sum: 200,0

Jyllandsstævne 2011

Hold  
**48**Bane  
**5****Jonas Martinsen**

Midtdjurs Skytteforening

BK2

Jyllandsstævne 2011 - riffel

Aalborg Skyttekreds

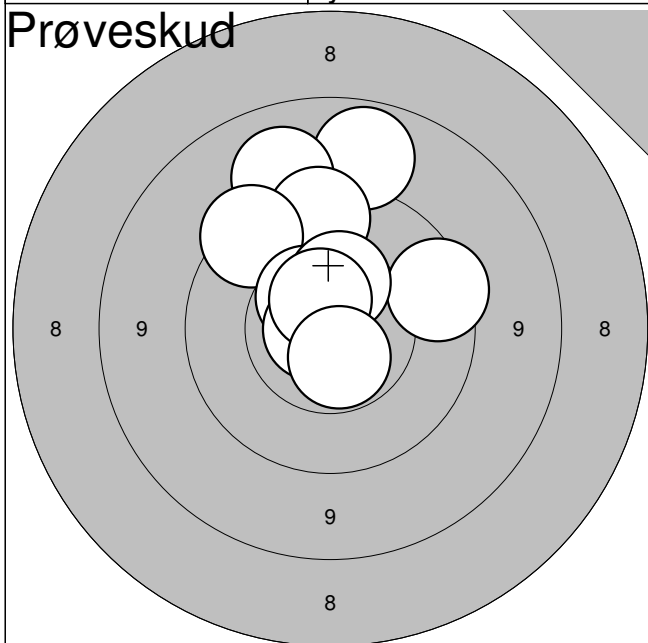
**Prøveskud**

1:	9,0	↑
2:	9,2	↑
3:	9,8	↑
4:	9,6	↗
5:	10,5	↗
6:	9,7	→
7:	10,5	↑
8:	10,8*	←
9:	10,6*	↑
10:	10,6*	↓

Serie: 95,0

Sum: 0,0

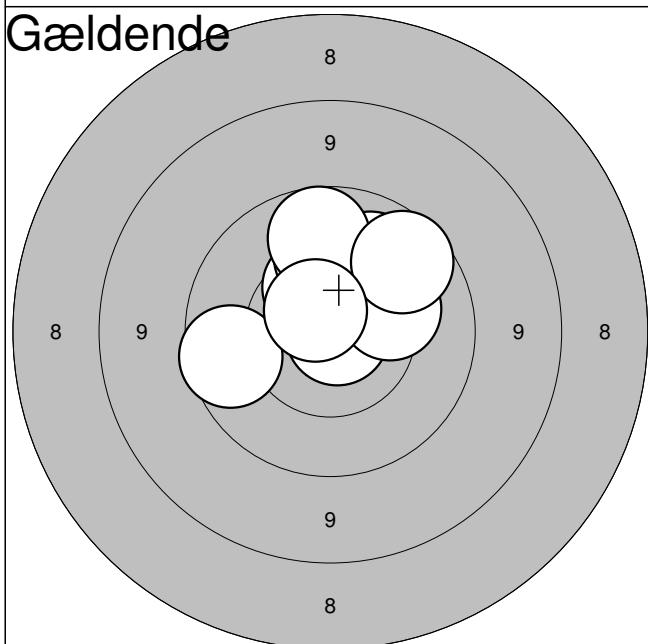
**Gældende**

1:	10,5	↑
2:	10,9*	→
3:	10,1	↗
4:	10,2	↑
5:	10,1	↗
6:	10,0	↑
7:	10,3	→
8:	9,9	↗
9:	9,9	←
10:	10,7*	↗

Serie: 98,0

Sum: 98,0

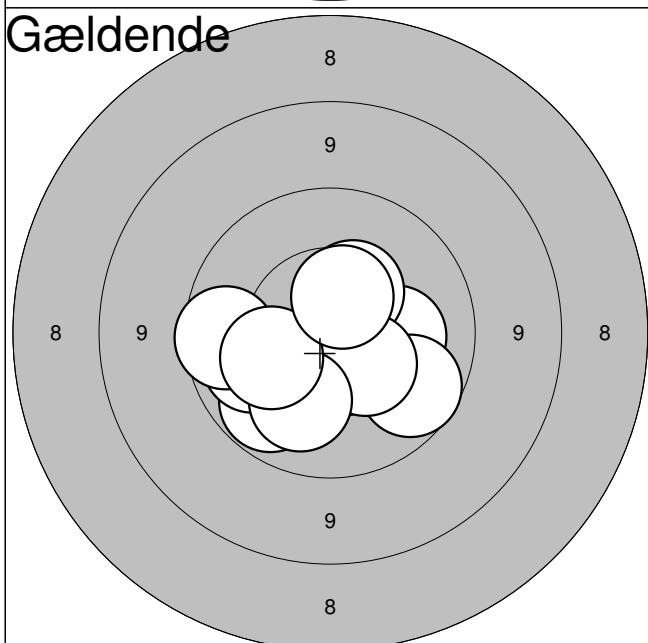
**Gældende**

11:	10,3	→
12:	10,5	↗
13:	10,0	↓
14:	10,1	←
15:	9,9	↓
16:	10,4	↓
17:	9,8	←
18:	10,2	↓
19:	10,3	←
20:	10,6	↑

Serie: 98,0

Sum: 196,0

Jyllandsstævne 2011

Hold  
**48**Bane  
**7****Jonas Engberg Hansen**

Vilsted Skf.

BK2

Jyllandsstævne 2011 - riffel

Aalborg Skyttekreds

Prøveskud

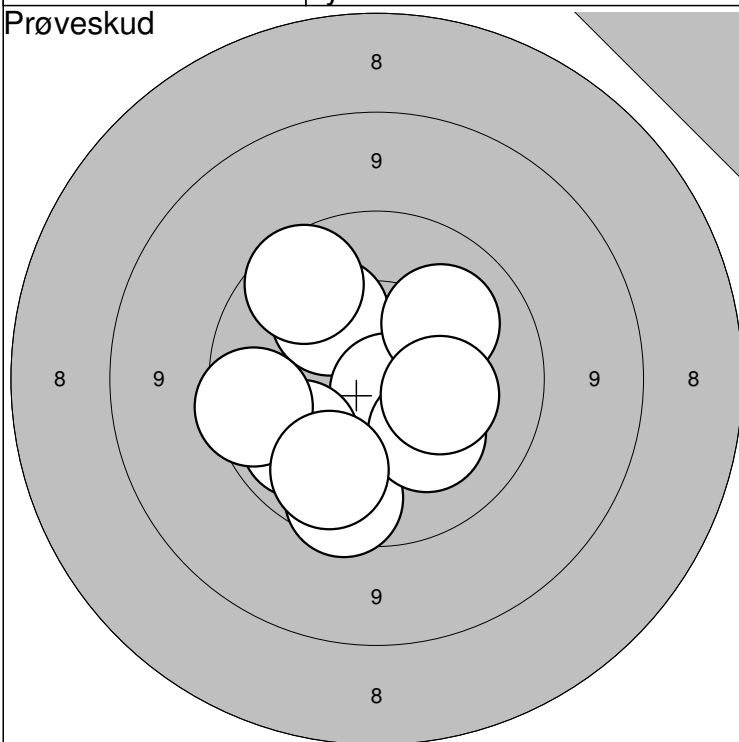

Prøveskud

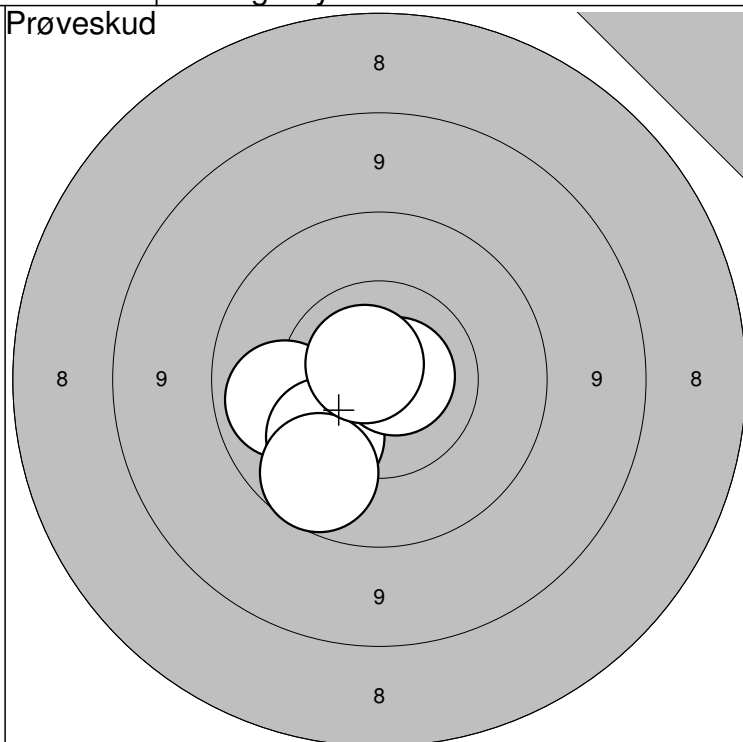

1:10,2 ↗  
2:10,8\* ↘  
3:10,1 ↙  
4: 9,9 ↖  
5: 9,8 ↓

6: 9,8 ←  
7:10,3 ↘  
8:10,0 ↓  
9:10,2 ↗  
10:10,3 →

Serie: 97,0

Sum: 0,0

11:10,1 ←  
12:10,2 ↘  
13:10,8\* →  
14: 9,9 ↘  
15:10,8\* ↖

Serie: 49,0

Sum: 0,0

Gældende

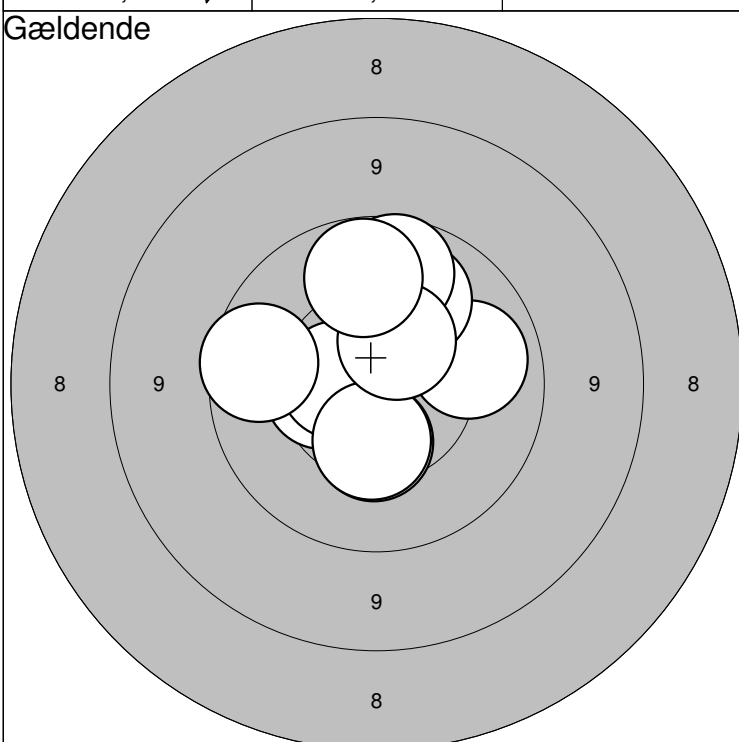

Gældende

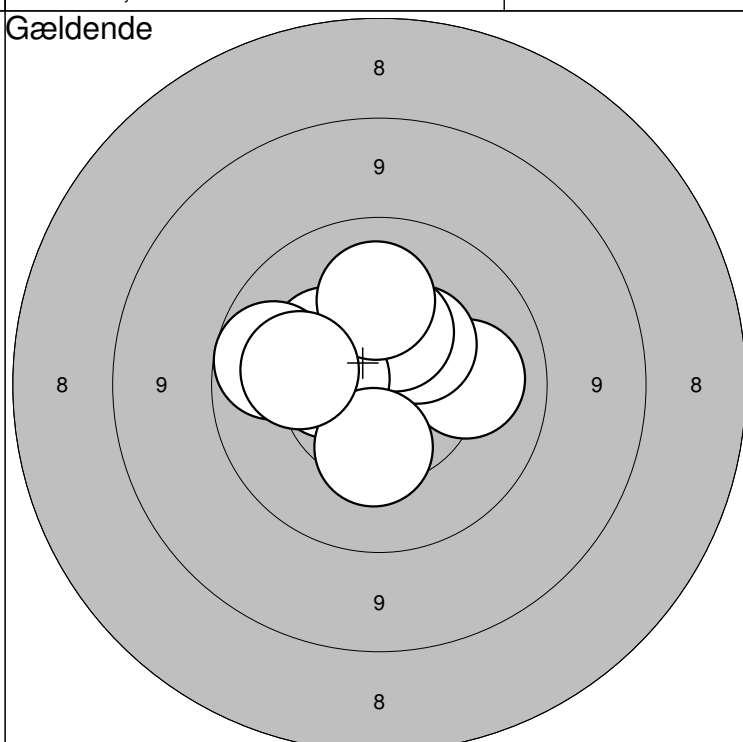

1:10,5 ←  
2:10,6\* ←  
3:10,1 →  
4:10,1 ↗  
5:10,4 ↓

6:10,4 ↓  
7: 9,9 ↗  
8: 9,8 ←  
9:10,5 ↗  
10:10,0 ↗

Serie: 98,0

Sum: 98,0

11:10,7\* ↖  
12:10,2 →  
13:10,4 ↗  
14:10,4 ↖  
15:10,5 ↗

16:10,0 ←  
17:10,5 ←  
18:10,4 ↓  
19:10,2 ↗  
20:10,2 ←

Serie: 100,0

Sum: 198,0

Jyllandsstævne 2011

Hold  
**48**Bane  
**8****Kristine Rasmussen**

Ulsted Skf.

ÅK1

Jyllandsstævne 2011 - riffel

Aalborg Skyttekreds

Prøveskud

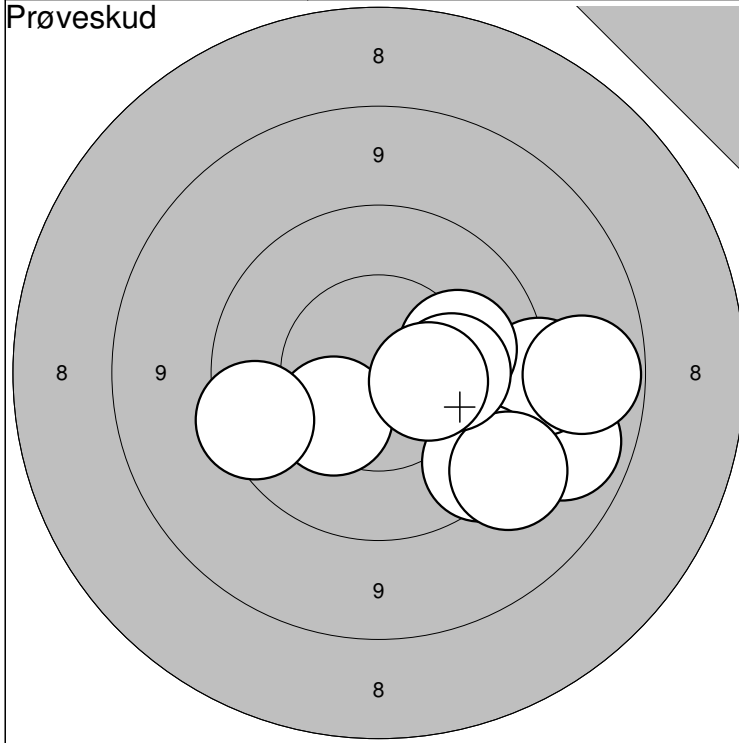

Prøveskud

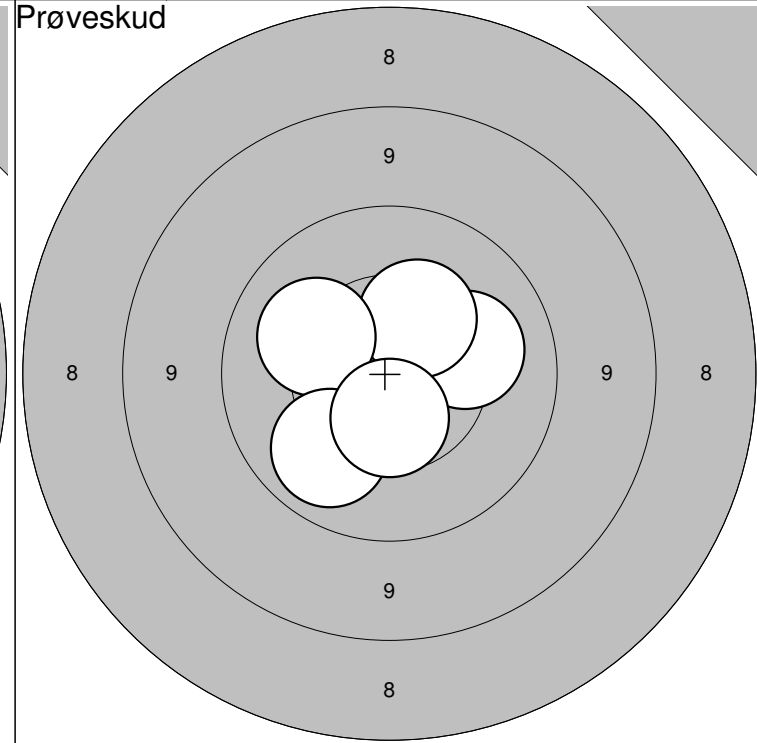

1: 9,1 →	6:10,4 ↙	Serie: 94,0
2: 9,4 →	7: 9,7 ↙	
3: 9,0 →	8:10,2 →	Sum: 0,0
4: 9,7 ↘	9:10,3 →	
5: 9,4 ↘	10:10,5 →	

11:10,2 →	Serie: 50,0
12:10,4 ↗	
13:10,2 ↖	Sum: 0,0
14:10,1 ↘	
15:10,5 ↓	

Gældende

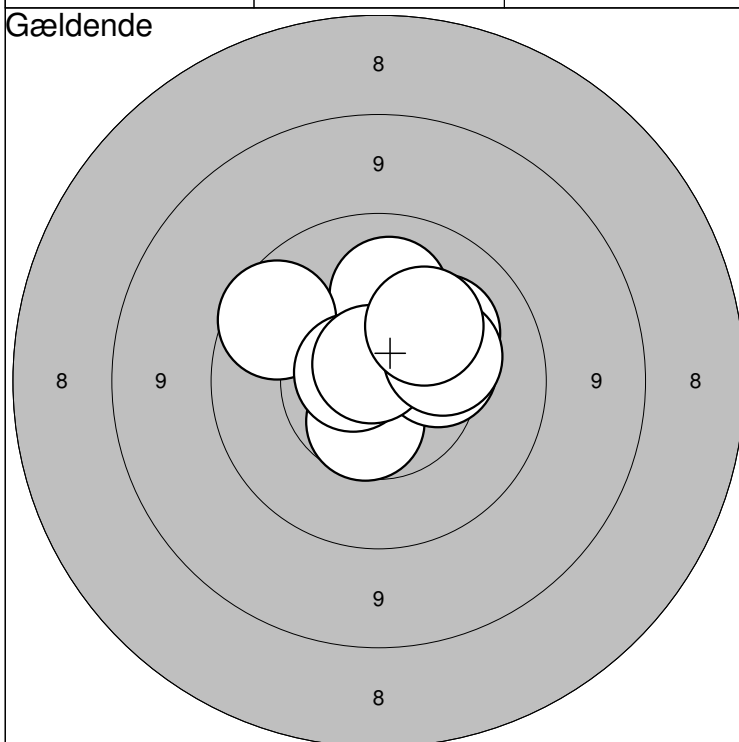

Gældende

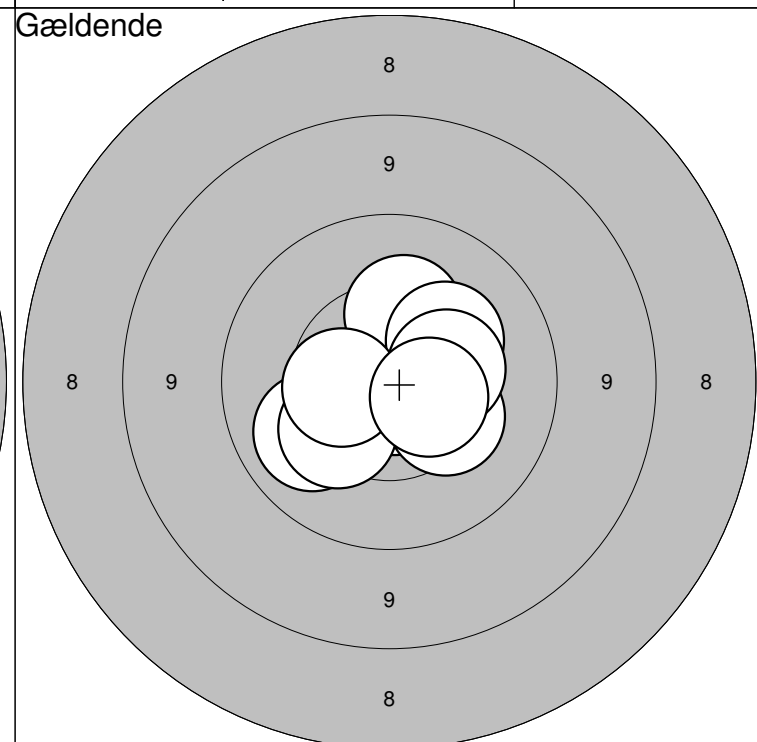

1:10,2 ↑	6:10,4 →	Serie: 99,0
2: 9,9 ↖	7:10,2 ↗	
3:10,7* ↗	8:10,8* ↗	Sum: 99,0
4:10,6 ↓	9:10,3 →	
5:10,7* ↖	10:10,3 ↗	

11:10,5 →	16:10,1 ↖	Serie: 100,0
12:10,8* ↓	17:10,3 ↖	
13:10,3 ↘	18:10,5 ↖	Sum: 199,0
14:10,3 ↑	19:10,4 →	
15:10,3 ↗	20:10,6 →	

Jyllandsstævne 2011

Hold

48

Bane

9

## Cecile Severin Ingvarlsen

Mou &amp; Omegns Skf.

BK4

Jyllandsstævne 2011 - riffel

Aalborg Skyttekreds

## Prøveskud

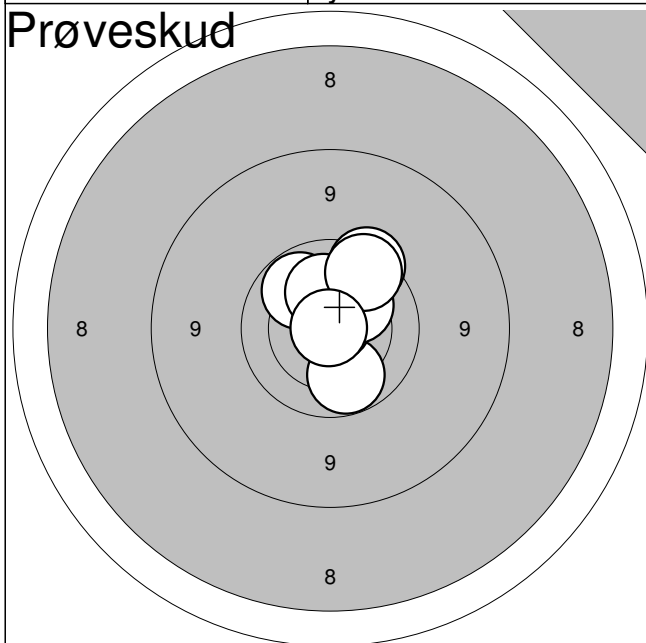

1:	10,0	↓
2:	10,8*	↗
3:	9,7	↗
4:	10,3	↗
5:	10,0	↗
6:	10,2	↑
7:	9,8	↗
8:	10,9*	←

Serie: 78,0

Sum: 0,0

## Gældende

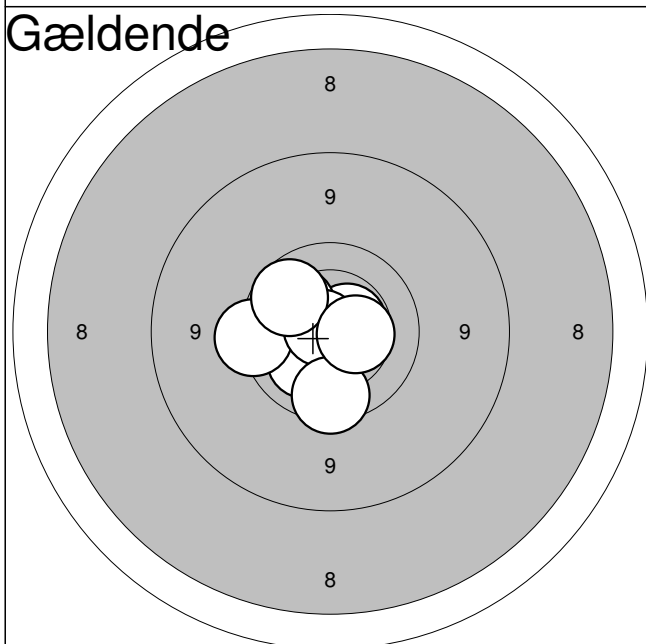

1:	10,4	↙
2:	10,4	↙
3:	10,2	↙
4:	10,6*	↗
5:	10,1	↗
6:	9,7	←
7:	10,8*	↖
8:	9,8	↓
9:	9,9	↗
10:	10,4	→

Serie: 97,0

Sum: 97,0

## Gældende

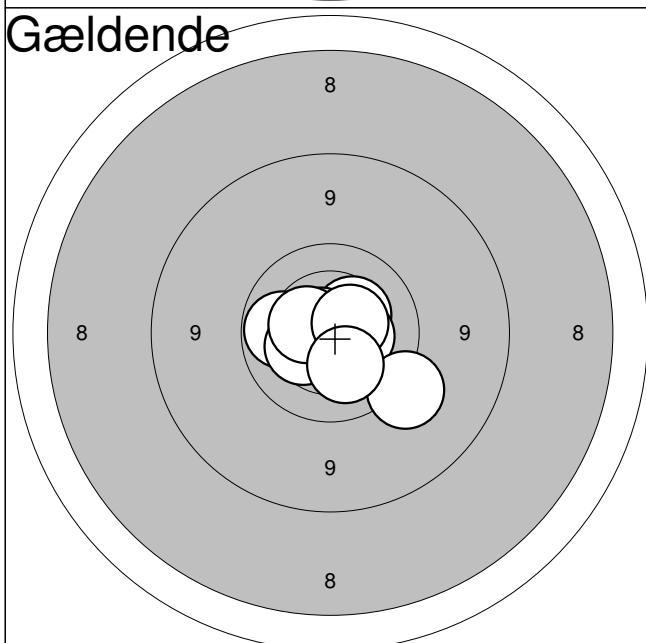

11:	10,9*	↗
12:	10,4	↗
13:	10,7*	↗
14:	10,4	→
15:	10,0	←
16:	9,5	↙
17:	10,4	←
18:	10,5	←
19:	10,5*	↗
20:	10,3	↓

Serie: 99,0

Sum: 196,0

Jyllandsstævne 2011

Hold

48

Bane

10

## Simone Severin Ingvarlsen

Mou &amp; Omegns Skf.

BK3

Jyllandsstævne 2011 - riffel

Aalborg Skyttekreds

## Prøveskud

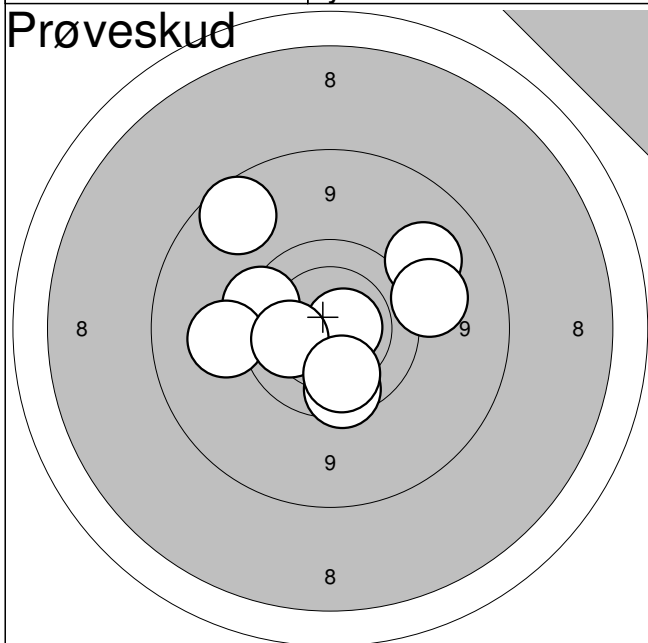

1:	8,9	↗
2:	9,2	↗
3:	9,8	↓
4:	9,4	→
5:	9,7	←
6:	9,4	←
7:	10,7*	→
8:	10,1	←
9:	10,0	↓

Serie: 83,0

Sum: 0,0

## Gældende

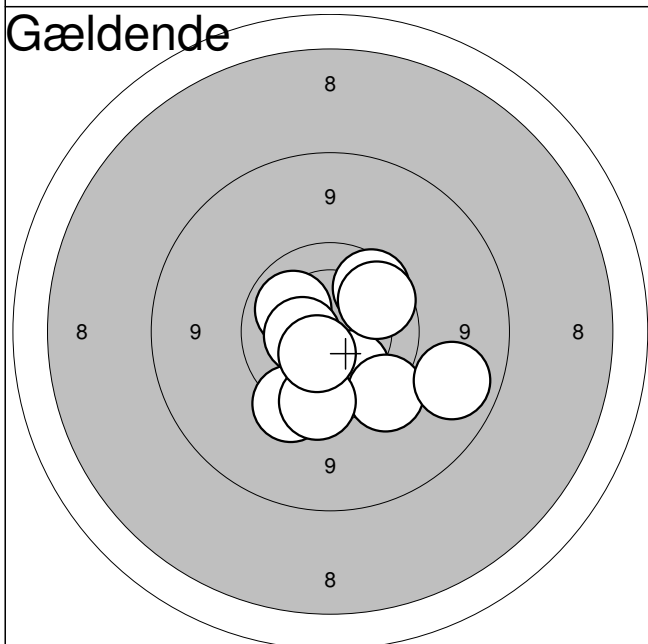

1:	9,6	↓
2:	10,1	↗
3:	10,1	↓
4:	9,6	↓
5:	9,7	↓
6:	10,4	←
7:	9,1	→
8:	9,9	↗
9:	10,4	↓
10:	9,9	↗

Serie: 94,0

Sum: 94,0

## Gældende

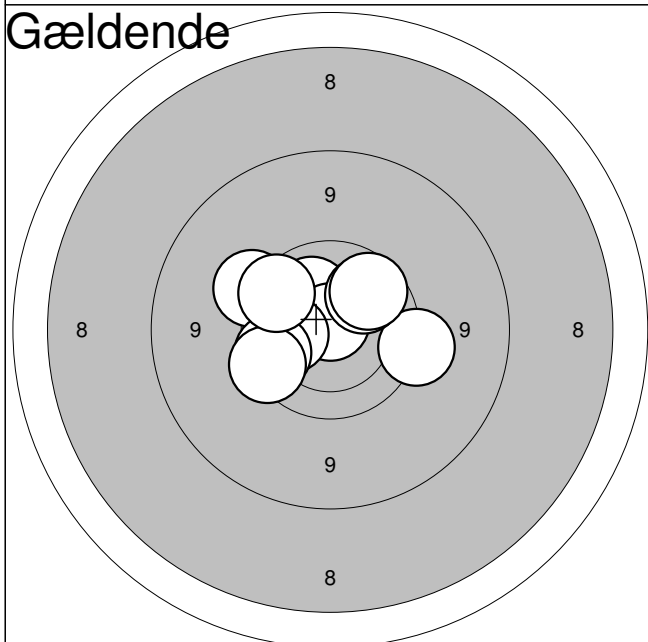

11:	9,5	→
12:	10,2	↗
13:	9,5	↖
14:	10,8*	↑
15:	10,0	↗
16:	10,2	←
17:	9,9	↗
18:	9,8	←
19:	9,7	↖
20:	9,8	↖

Serie: 94,0

Sum: 188,0

Jyllandsstævne 2011



Hold

48

Bane

11

Ruth Thorius

Vilsted Skf.

ÅK3

Jyllandsstævne 2011 - riffel

Aalborg Skyttekreds

Prøveskud

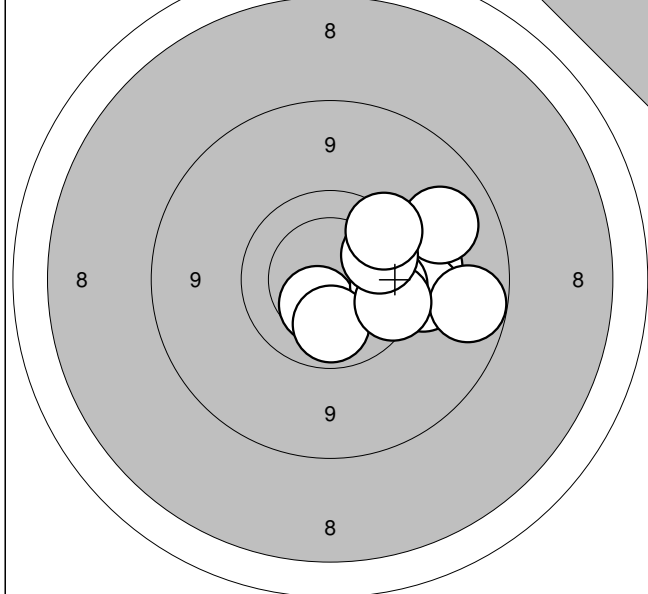

1:	9,5	→
2:	9,5	→
3:	10,4	↓
4:	9,0	→
5:	9,9	→
6:	10,1	↓
7:	9,2	→
8:	9,8	→
9:	9,9	→
10:	9,7	↗

Serie: 92,0

Sum: 0,0

Gældende

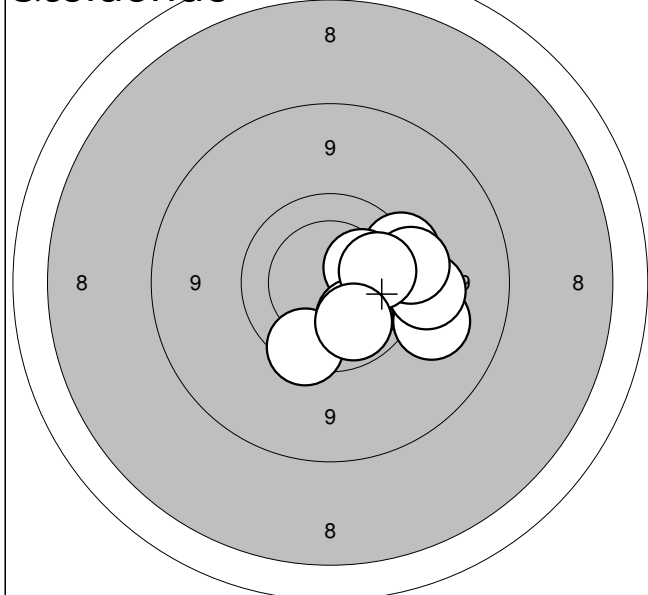

1:	9,7	→
2:	9,8	→
3:	9,7	↓
4:	10,3	→
5:	9,3	→
6:	9,4	→
7:	9,6	→
8:	10,1	↓
9:	10,0	→
10:	10,0	↓

Serie: 94,0

Sum: 94,0

Gældende

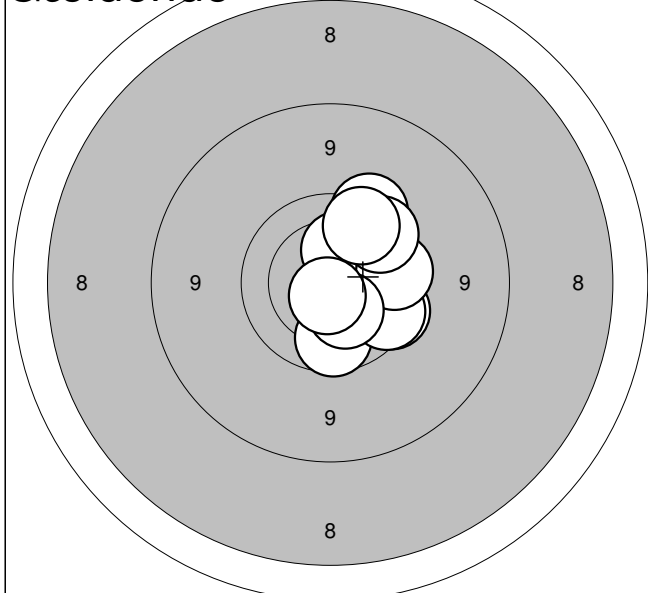

11:	9,8	↘
12:	9,9	↓
13:	9,8	↘
14:	10,3	↑
15:	9,6	↗
16:	9,8	→
17:	10,3	↓
18:	9,7	↗
19:	9,8	↗
20:	10,7*	↓

Serie: 93,0

Sum: 187,0

Jyllandsstævne 2011

Hold  
**48**

Bane  
**12**

# Anita Fragtrup

Vilsted Skf.

ÅK2

Jyllandsstævne 2011 - riffel

Aalborg Skyttekreds

Prøveskud

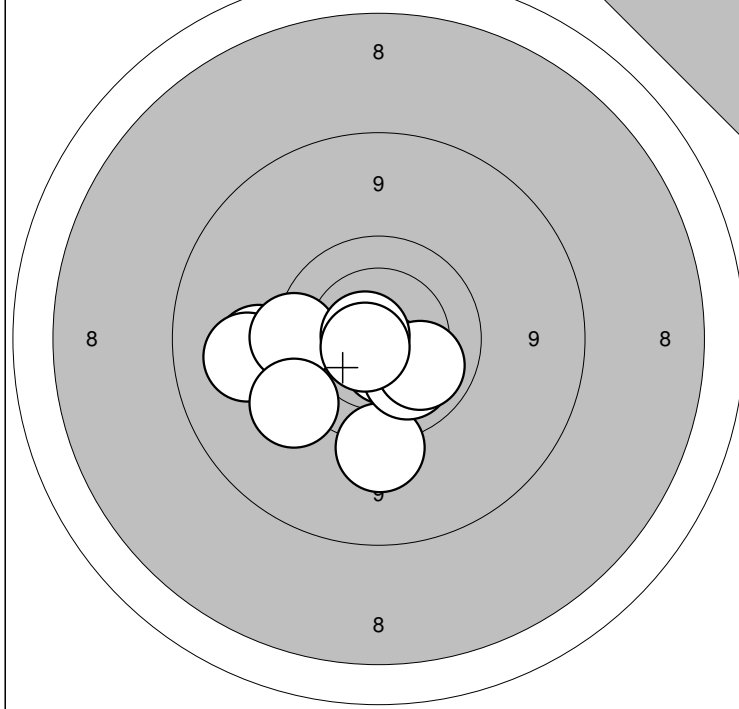

Prøveskud

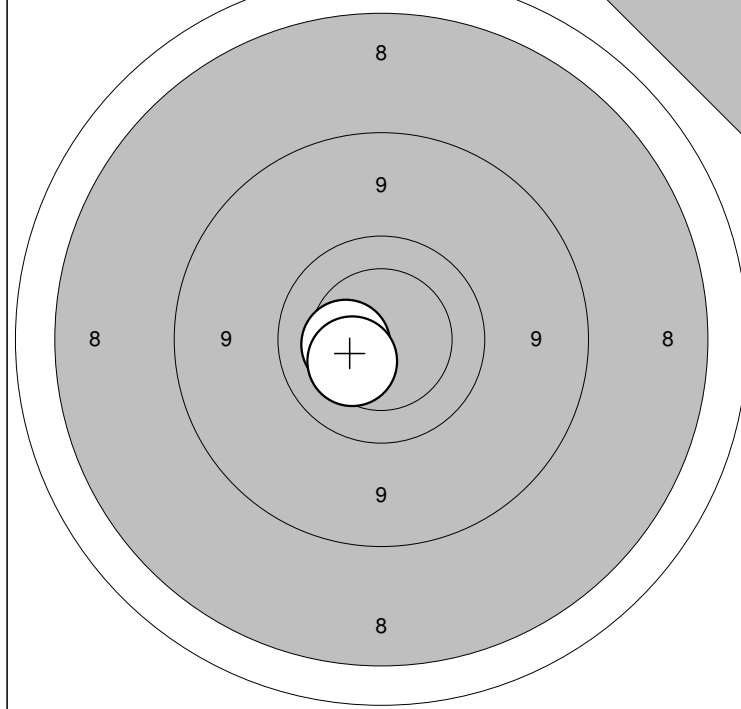

1: 9,5	↓	6: 9,5	↙
2: 10,6*	↓	7: 10,2	↘
3: 9,4	←	8: 10,1	↘
4: 9,2	←	9: 10,7*	←
5: 9,7	←	10: 10,7*	↙

Serie:	95,0
Sum:	0,0

11: 10,3	←
12: 10,3	↙

Serie:	20,0
Sum:	0,0

Gældende

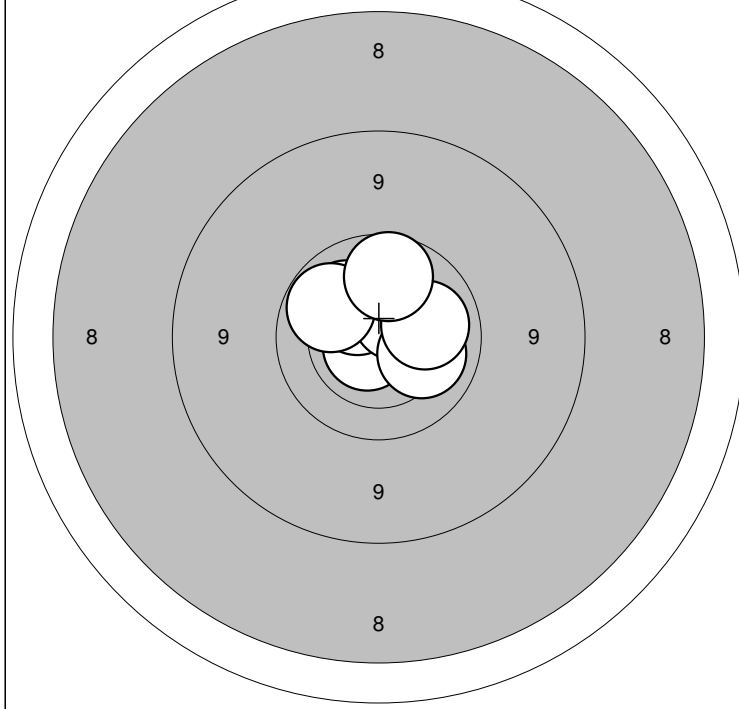

Gældende

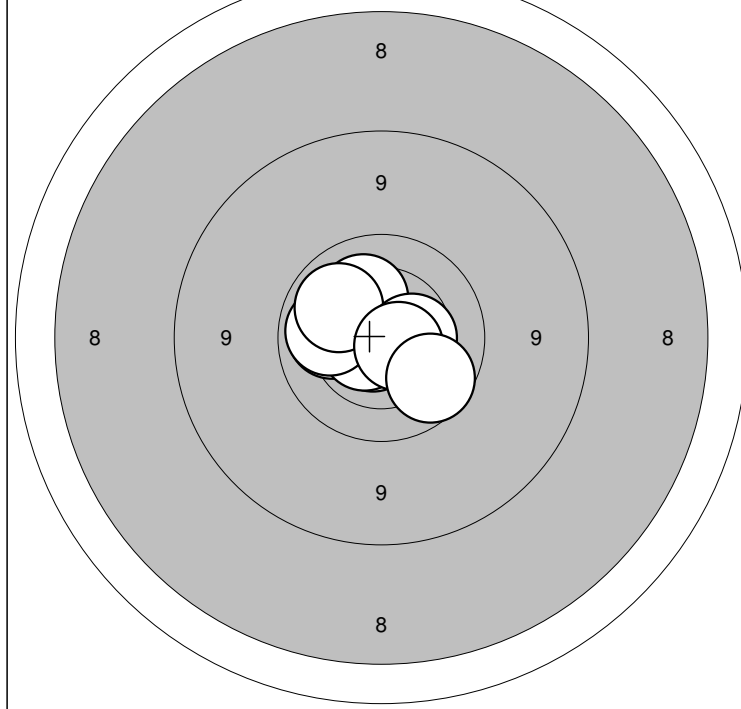

1: 10,3	↗	6: 10,5	↗
2: 10,5*	→	7: 10,2	→
3: 10,7*	↙	8: 10,1	→
4: 10,2	↗	9: 10,0	↖
5: 10,4	↗	10: 9,9	↑

Serie:	99,0
Sum:	99,0

11: 10,1	←	16: 10,2	↗
12: 10,7*	↘	17: 10,1	↖
13: 10,2	←	18: 10,4	→
14: 10,6*	↙	19: 10,6*	↘
15: 10,1	←	20: 9,9	↘

Serie:	99,0
Sum:	198,0

Hold  
**49**

Bane  
**1**

# Louise Jensen

Løgstør Skyttelaug

UNG

Jyllandsstævne 2011 - riffel

Aalborg Skyttekreds

Prøveskud

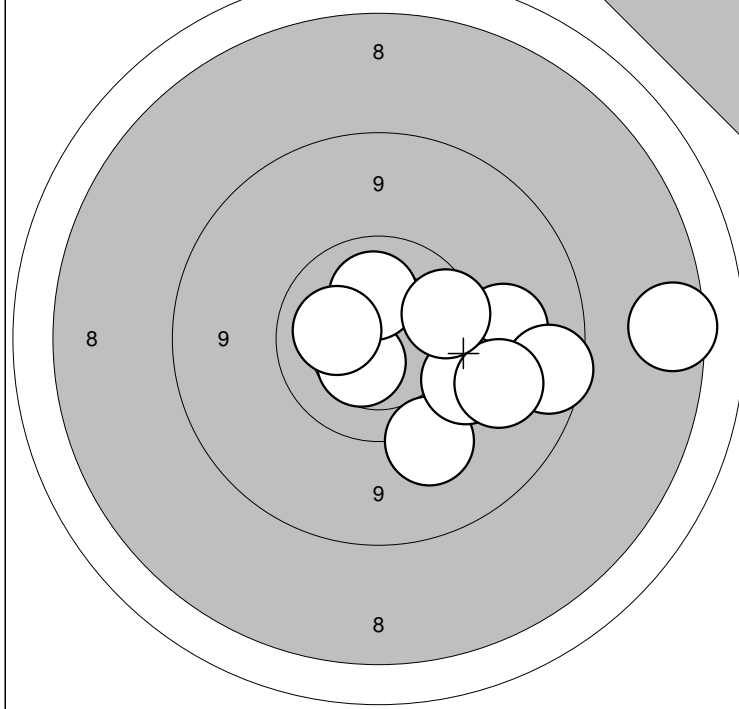

Prøveskud

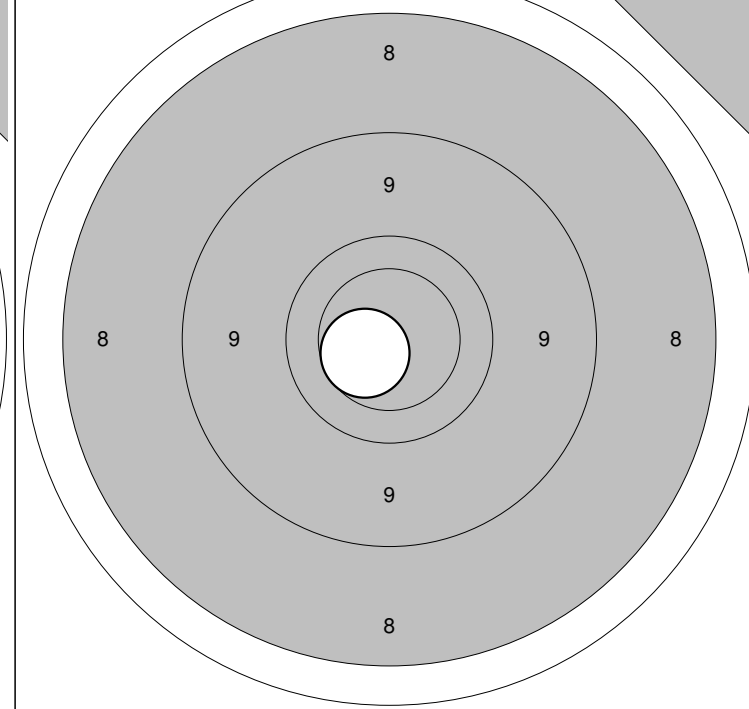

1: 9,3 →  
 2: 9,4 ↓  
 3: 9,6 ↘  
 4: 10,5 ↙  
 5: 10,2 ↑

6: 8,9 →  
 7: 8,1 →  
 8: 9,3 →  
 9: 9,8 →  
 10: 10,2 ←

Serie: 91,0  
 Sum: 0,0

11: 10,5 ←

Serie: 10,0  
 Sum: 0,0

Gældende

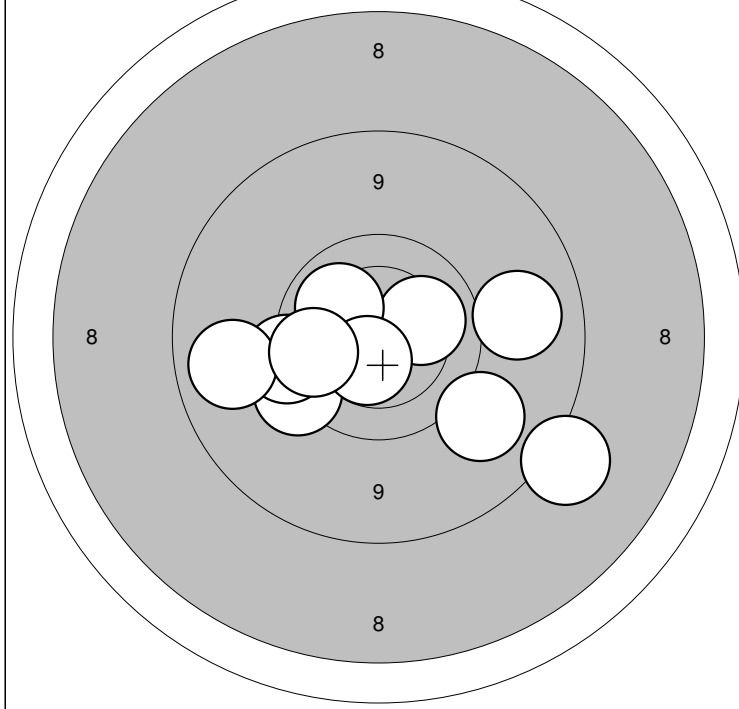

Gældende

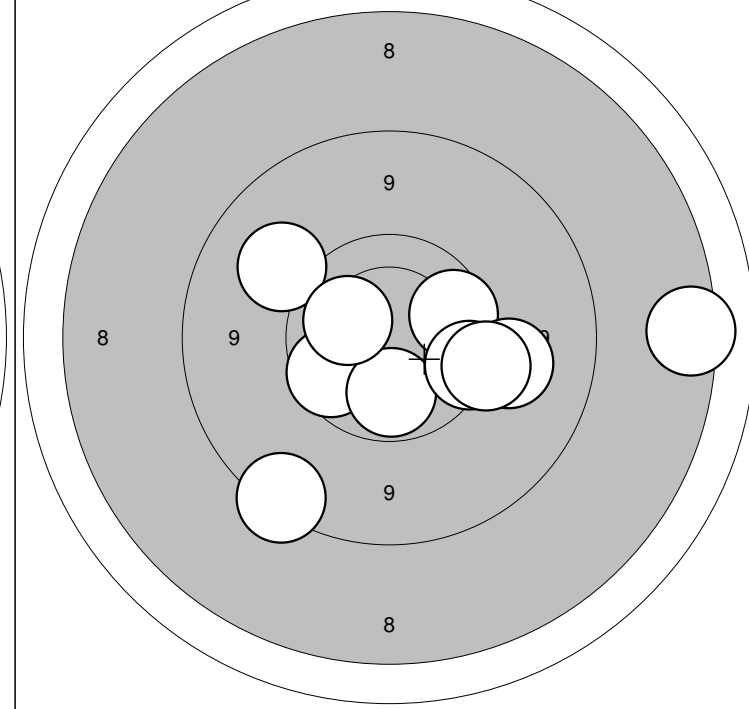

1: 10,2 →  
 2: 10,1 ↖  
 3: 9,6 ↙  
 4: 9,6 ←  
 5: 10,5\* ↓

6: 9,3 ↘  
 7: 9,1 ←  
 8: 9,9 ←  
 9: 9,2 →  
 10: 8,6 ↘

Serie: 92,0  
 Sum: 92,0

11: 9,9 ←  
 12: 8,8 ↓  
 13: 9,9 →  
 14: 9,3 ↖  
 15: 8,1 →

16: 10,0 ↓  
 17: 10,2 ←  
 18: 9,3 →  
 19: 9,7 →  
 20: 9,5 →

Serie: 90,0  
 Sum: 182,0

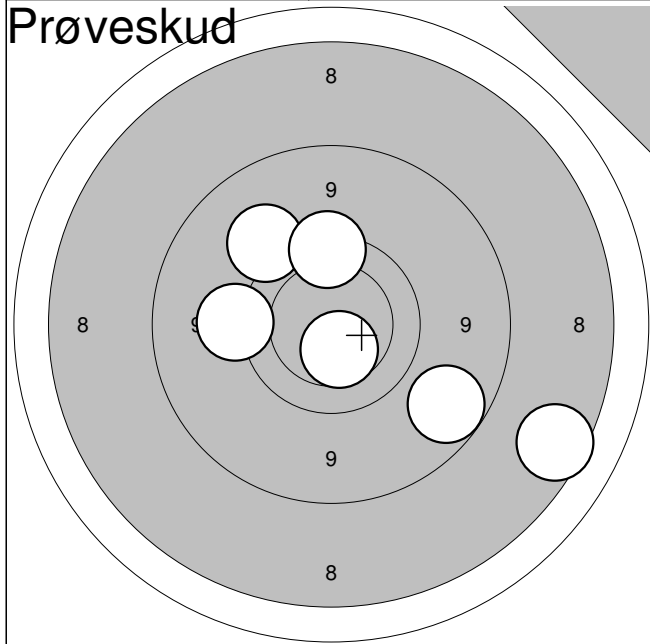

1:	9,4	↗
2:	9,7	↑
3:	9,0	↘
4:	9,5	←
5:	8,1	↘
6:	10,4	↘

<b>Serie:</b>	<b>54,0</b>
<b>Sum:</b>	<b>0,0</b>

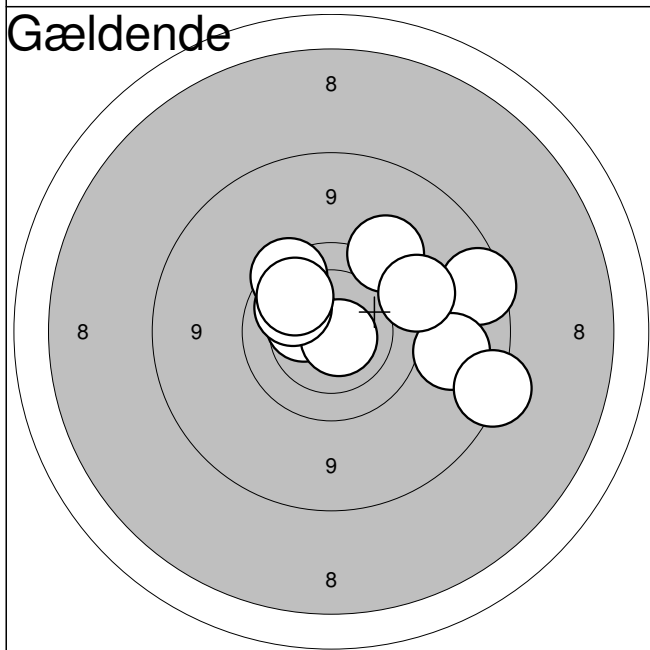

1:	9,7	↗
2:	10,4	←
3:	9,5	↗
4:	10,8*	↘
5:	8,9	→
6:	9,2	→
7:	10,1	↗
8:	9,5	→
9:	8,7	↘
10:	10,0	↗

<b>Serie:</b>	<b>92,0</b>
<b>Sum:</b>	<b>92,0</b>

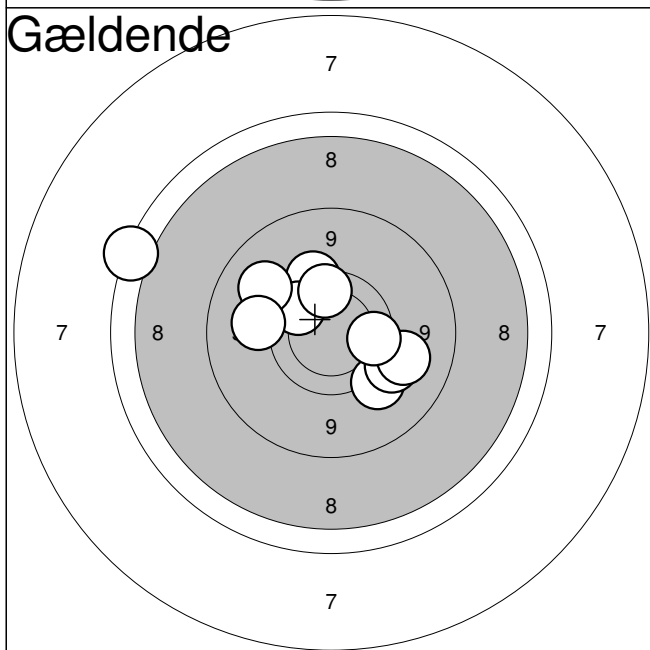

11:	9,6	↗
12:	9,9	↗
13:	9,8	↑
14:	7,7	↗
15:	9,3	↗
16:	9,4	↘
17:	9,4	↘
18:	9,3	↘
19:	9,4	←
20:	9,8	→

<b>Serie:</b>	<b>88,0</b>
<b>Sum:</b>	<b>180,0</b>

Hold  
**49**Bane  
**3****Frits Rasmussen**

Ulsted Skf.

ÅK2

Jyllandsstævne 2011 - riffel

Aalborg Skyttekreds

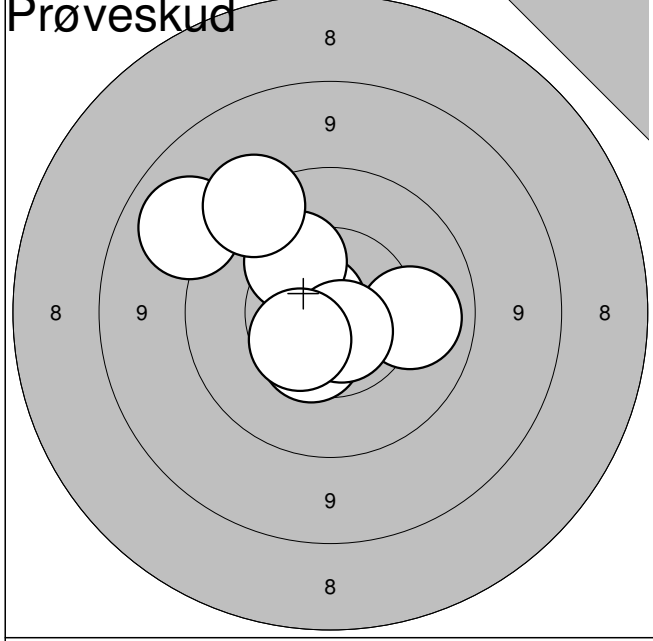
**Prøveskud**

1:	9,1	↖
2:	10,8*	↖
3:	10,3	↗
4:	10,5	↘
5:	9,5	↗
6:	10,1	→
7:	10,7*	↘
8:	10,5	↘

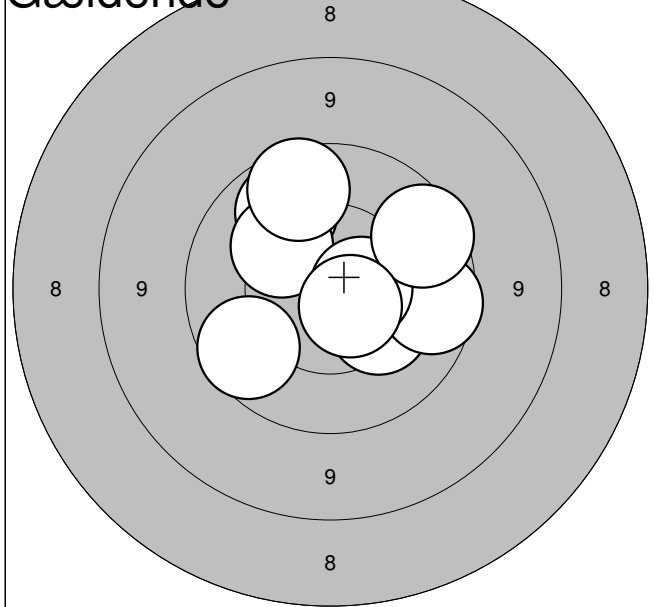
Serie: **78,0**Sum: **0,0****Gældende**

1:	10,0	↗
2:	10,4	↘
3:	10,3	↗
4:	9,8	↗
5:	10,3	↘
6:	9,9	→
7:	9,9	↘
8:	10,6*	→
9:	9,8	↗
10:	10,7*	↘

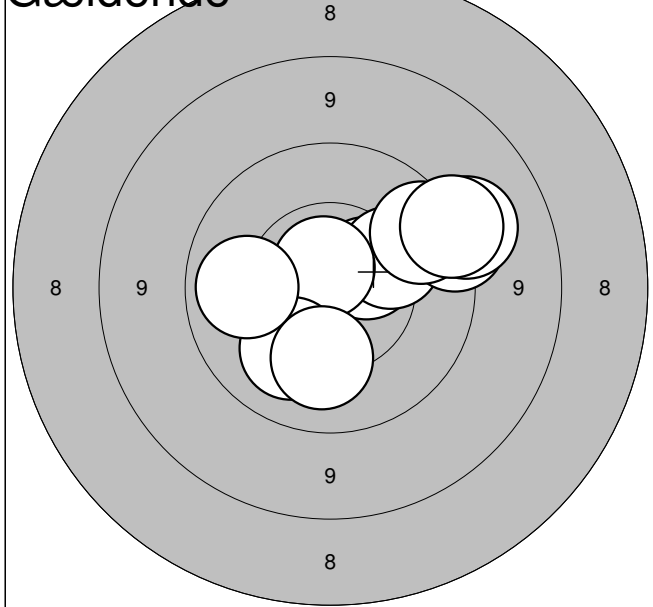
Serie: **96,0**Sum: **96,0****Gældende**

11:	10,5	↗
12:	10,2	↗
13:	10,7*	↖
14:	9,5	→
15:	10,2	↘
16:	10,2	↘
17:	9,3	↗
18:	9,8	↗
19:	10,1	←
20:	9,5	↗

Serie: **96,0**Sum: **192,0**

Jyllandsstævne 2011

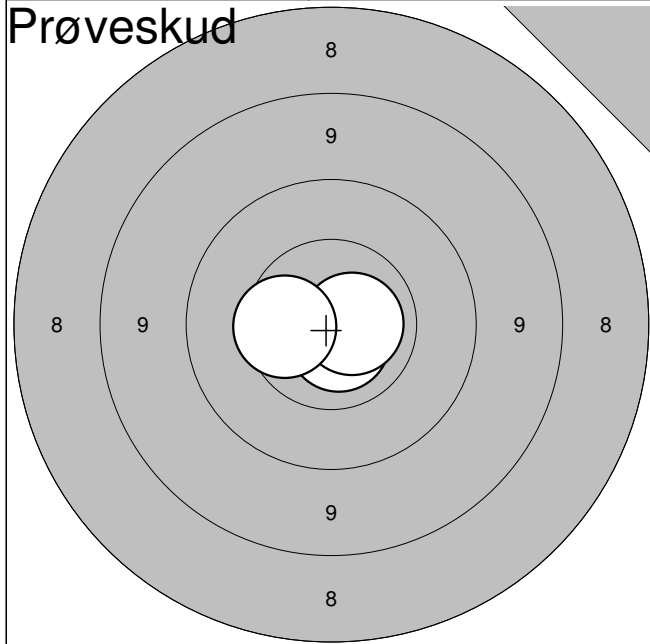

1:	10,8*	↓
2:	10,7*	→
3:	10,5	←

<b>Serie:</b>	<b>30,0</b>
<b>Sum:</b>	<b>0,0</b>

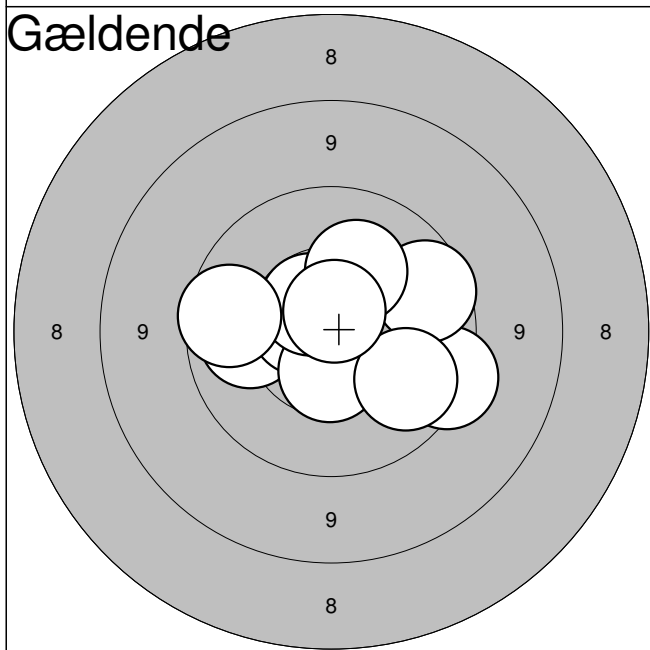

1:	10,1	←
2:	10,6*	←
3:	9,6	→
4:	10,5	↓
5:	10,6*	↗
6:	9,9	→
7:	10,3	↗
8:	10,0	↘
9:	10,7*	↑
10:	9,9	←

<b>Serie:</b>	<b>97,0</b>
<b>Sum:</b>	<b>97,0</b>

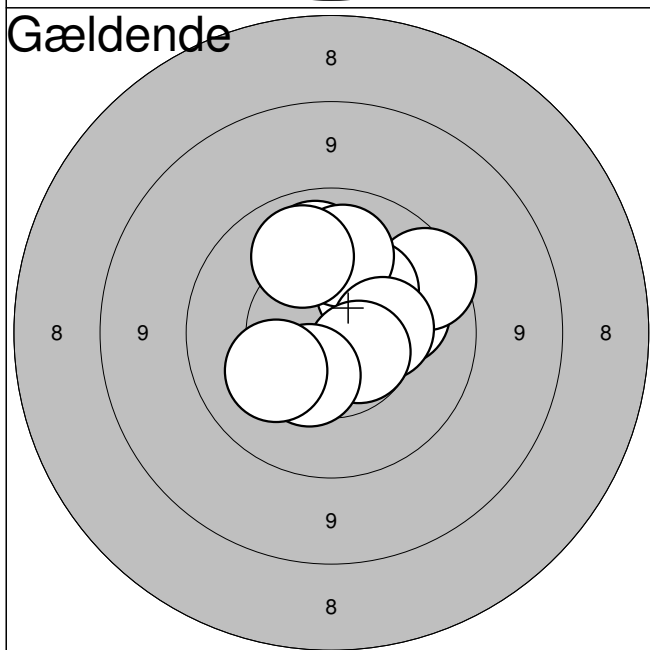

11:	10,2	→
12:	9,8	↗
13:	10,1	↑
14:	10,4	↗
15:	10,1	↑
16:	10,1	↑
17:	10,4	→
18:	10,6*	↘
19:	10,4	↓
20:	10,2	↙

<b>Serie:</b>	<b>99,0</b>
<b>Sum:</b>	<b>196,0</b>

Hold

49

Bane

5

Thomas Martinsen

Midtdjurs Skytteforening

ÅK2

Jyllandsstævne 2011 - riffel

Aalborg Skyttekreds

Prøveskud

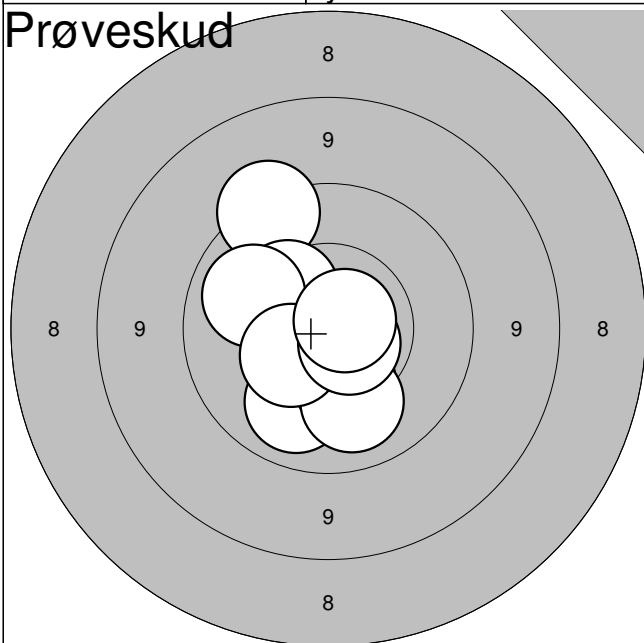

1:	10,1	↘
2:	10,3	↘
3:	10,1	↘
4:	9,5	↗
5:	10,4	↗
6:	10,1	↗
7:	10,5	↖
8:	10,7*	↘
9:	10,7*	↗

Serie: 89,0

Sum: 0,0

Gældende

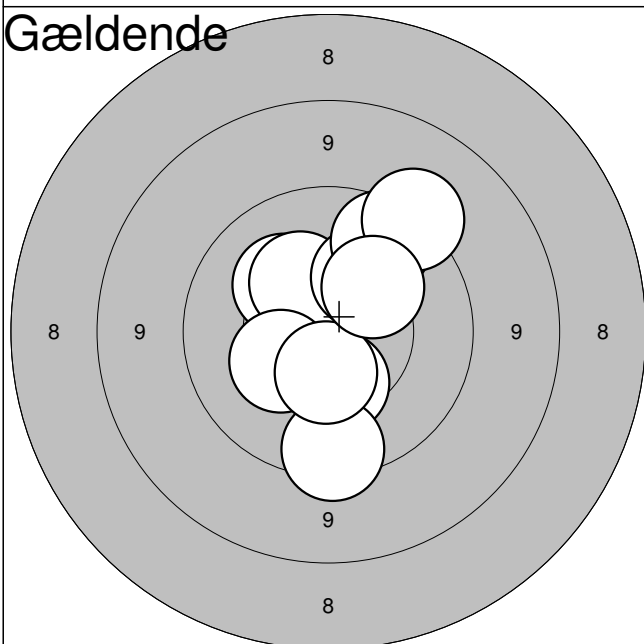

1:	10,4	↘
2:	9,7	↘
3:	10,3	↗
4:	10,4	↗
5:	10,4	↖
6:	10,3	↗
7:	10,5	↘
8:	9,8	↗
9:	9,4	↗
10:	10,3	↗

Serie: 97,0

Sum: 97,0

Gældende

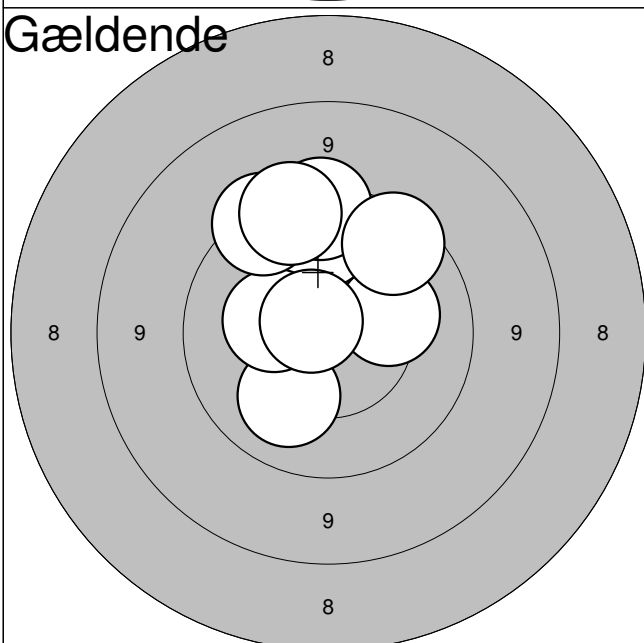

11:	10,2	↘
12:	10,3	→
13:	9,9	↑
14:	9,9	↑
15:	10,4	↖
16:	10,7*	↗
17:	9,6	↗
18:	9,6	↑
19:	9,8	↗
20:	9,6	↑

Serie: 94,0

Sum: 191,0

Jyllandsstævne 2011

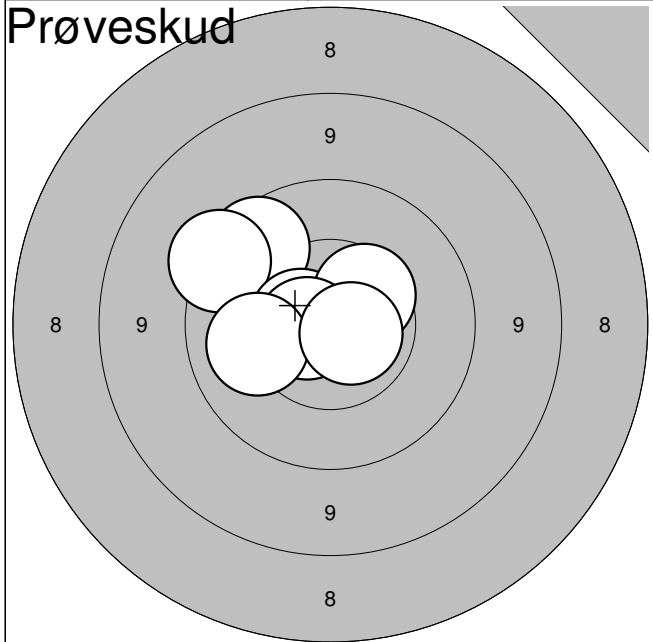

1:	9,8	↗
2:	9,6	↗
3:	10,6*	↖
4:	10,5	↗
5:	10,7*	↖
6:	10,2	↖
7:	10,7*	↘

<b>Serie:</b>	<b>68,0</b>
<b>Sum:</b>	<b>0,0</b>

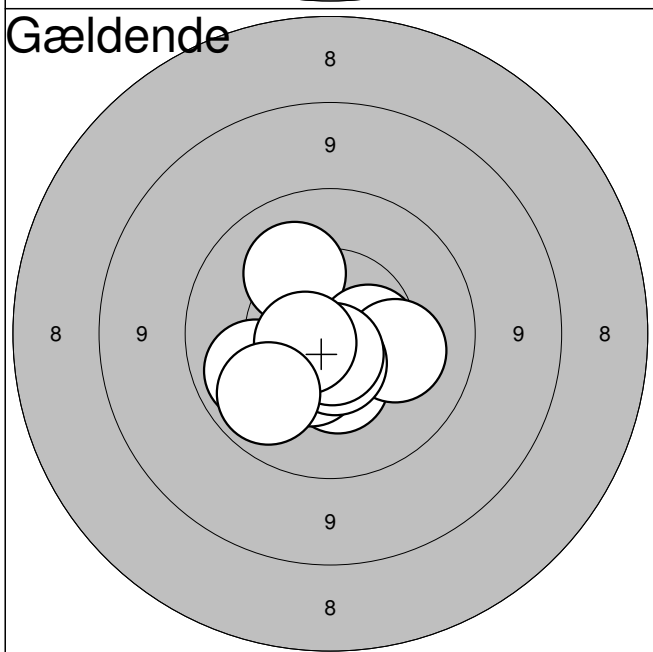

1:	10,2	↗
2:	10,5	→
3:	10,4	↓
4:	10,2	→
5:	10,5	↓
6:	10,1	↖
7:	10,6*	↓
8:	10,7*	↓
9:	10,7*	↖
10:	10,0	↘

<b>Serie:</b>	<b>100,0</b>
<b>Sum:</b>	<b>100,0</b>

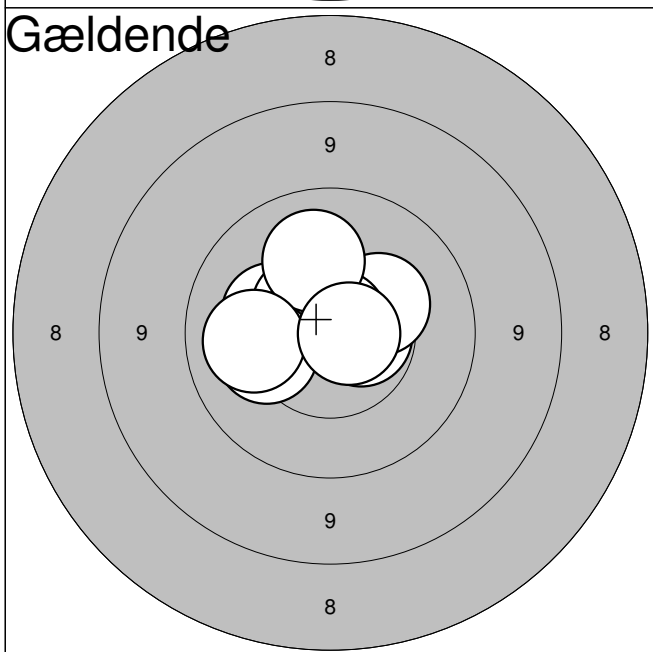

11:	10,6*	→
12:	10,4	↗
13:	10,3	↖
14:	10,6	↗
15:	10,7*	↗
16:	10,8*	↗
17:	10,3	↖
18:	10,2	↑
19:	10,1	↖
20:	10,7*	→

<b>Serie:</b>	<b>100,0</b>
<b>Sum:</b>	<b>200,0</b>



Hold  
**49**Bane  
**7****Philip Kristensen**

Midtdjurs Skytteforening

BK1

Jyllandsstævne 2011 - riffel

Aalborg Skyttekreds

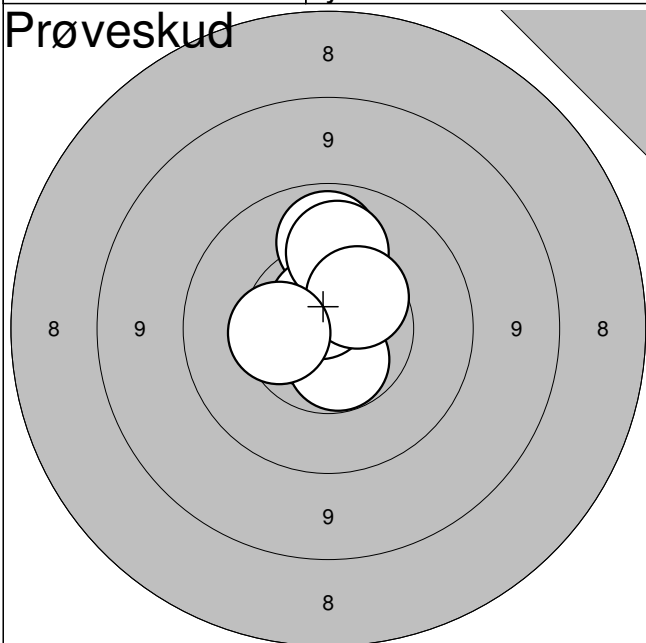
**Prøveskud**

1:	10,6	↑
2:	10,7*	←
3:	10,7*	←
4:	10,6*	↓
5:	10,0	↑
6:	10,7*	↑
7:	10,1	↑
8:	10,5	↗
9:	10,4	←

Serie: 90,0

Sum: 0,0

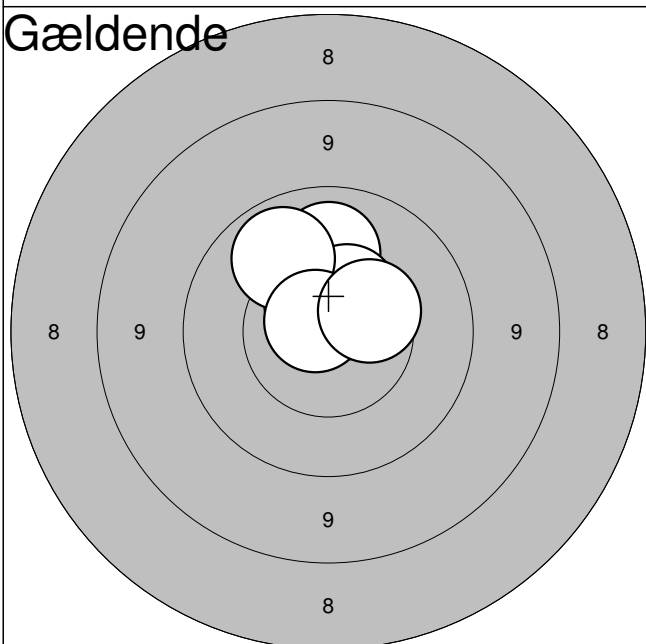
**Gældende**

1:	10,1	↑
2:	10,6*	↑
3:	10,6*	↑
4:	10,6*	↑
5:	10,7*	↗
6:	10,6*	↑
7:	10,5	↗
8:	10,0	↗
9:	10,8*	↗
10:	10,5	↗

Serie: 100,0

Sum: 100,0

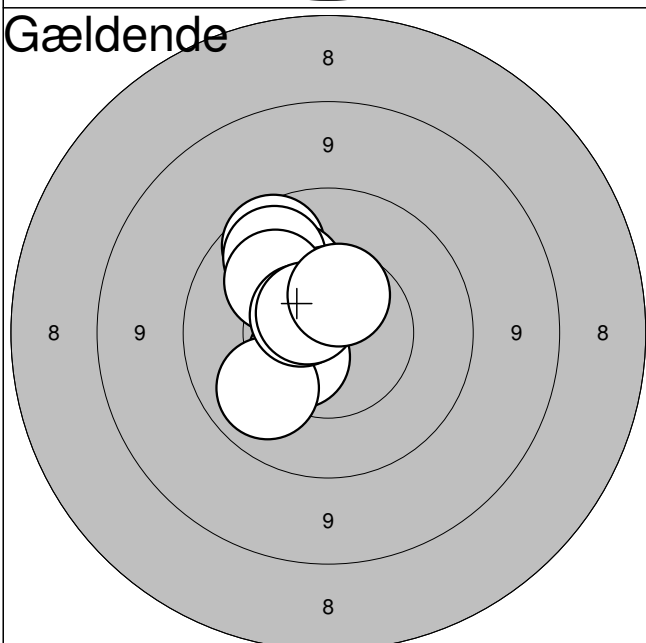
**Gældende**

11:	9,9	↗
12:	10,2	↗
13:	10,0	↗
14:	10,6	↑
15:	10,2	↗
16:	10,5	↖
17:	10,1	↖
18:	10,6*	↗
19:	10,6*	↗
20:	10,5	↑

Serie: 99,0

Sum: 199,0

Jyllandsstævne 2011

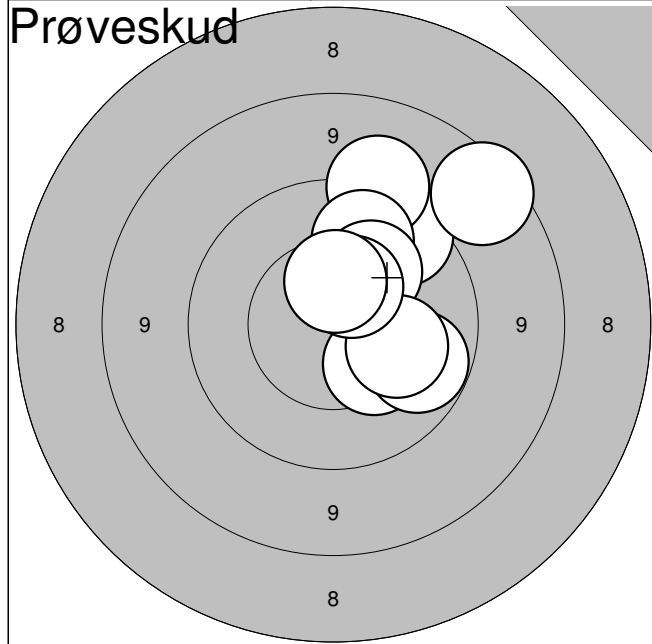

1:	9,7	↗
2:	8,7	↗
3:	9,4	↑
4:	10,0	↑
5:	10,3	↘
6:	10,0	→
7:	10,3	↗
8:	10,2	→
9:	10,5	↗
10:	10,5	↑

**Serie: 96,0**

**Sum: 0,0**

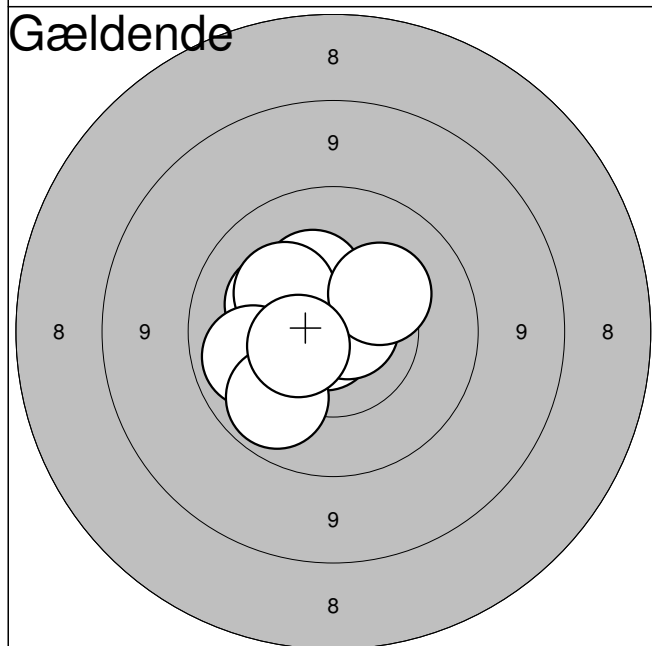

1:	10,4	↑
2:	10,3	↖
3:	10,8*	↘
4:	10,8*	→
5:	10,5	↖
6:	10,3	↗
7:	10,1	↖
8:	10,0	↘
9:	10,3	↗
10:	10,6	↖

**Serie: 100,0**

**Sum: 100,0**

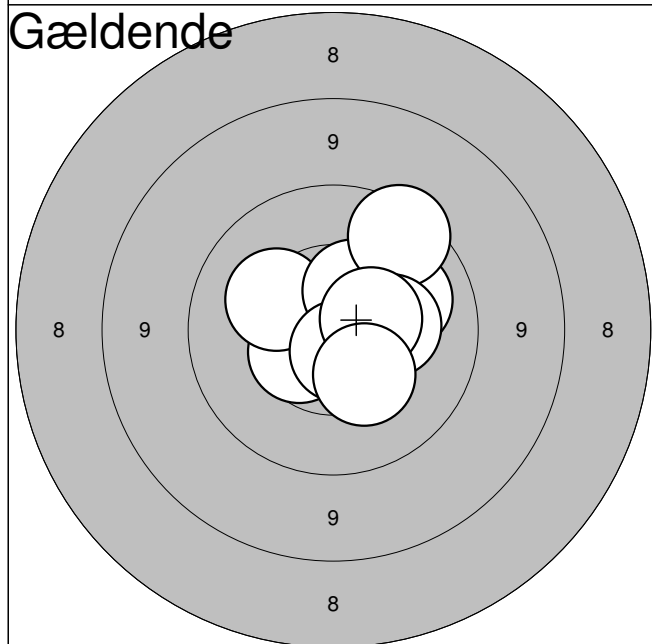

11:	10,5	↖
12:	10,3	↖
13:	10,2	→
14:	10,5	↑
15:	10,5	↘
16:	10,7*	↘
17:	9,7	↗
18:	10,3	→
19:	10,5	→
20:	10,4	↘

**Serie: 99,0**

**Sum: 199,0**

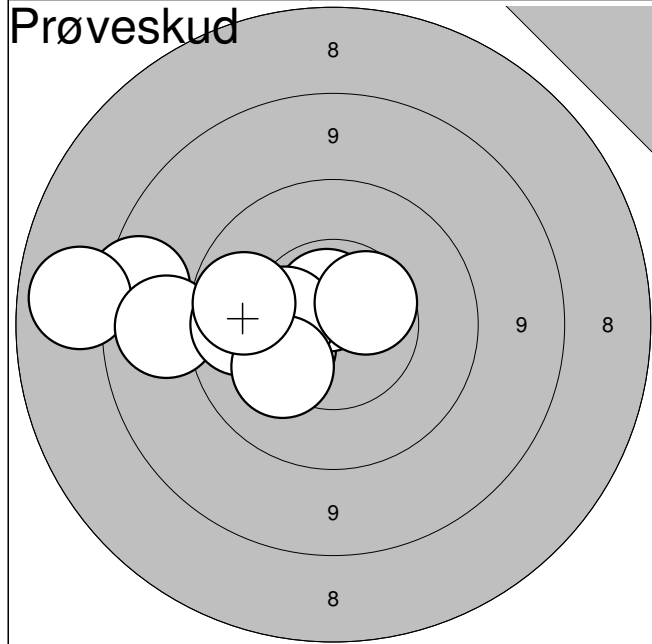

1:	8,7	←
2:	8,1	←
3:	9,1	←
4:	10,4	←
5:	10,0	←
6:	10,7*	↑
7:	10,4	←
8:	10,3	↙
9:	10,0	←
10:	10,5	↗

**Serie: 95,0**

**Sum: 0,0**

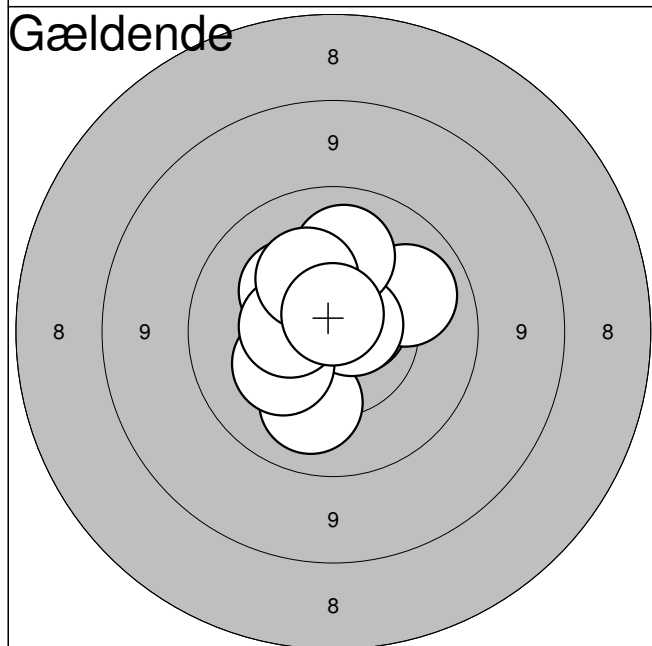

1:	10,2	↓
2:	10,3	↖
3:	10,7*	→
4:	10,1	→
5:	10,7*	→
6:	10,3	←
7:	10,1	↑
8:	10,5	←
9:	10,3	↖
10:	10,8*	↑

**Serie: 100,0**

**Sum: 100,0**

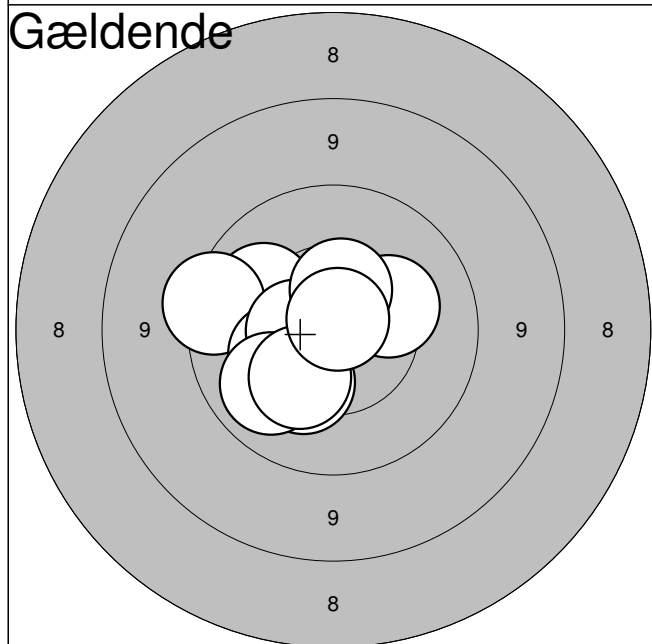

11:	10,1	←
12:	9,6	←
13:	10,3	←
14:	10,3	→
15:	10,3	↙
16:	10,6	←
17:	10,1	↙
18:	10,5	↑
19:	10,3	↙
20:	10,8*	↗

**Serie: 99,0**

**Sum: 199,0**

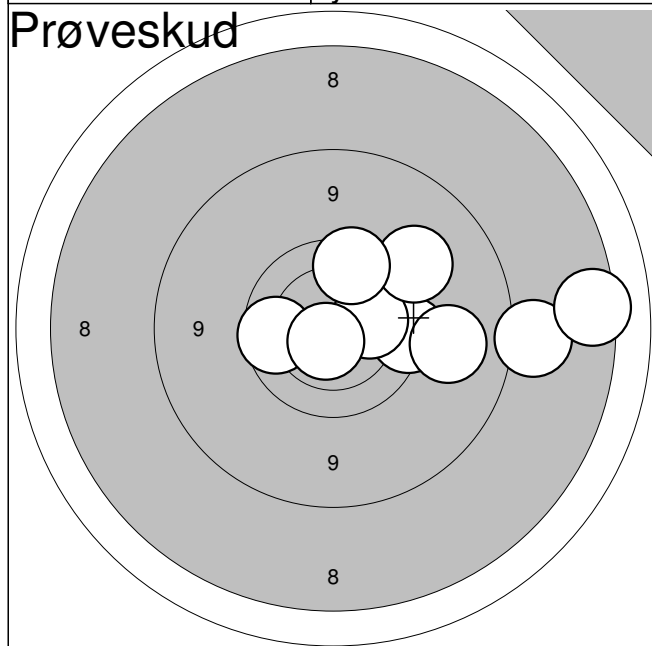

1:	9,7	→
2:	8,5	→
3:	10,2	→
4:	9,2	→
5:	8,1	→
6:	9,9	←
7:	9,4	↗
8:	9,8	↑
9:	10,7*	↓

<b>Serie:</b>	<b>81,0</b>
<b>Sum:</b>	<b>0,0</b>

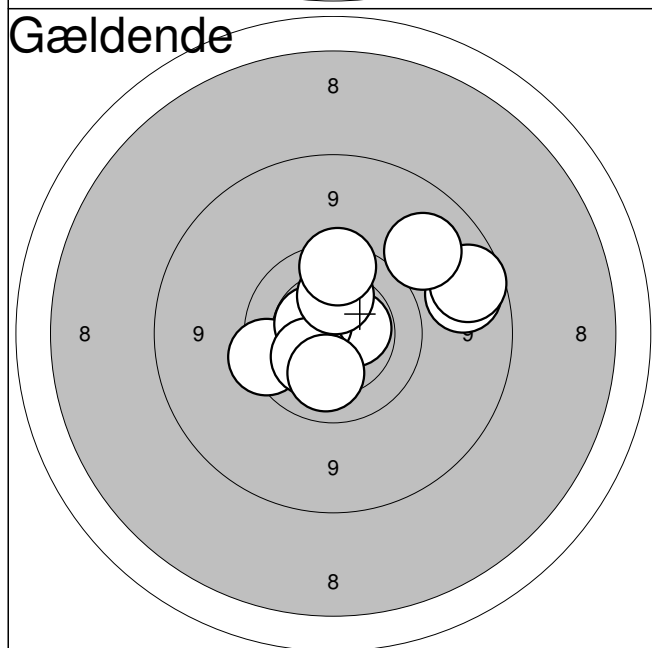

1:	10,6*	→
2:	9,0	→
3:	9,7	←
4:	10,5*	↖
5:	8,9	→
6:	10,3	↙
7:	10,2	↓
8:	10,2	↑
9:	9,8	↑
10:	9,2	↗

<b>Serie:</b>	<b>94,0</b>
<b>Sum:</b>	<b>94,0</b>

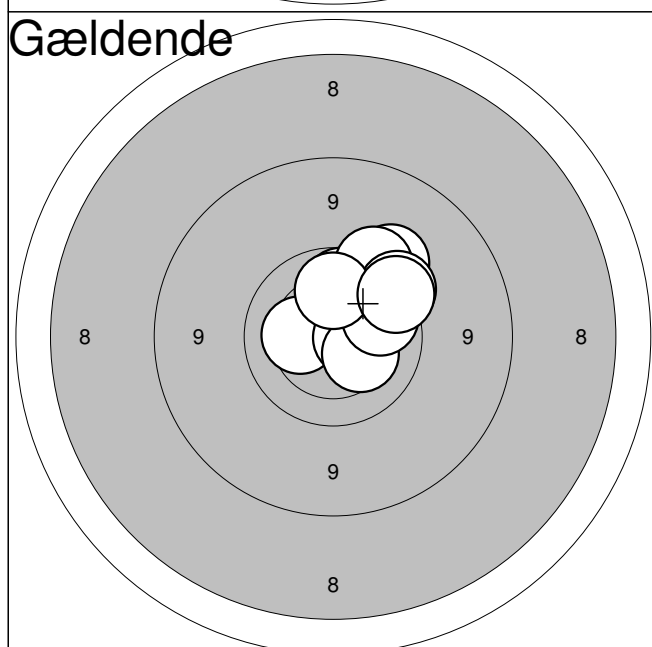

11:	10,0	↑
12:	10,3	←
13:	10,6*	→
14:	9,5	↗
15:	10,3	↘
16:	9,6	↗
17:	9,6	↗
18:	10,0	→
19:	10,1	↑
20:	9,7	↗

<b>Serie:</b>	<b>96,0</b>
<b>Sum:</b>	<b>190,0</b>

Hold  
**49**

Bane  
**11**

# Tobias Engberg Hansen

Vilsted Skf.

BK2

Jyllandsstævne 2011 - riffel

Aalborg Skyttekreds

## Prøveskud

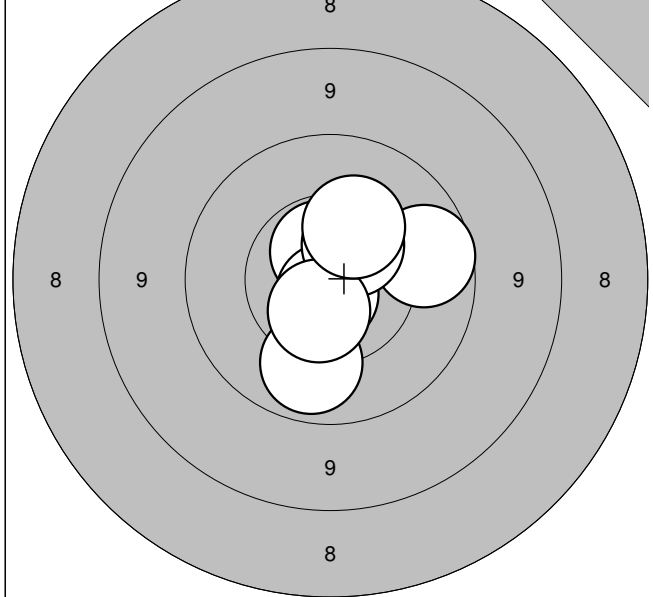

1:	9,9	→
2:	10,6*	↑
3:	10,0	↓
4:	10,8*	↓
5:	10,5	↗
6:	10,6*	↓
7:	10,3	↗

Serie: 69,0

Sum: 0,0

## Gældende

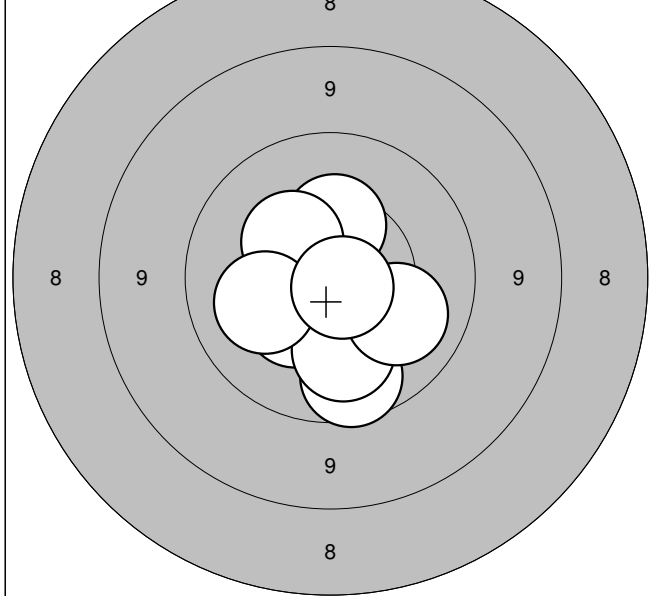

1:	10,5	↓
2:	10,7*	←
3:	9,9	↓
4:	10,4	↙
5:	10,4	↑
6:	10,4	↗
7:	10,2	↓
8:	10,2	←
9:	10,1	↘
10:	10,8*	↘

Serie: 99,0

Sum: 99,0

## Gældende

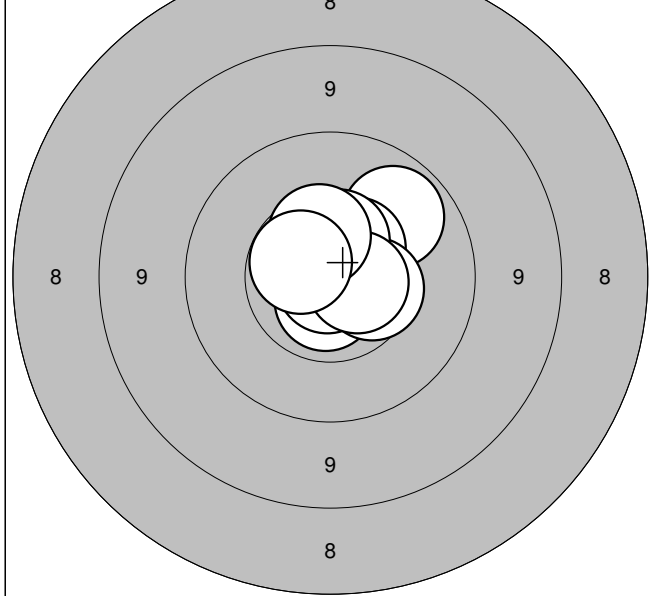

11:	10,0	↗
12:	10,6	↗
13:	10,7*	↓
14:	10,9*	↓
15:	10,7*	↗
16:	10,5	→
17:	10,6	↑
18:	10,7*	→
19:	10,5	↑
20:	10,6*	←

Serie: 100,0

Sum: 199,0

Jyllandsstævne 2011

Hold  
**49**Bane  
**12****Mathias Christensen**

Vilsted Skf.

BK2

Jyllandsstævne 2011 - riffel

Aalborg Skyttekreds

Prøveskud

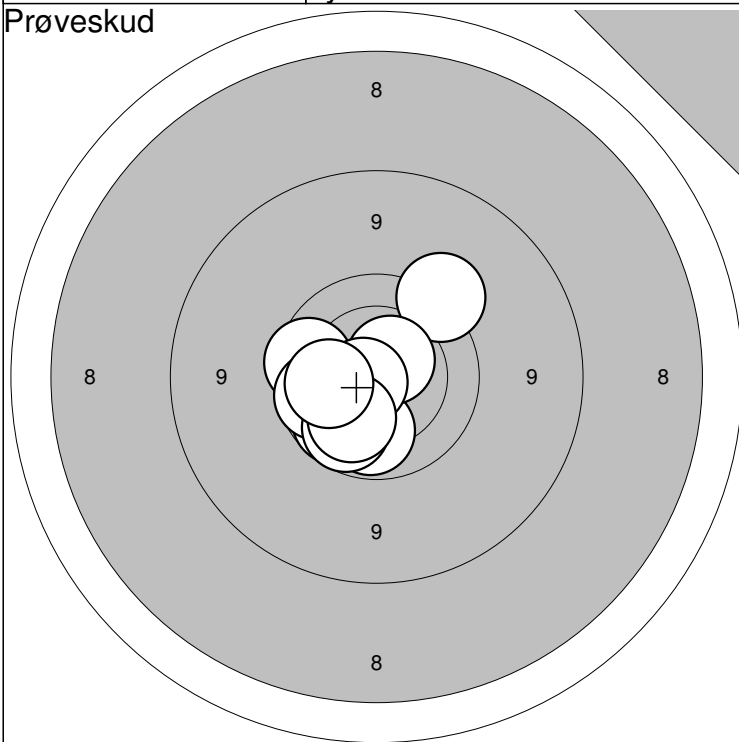

Prøveskud

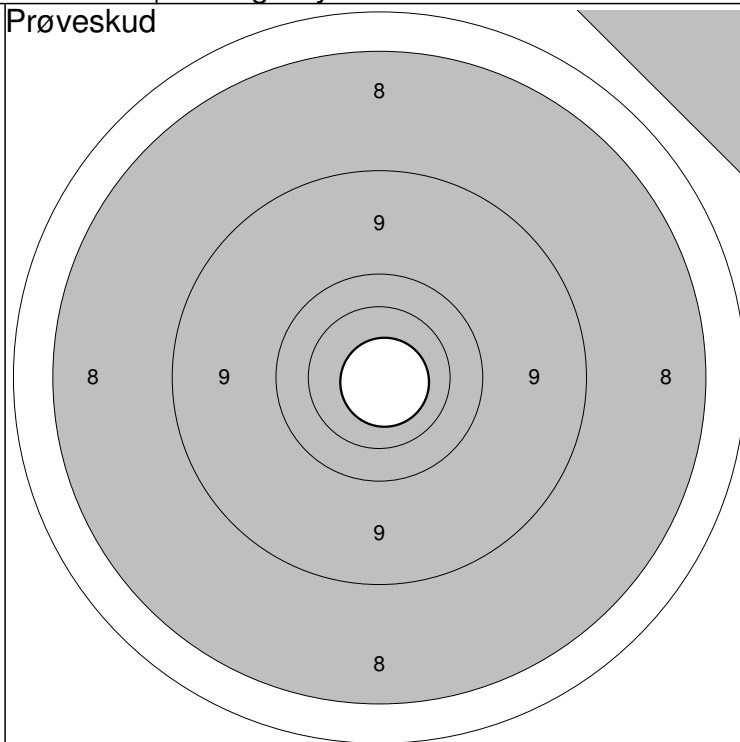

1: 9,5 ↗

2: 9,9 ←

3: 9,9 ↘

4: 9,9 ←

5:10,0 ↓

6: 9,9 ↘

7:10,6\* ↗

8:10,7\* ←

9:10,1 ↘

10:10,1 ←

Serie:

95,0

Sum:

0,0

11:10,8\* ↘

Serie:

10,0

Sum:

0,0

Gældende

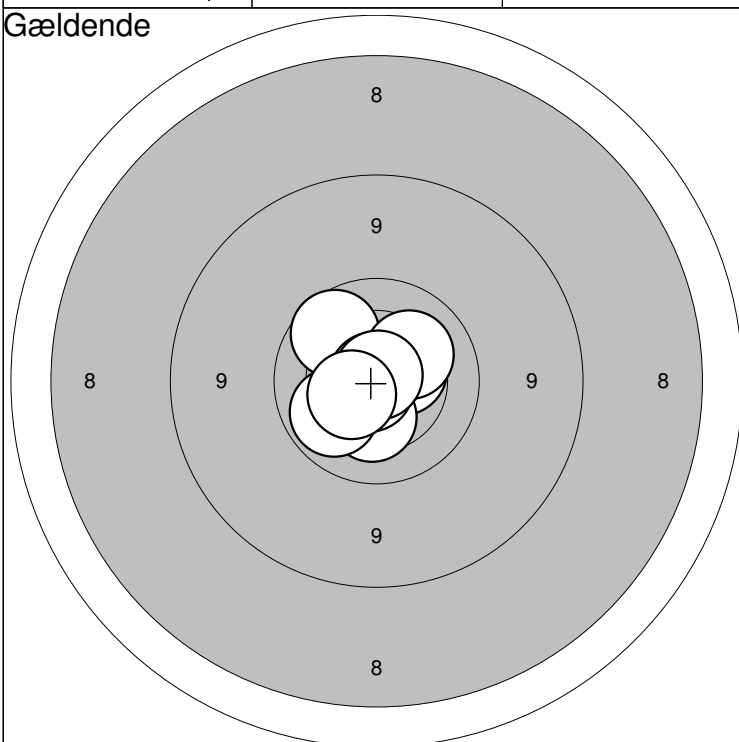

Gældende

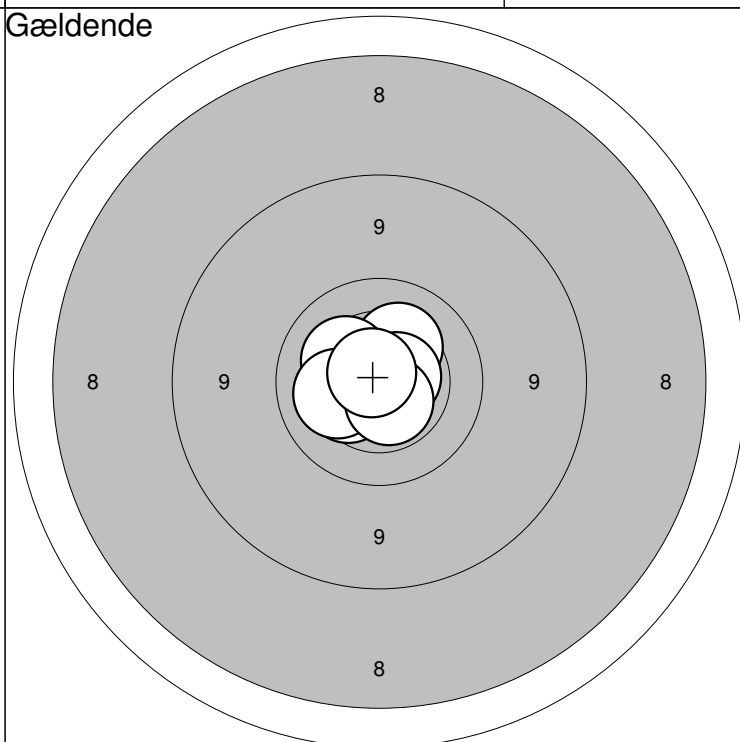

1: 9,9 ↖

2:10,5 →

3:10,4 ↓

4:10,3 ↓

5:10,8\* ↙

6:10,9\* ↖

7:10,2 ↗

8:10,9\* ↑

9:10,1 ←

10:10,5 ←

Serie:

99,0

Sum:

99,0

11:10,8\* ←

12:10,5\* ↗

13:10,3 ↗

14:10,6\* →

15:10,3 ↗

16:10,4 ←

17:10,8\* ←

18:10,2 ←

19:10,6\* ↘

20:10,8\* ↗

Serie:

100,0

Sum:

199,0

Jyllandsstævne 2011

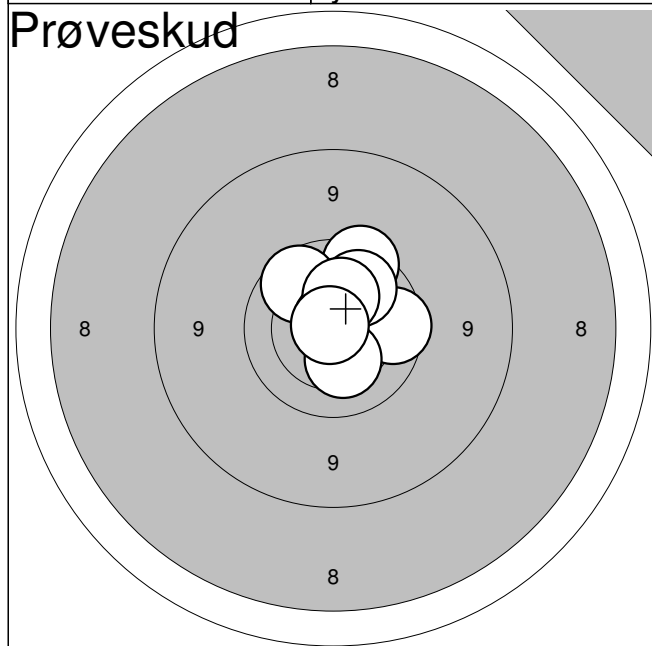

1:	9,7	↗
2:	10,4	↗
3:	9,9	↗
4:	10,8*	↑
5:	9,9	→
6:	10,0	↗
7:	10,3	↑
8:	10,3	↘
9:	10,9*	↗

**Serie: 87,0**

**Sum: 0,0**

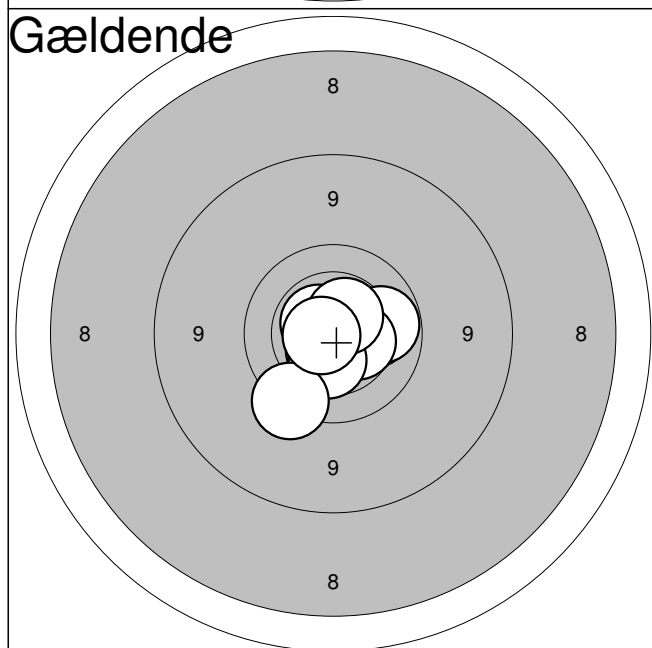

1:	10,2	→
2:	10,0	→
3:	10,6*	↗
4:	10,6*	↘
5:	10,5	→
6:	10,6*	↘
7:	10,4	↘
8:	10,5*	↗
9:	9,6	↘
10:	10,7*	←

**Serie: 99,0**

**Sum: 99,0**

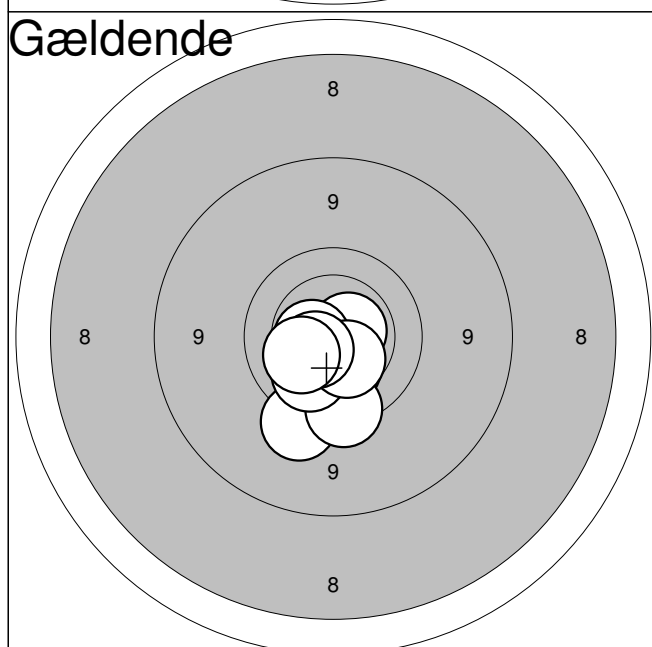

11:	9,5	↘
12:	10,6*	→
13:	10,3	↘
14:	10,3	↘
15:	9,7	↘
16:	10,1	↘
17:	10,5*	←
18:	10,4	↘
19:	10,5*	↘
20:	10,2	↘

**Serie: 98,0**

**Sum: 197,0**

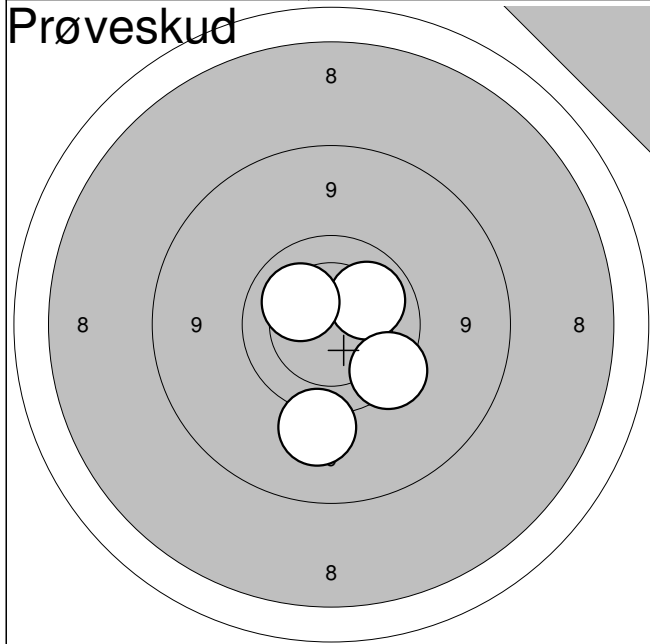

1:	10,1	↗
2:	9,4	↓
3:	10,2	↗
4:	9,7	↓

**Serie: 38,0**

**Sum: 0,0**

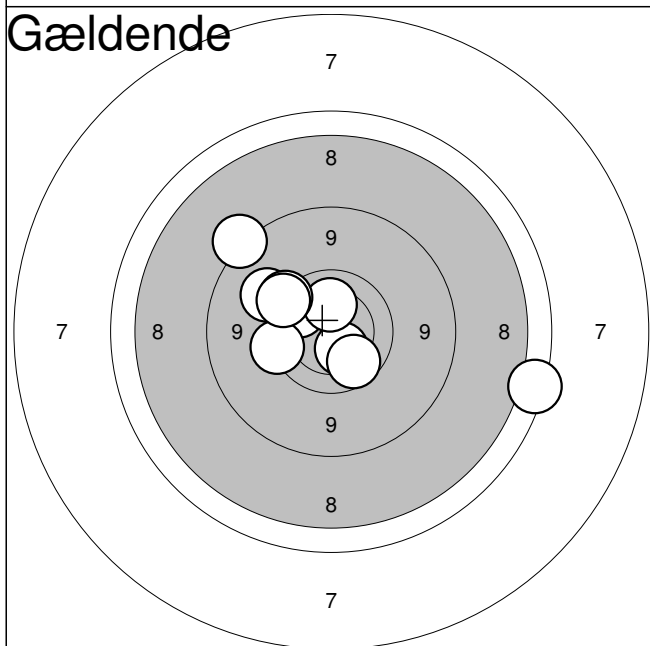

1:	8,6	↗
2:	7,8	→
3:	9,9	↗
4:	9,3	↗
5:	10,4	↓
6:	9,6	←
7:	10,2	↑
8:	9,6	↗
9:	9,6	↗
10:	9,9	↓

**Serie: 89,0**

**Sum: 89,0**

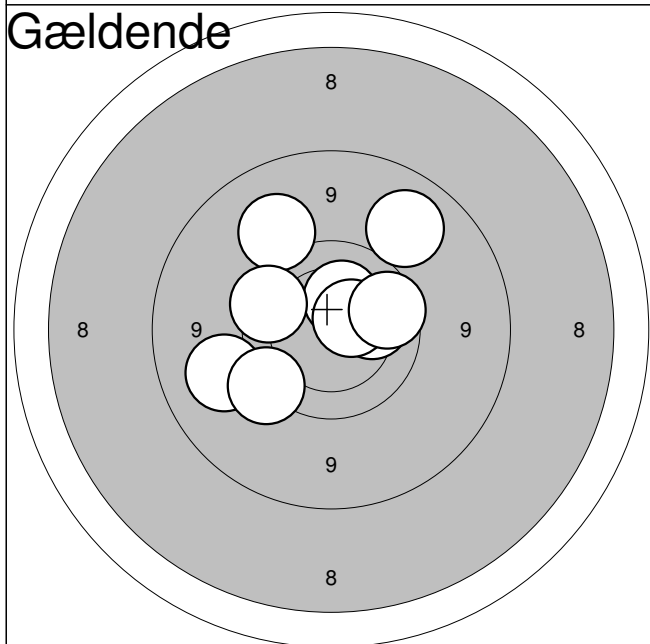

11:	9,1	↗
12:	10,2	→
13:	10,1	→
14:	10,3	↑
15:	10,5*	↗
16:	9,2	←
17:	9,3	↗
18:	9,6	↙
19:	9,8	←
20:	9,9	→

**Serie: 94,0**

**Sum: 183,0**



Hold  
**50**

Bane  
**3**

# Kasper Nørgaard Hansen

Aalborg Skyttekreds

UNG

Jyllandsstævne 2011 - riffel

Aalborg Skyttekreds

Prøveskud

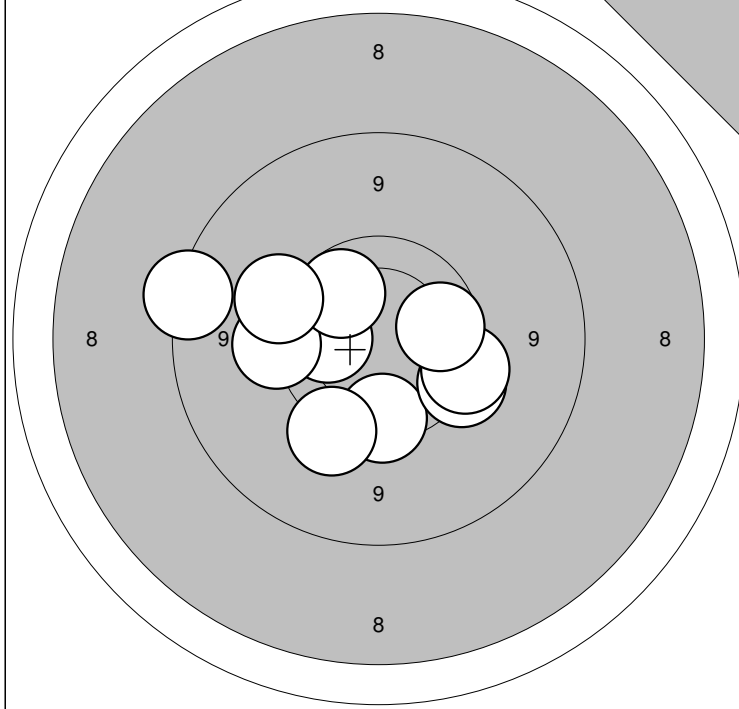

Prøveskud

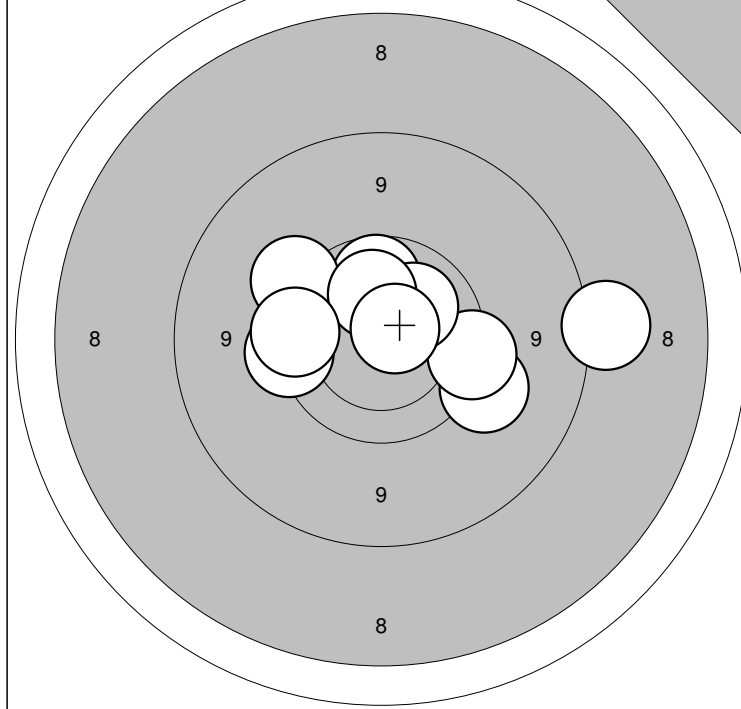

1:10,1	←	6: 9,5	←	Serie: 91,0
2: 9,7	↓	7:10,0	↗	
3: 8,7	←	8: 9,5	←	Sum: 0,0
4: 9,6	↘	9: 9,6	↘	
5: 9,5	↙	10: 9,9	→	

11: 9,9	↑	16:10,2	↗	Serie: 92,0
12: 9,4	↘	17:10,2	↑	
13: 9,6	←	18: 8,6	→	Sum: 0,0
14: 9,5	↖	19:10,7*	↗	
15: 9,6	→	20: 9,7	←	

Gældende

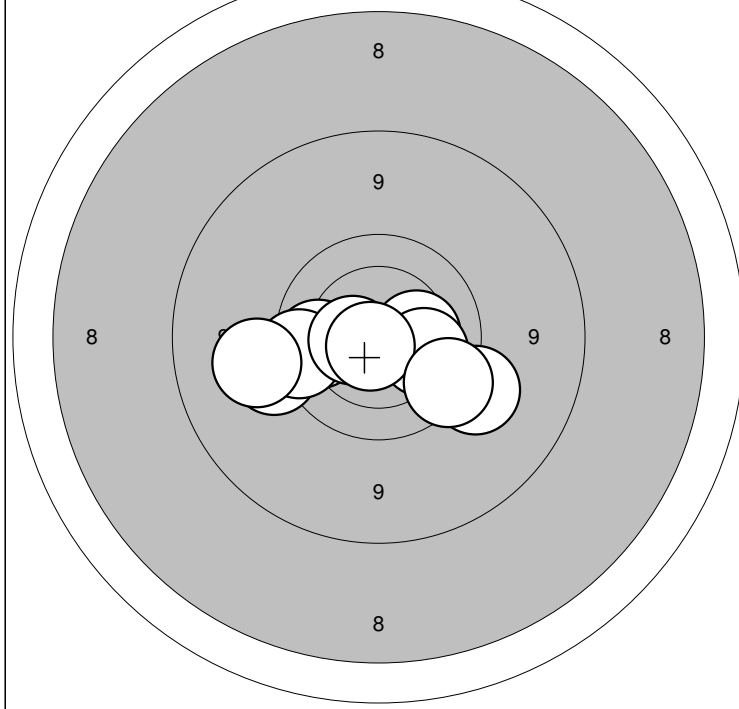

Gældende

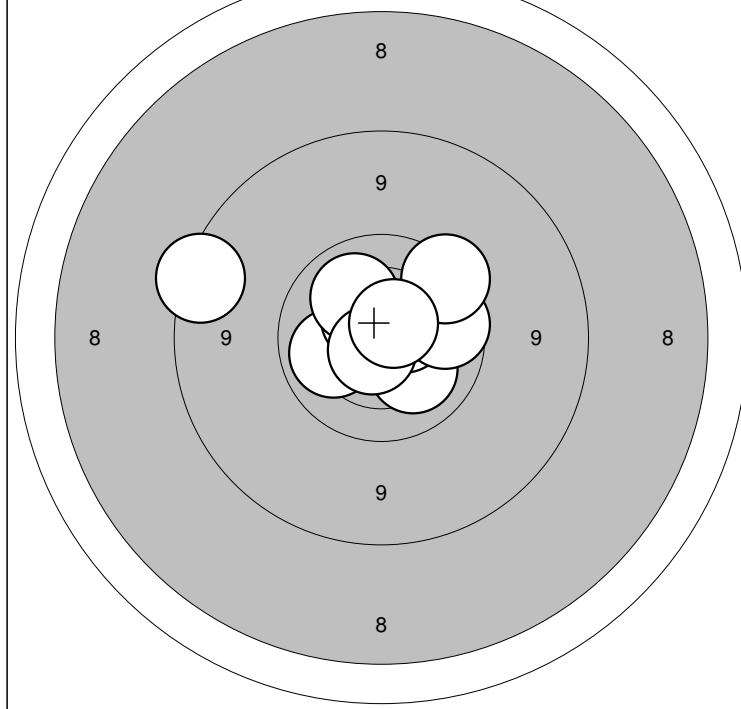

1:10,3	→	6: 9,3	←	Serie: 94,0
2:10,1	↘	7:10,5*	←	
3: 9,9	←	8:10,7*	↙	Sum: 94,0
4: 9,5	←	9: 9,4	↘	
5: 9,7	←	10: 9,7	↘	

11: 8,8	←	16:10,5*	→	Serie: 96,0
12:10,1	←	17: 9,9	→	
13:10,5*	↗	18:10,7*	↙	Sum: 190,0
14:10,1	↗	19: 9,7	↗	
15:10,2	↙	20:10,6*	↗	

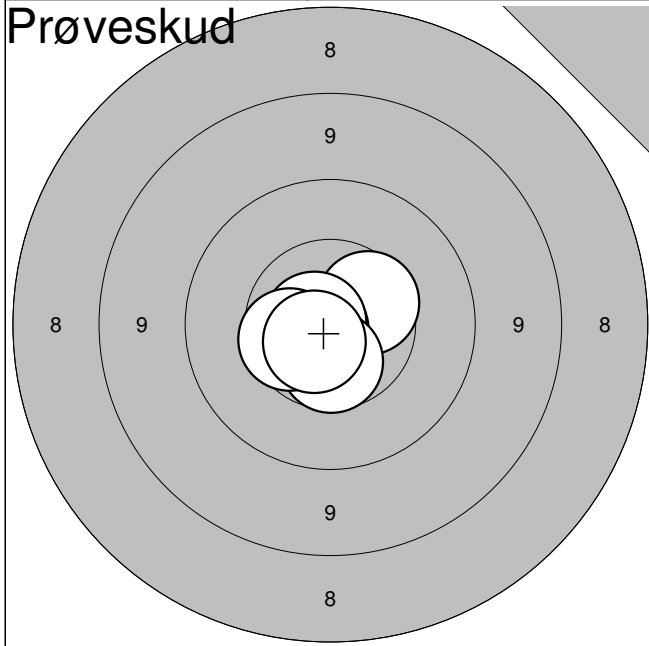

1:	10,5	↗
2:	10,8*	↖
3:	10,8*	↖
4:	10,6	↓
5:	10,5	↖
6:	10,7*	↘

<b>Serie:</b>	<b>60,0</b>
<b>Sum:</b>	<b>0,0</b>

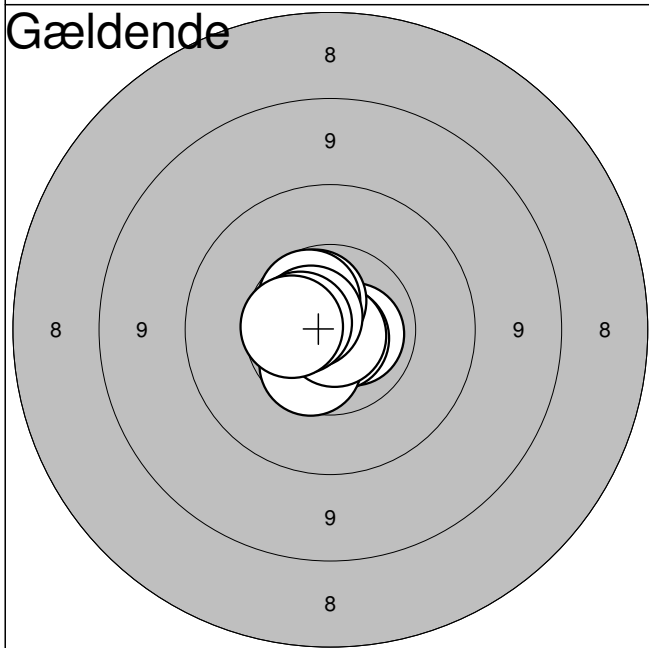

1:	10,7*	↖
2:	10,7*	→
3:	10,8*	↘
4:	10,5	↘
5:	10,9*	↘
6:	10,6*	↗
7:	10,6	↗
8:	10,7*	↗
9:	10,6*	↖
10:	10,5	←

<b>Serie:</b>	<b>100,0</b>
<b>Sum:</b>	<b>100,0</b>

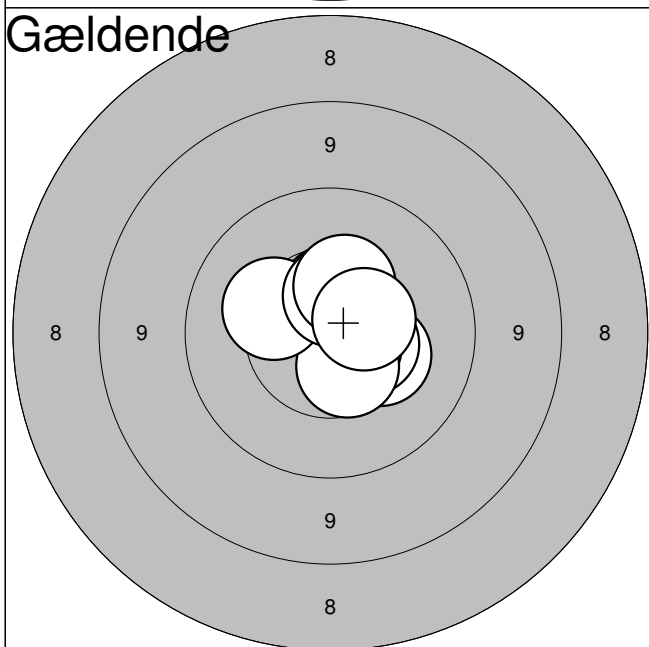

11:	10,4	↘
12:	10,6	↑
13:	10,7*	↗
14:	10,5	→
15:	10,7*	↘
16:	10,5	↘
17:	10,3	↖
18:	10,6	↑
19:	10,4	↑
20:	10,6	→

<b>Serie:</b>	<b>100,0</b>
<b>Sum:</b>	<b>200,0</b>

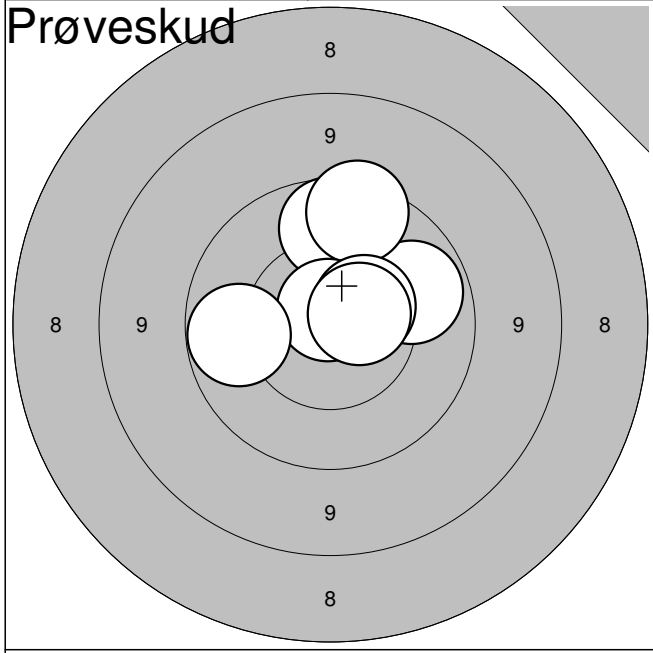

1:	10,0	→
2:	9,9	↑
3:	9,7	↑
4:	10,8*	↑
5:	10,5	→
6:	10,0	←
7:	10,6*	→

**Serie: 68,0**

**Sum: 0,0**

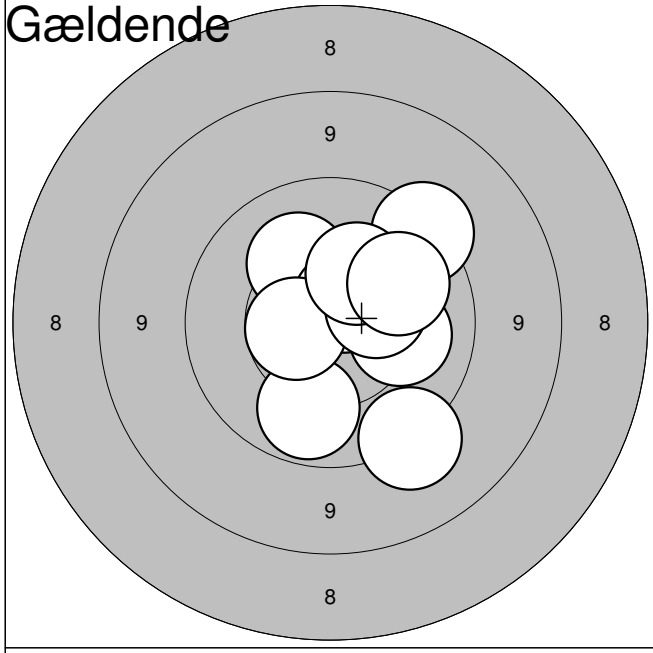

1:	9,4	↓
2:	10,2	→
3:	10,0	↓
4:	10,2	↑
5:	9,6	↗
6:	10,7*	↗
7:	10,6	←
8:	10,4	→
9:	10,4	↗
10:	10,1	↗

**Serie: 98,0**

**Sum: 98,0**

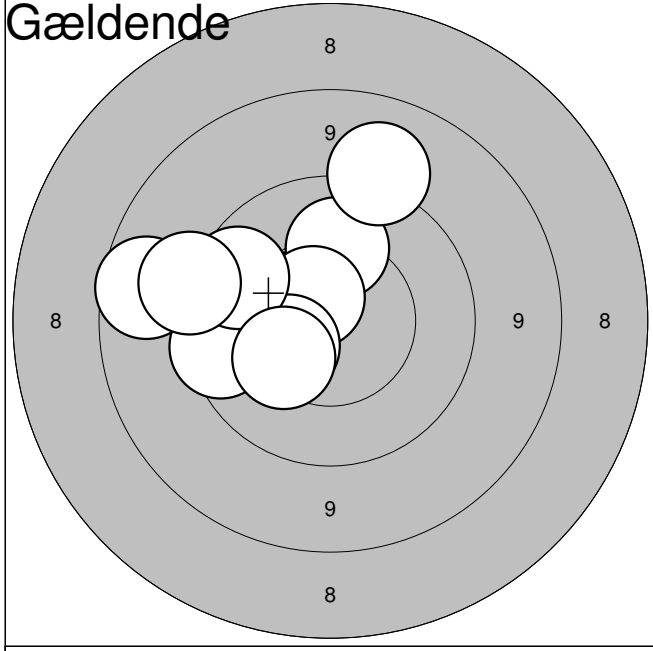

11:	10,2	↑
12:	10,4	←
13:	9,7	←
14:	10,7*	↗
15:	10,4	↙
16:	9,9	↙
17:	10,3	↙
18:	8,9	←
19:	9,4	←
20:	9,2	↑

**Serie: 94,0**

**Sum: 192,0**

Hold

50

Bane

7

## Asbjørn Risgård Nielsen

Vilsted Skf.

BK1

Jyllandsstævne 2011 - riffel

Aalborg Skyttekreds

## Prøveskud

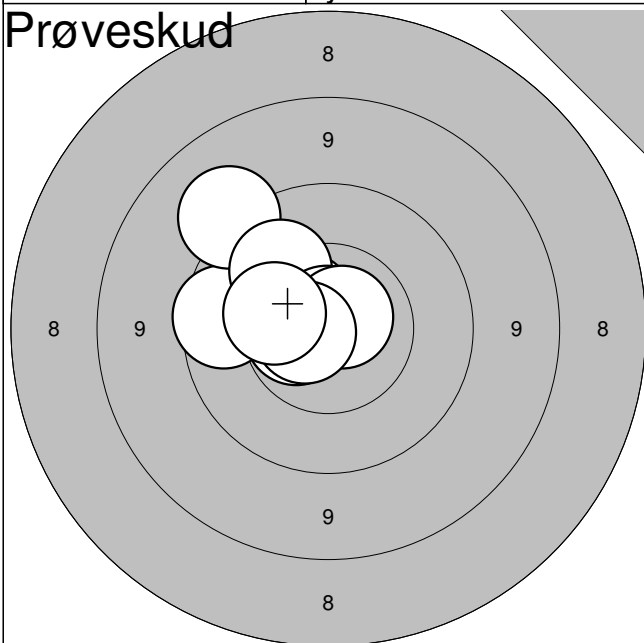

1: 10,6\* ←  
 2: 9,8 ←  
 3: 10,6 ↗  
 4: 9,3 ↗  
 5: 10,2 ↗  
 6: 10,8\* ↑  
 7: 10,8\* ↗  
 8: 10,7\* ←  
 9: 10,4 ←

Serie: 88,0

Sum: 0,0

## Gældende

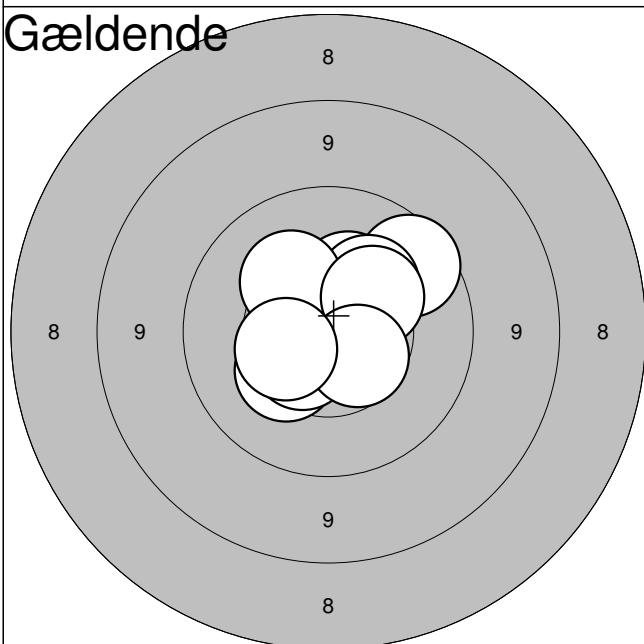

1: 10,3 ↙  
 2: 10,6 ↙  
 3: 10,6 ↗  
 4: 9,8 ↗  
 5: 10,4 ↑  
 6: 10,3 ↗  
 7: 10,3 ↗  
 8: 10,4 ↗  
 9: 10,5 ↘  
 10: 10,5 ←

Serie: 99,0

Sum: 99,0

## Gældende

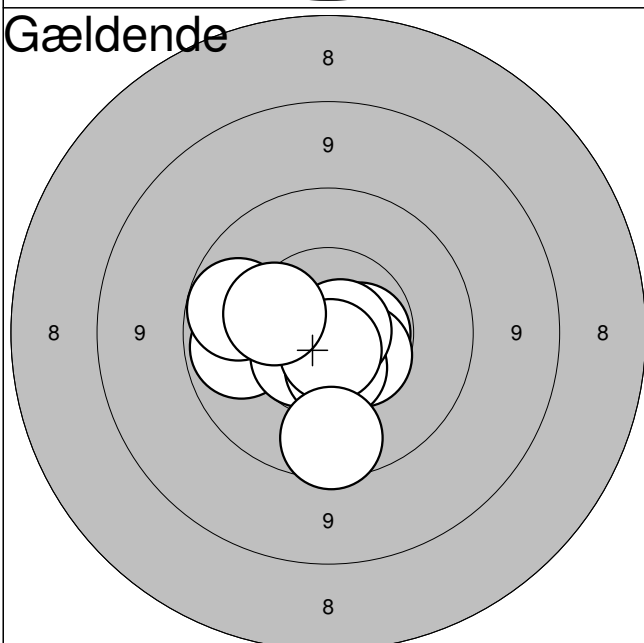

11: 10,0 ←  
 12: 10,6\* →  
 13: 10,5 ↘  
 14: 10,6 ↙  
 15: 10,6 ↘  
 16: 10,8\* →  
 17: 10,8\* ↘  
 18: 9,8 ↘  
 19: 10,0 ←  
 20: 10,4 ←

Serie: 99,0

Sum: 198,0

Jyllandsstævne 2011

Hold  
**50**

Bane  
**9**

# Morten Aagaard Christensen

Vilsted Skf.

ÅK2

Jyllandsstævne 2011 - riffel

Aalborg Skyttekreds

## Prøveskud

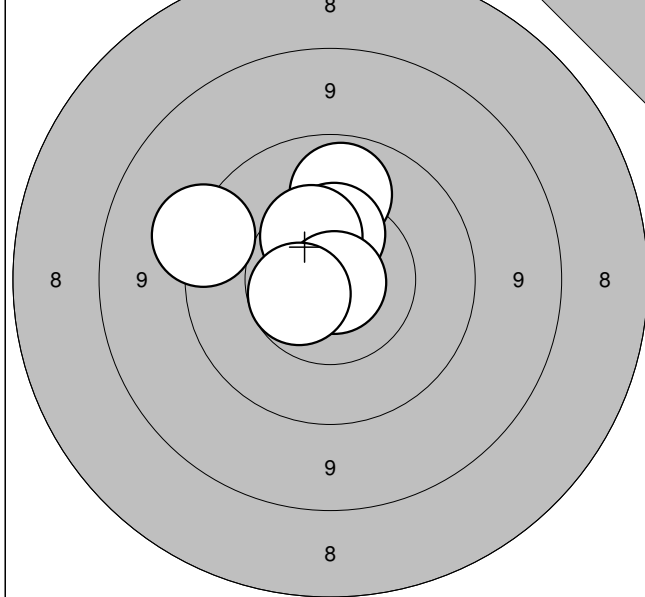

1:	10,0	↑
2:	10,5	↑
3:	10,5	↗
4:	9,5	↖
5:	10,9*	↘
6:	10,6*	↖

Serie: **59,0**

Sum: **0,0**

## Gældende

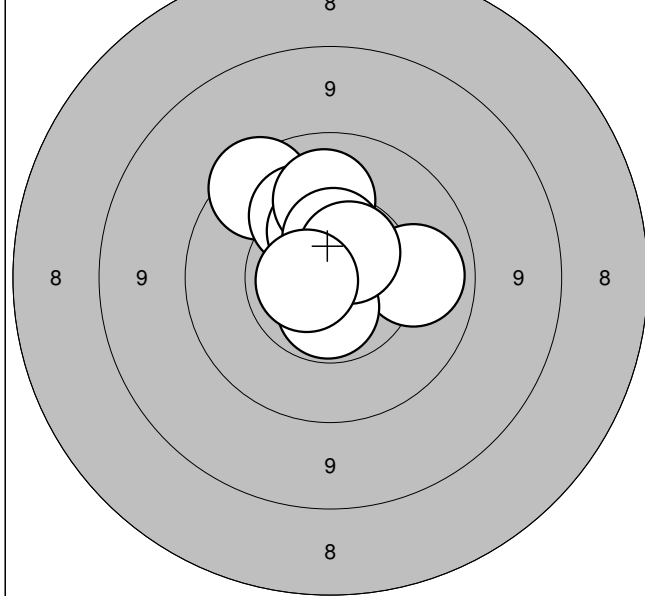

1:	9,7	↗
2:	10,2	↗
3:	10,4	↑
4:	10,1	↑
5:	10,1	→
6:	10,8*	↑
7:	10,6*	↓
8:	10,5	↑
9:	10,6*	↗
10:	10,7*	↖

Serie: **99,0**

Sum: **99,0**

## Gældende

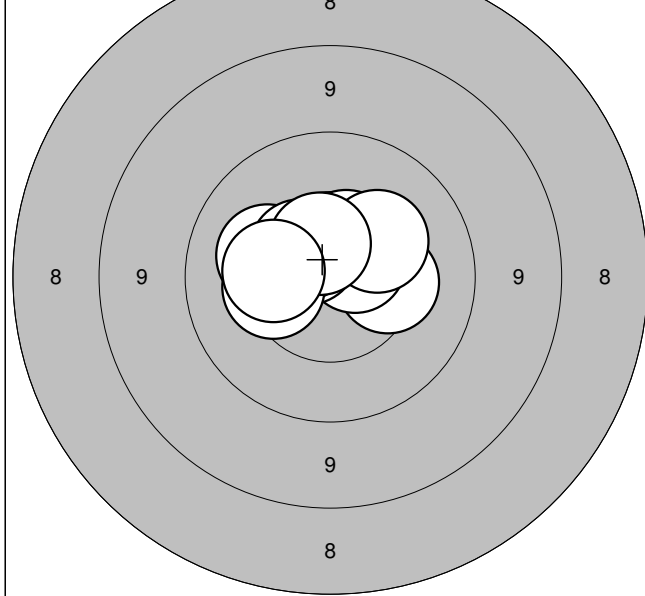

11:	10,5	↑
12:	10,3	↖
13:	10,3	→
14:	10,6*	↗
15:	10,6*	↗
16:	10,5	↗
17:	10,3	↗
18:	10,3	↖
19:	10,6	↑
20:	10,4	↖

Serie: **100,0**

Sum: **199,0**

Jyllandsstævne 2011

Hold

50

Bane

11

Kristine Rasmussen

Ulsted Skf.

ÅK1

Jyllandsstævne 2011 - riffel

Aalborg Skyttekreds

Prøveskud

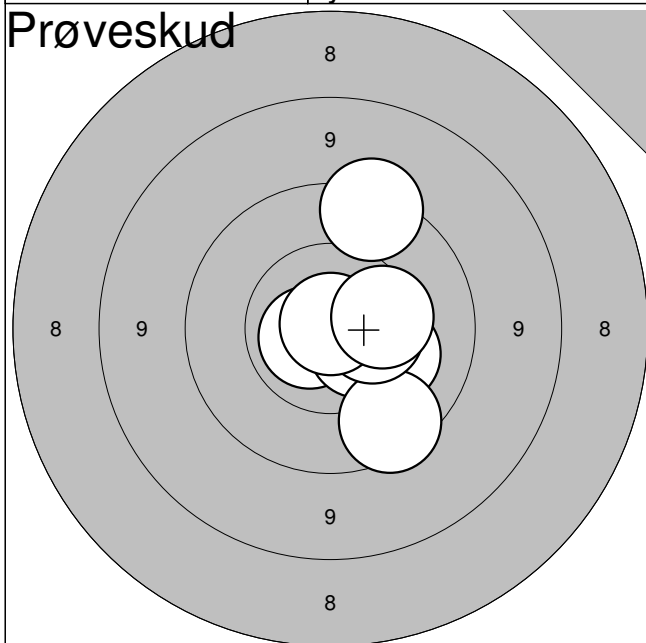

1:	10,7*	↙
2:	9,6	↑
3:	10,3	→
4:	10,6	↘
5:	9,8	↘
6:	10,5	→
7:	10,9*	↑
8:	10,4	→

Serie: 78,0

Sum: 0,0

Gældende

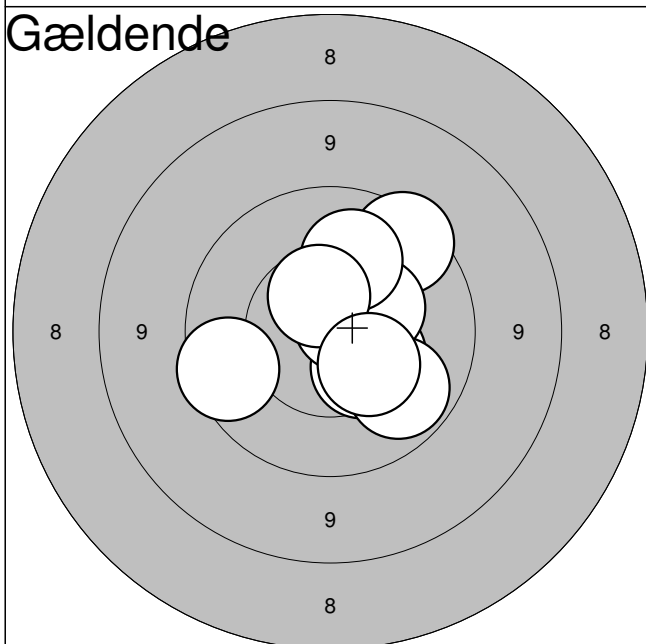

1:	10,4	↘
2:	10,4	↘
3:	10,8*	↗
4:	10,0	↘
5:	9,7	↗
6:	10,4	↗
7:	10,2	↑
8:	10,6	↑
9:	9,8	↙
10:	10,4	↘

Serie: 98,0

Sum: 98,0

Gældende

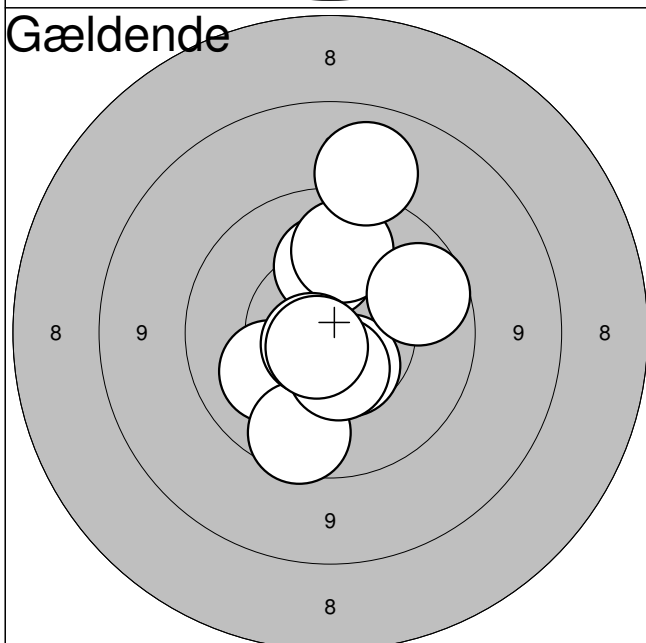

11:	10,2	↙
12:	9,8	↘
13:	10,2	↑
14:	10,1	↑
15:	10,5	↘
16:	10,6	↘
17:	9,2	↑
18:	10,7*	↙
19:	10,7*	↘
20:	9,9	→

Serie: 97,0

Sum: 195,0

Jyllandsstævne 2011



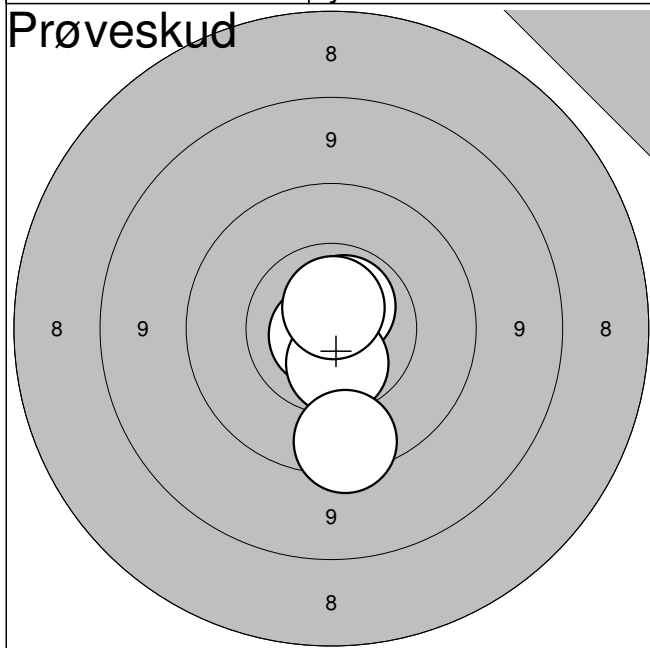

1:	10,8*	↙
2:	10,7*	↗
3:	10,6	↓
4:	9,7	↓
5:	10,7*	↑

**Serie: 49,0**

**Sum: 0,0**

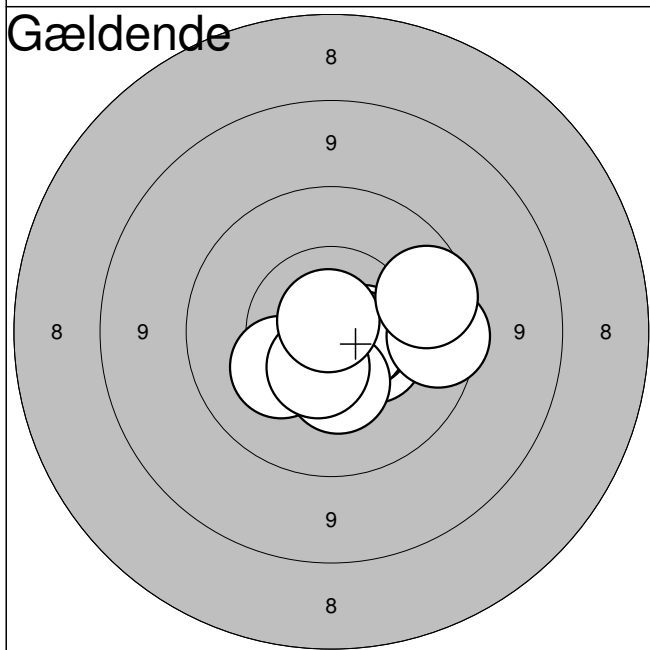

1:	10,5	↘
2:	10,3	↙
3:	10,9*	↓
4:	10,6*	→
5:	10,7*	↘
6:	10,4	↓
7:	10,5	↓
8:	9,8	→
9:	10,8*	↑
10:	9,9	→

**Serie: 98,0**

**Sum: 98,0**

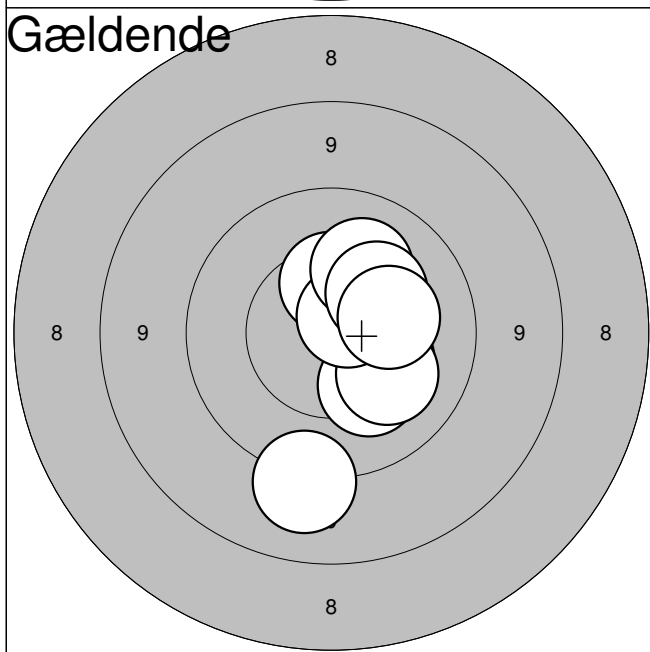

11:	10,3	↘
12:	10,3	↗
13:	10,4	↑
14:	10,3	↓
15:	9,3	↓
16:	10,2	↘
17:	10,7*	↗
18:	10,2	↗
19:	10,3	↗
20:	10,3	→

**Serie: 99,0**

**Sum: 197,0**



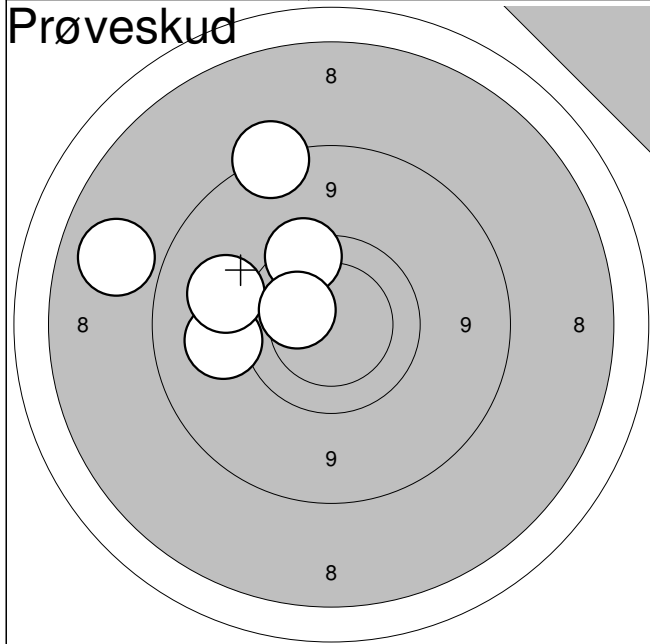

1:	8,7	↑
2:	9,3	←
3:	8,3	←
4:	9,7	↑
5:	9,3	←
6:	10,2	←

<b>Serie:</b>	<b>53,0</b>
<b>Sum:</b>	<b>0,0</b>

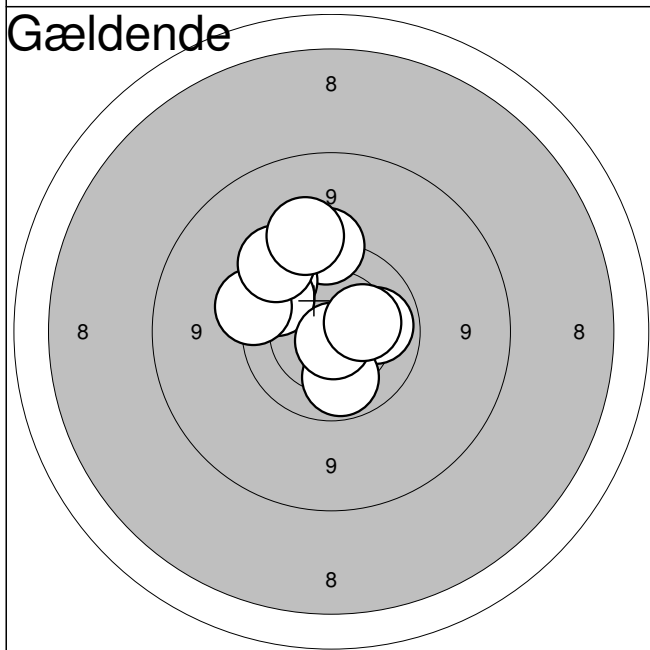

1:	9,6	↑
2:	10,1	→
3:	9,7	↗
4:	10,0	↓
5:	9,8	↗
6:	9,6	←
7:	10,8*	↓
8:	10,3	→
9:	9,5	↗
10:	9,4	↑

<b>Serie:</b>	<b>94,0</b>
<b>Sum:</b>	<b>94,0</b>

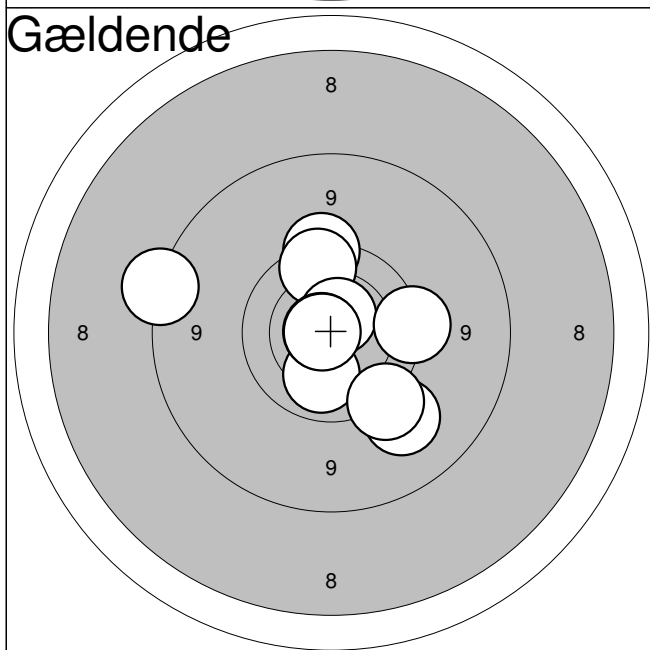

11:	9,6	↑
12:	9,8	↑
13:	10,1	↓
14:	10,6*	↑
15:	10,8*	←
16:	9,3	↓
17:	9,5	↓
18:	9,6	→
19:	8,7	←
20:	10,8*	←

<b>Serie:</b>	<b>93,0</b>
<b>Sum:</b>	<b>187,0</b>

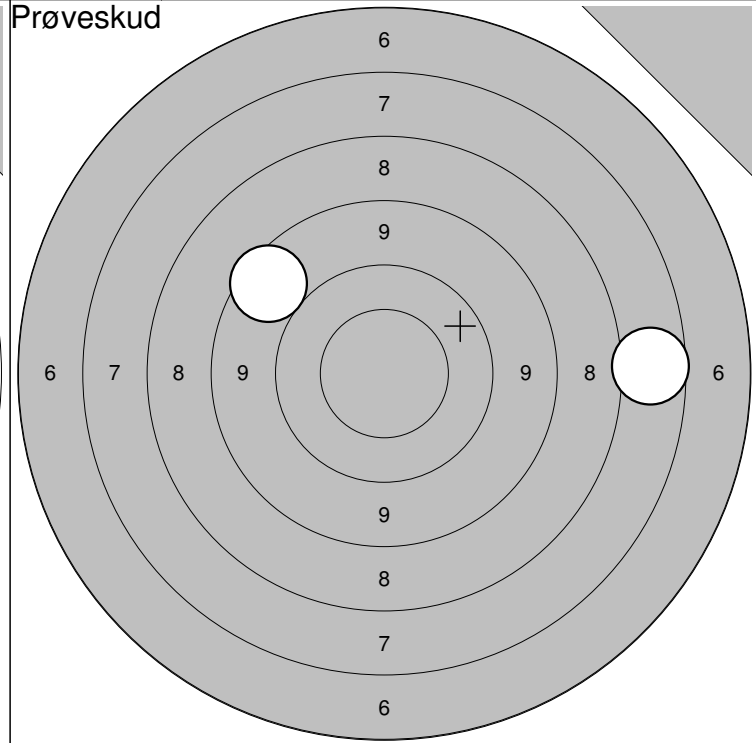
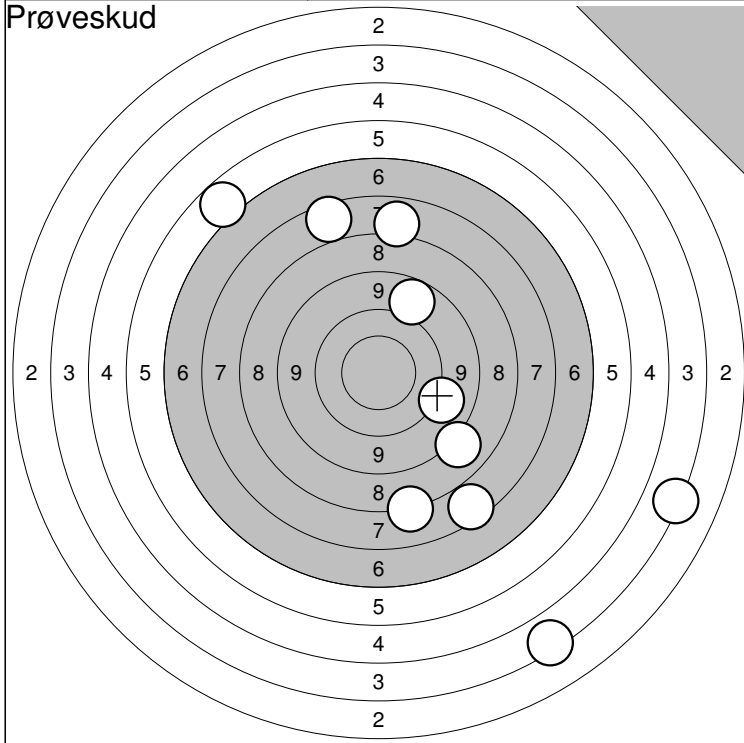

1: 9,0 ↗	6: 7,1 ↗	Serie: 61,0
2: 2,5 ↘	7: 5,0 ↗	
3: 2,6 ↘	8: 6,8 ↗	Sum: 0,0
4: 6,7 ↘	9: 9,2 ↘	
5: 8,2 ↘	10: 7,3 ↘	

11: 6,9 →	Serie: 14,0
12: 8,8 ↖	
	Sum: 0,0

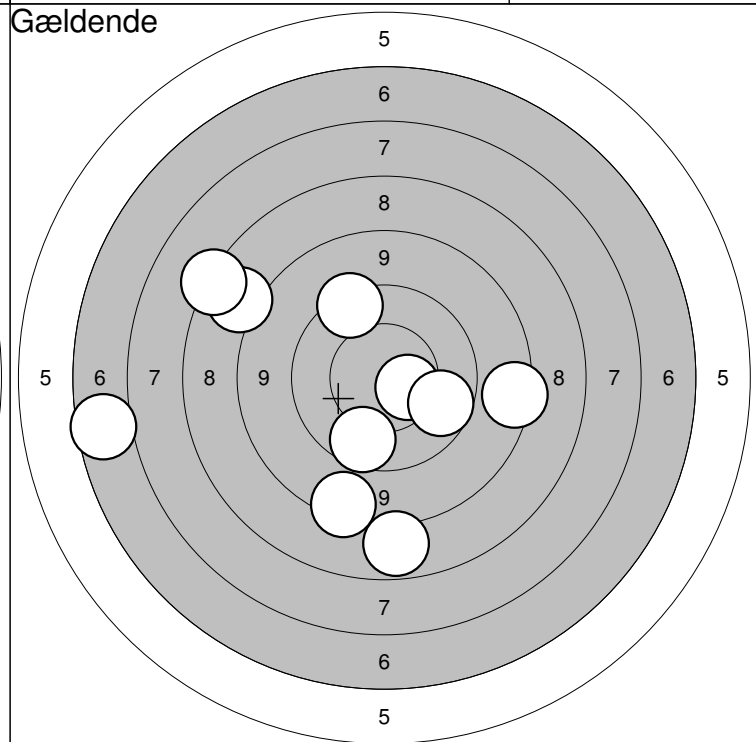
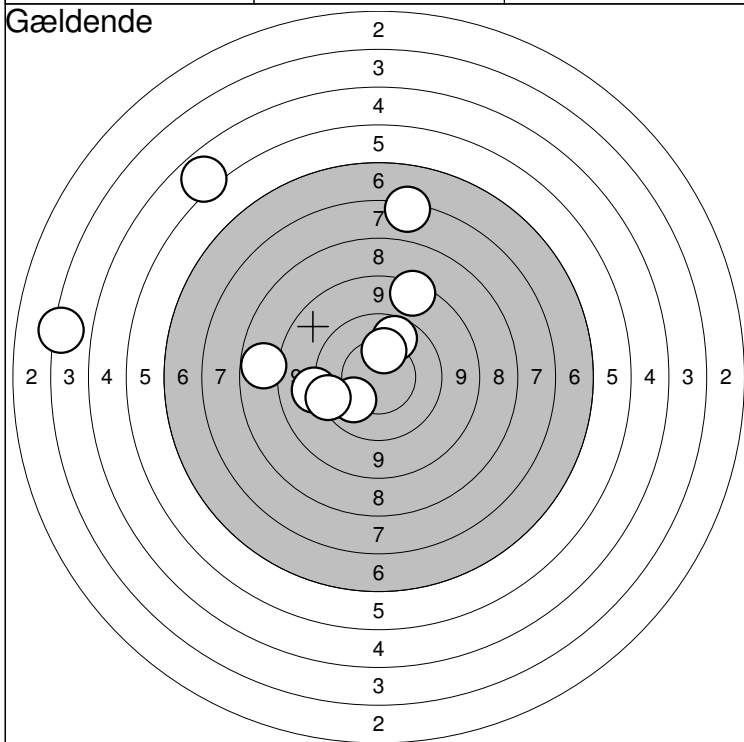

1: 8,7 ↗	6: 10,0 ↗	Serie: 76,0
2: 2,6 ←	7: 4,1 ↖	
3: 6,6 ↗	8: 9,3 ←	Sum: 76,0
4: 10,1 ↖	9: 9,6 ←	
5: 8,0 ←	10: 10,3 ↗	

11: 10,5 →	16: 8,1 ↖	Serie: 81,0
12: 8,6 →	17: 9,9 ↘	
13: 8,0 ↘	18: 7,5 ↖	Sum: 157,0
14: 8,6 ↘	19: 9,6 ↗	
15: 9,9 →	20: 5,9 ←	

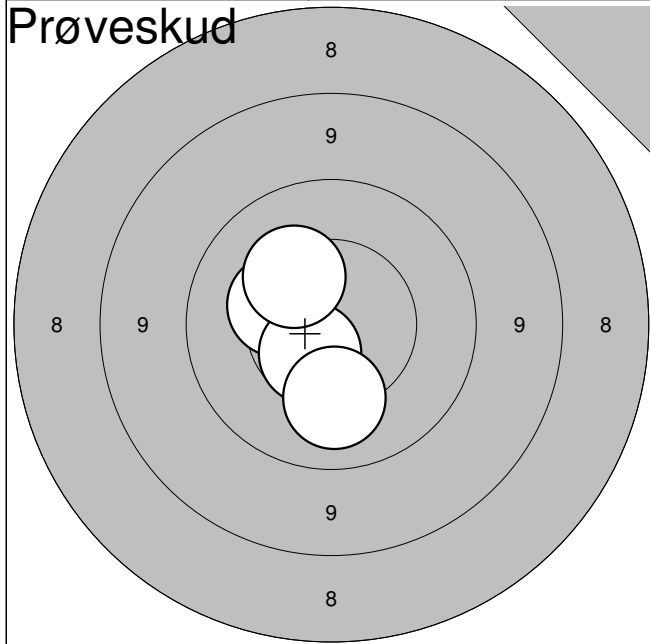

1:	10,4	↖
2:	10,6	↘
3:	10,2	↓
4:	10,3	↗

<b>Serie:</b>	<b>40,0</b>
<b>Sum:</b>	<b>0,0</b>

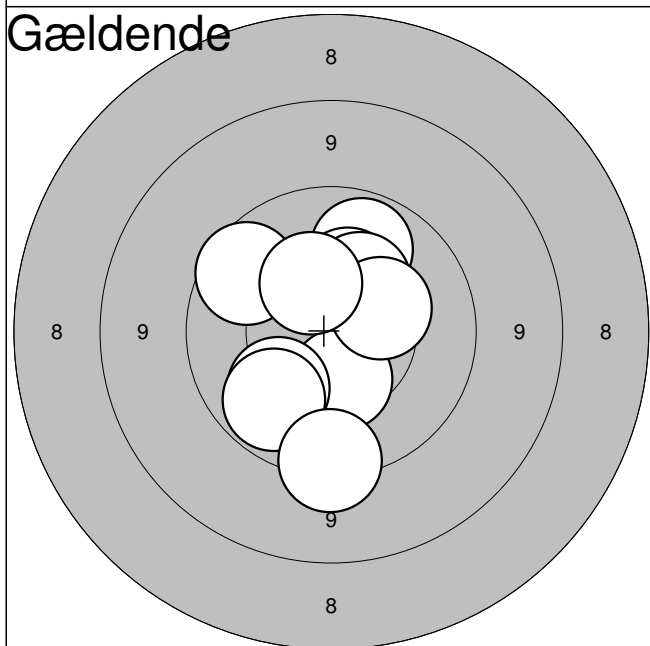

1:	10,0	↑
2:	10,4	↓
3:	10,4	↑
4:	10,4	↗
5:	10,4	→
6:	9,9	↖
7:	10,4	↑
8:	10,1	↘
9:	10,0	↘
10:	9,5	↓

<b>Serie:</b>	<b>98,0</b>
<b>Sum:</b>	<b>98,0</b>

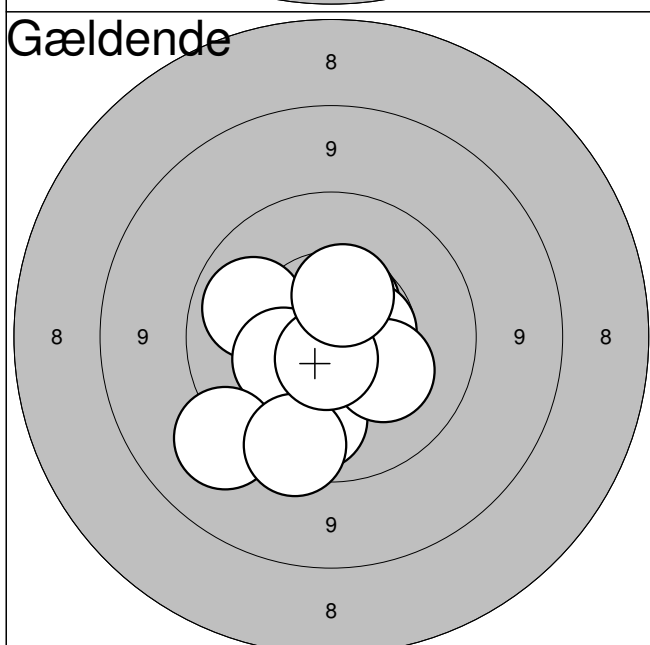

11:	10,1	↓
12:	10,1	↖
13:	10,4	↖
14:	10,6	↗
15:	9,3	↘
16:	10,6	→
17:	9,7	↓
18:	10,3	↘
19:	10,7*	↓
20:	10,5	↑

<b>Serie:</b>	<b>98,0</b>
<b>Sum:</b>	<b>196,0</b>

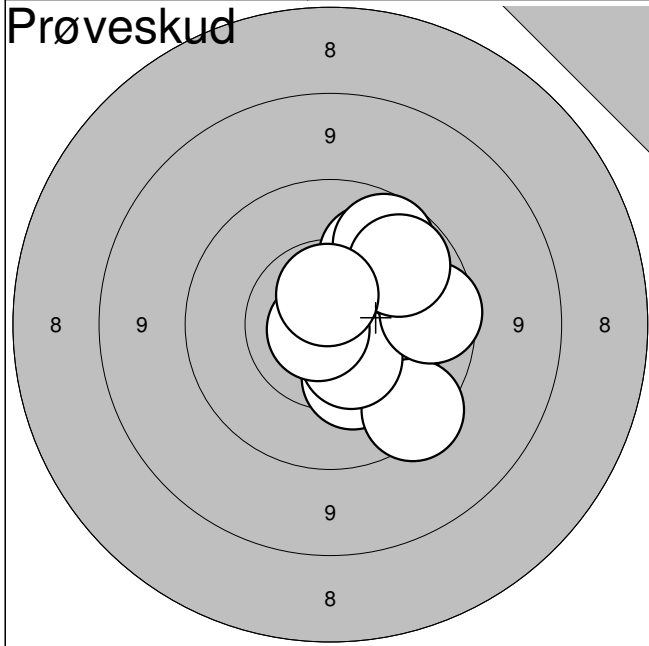

1:	10,1	→
2:	10,3	↓
3:	9,7	↓
4:	10,1	↑
5:	10,5	↓
6:	9,9	↑
7:	9,9	→
8:	10,8*	←
9:	10,0	↗
10:	10,6*	↑

**Serie: 97,0**

**Sum: 0,0**

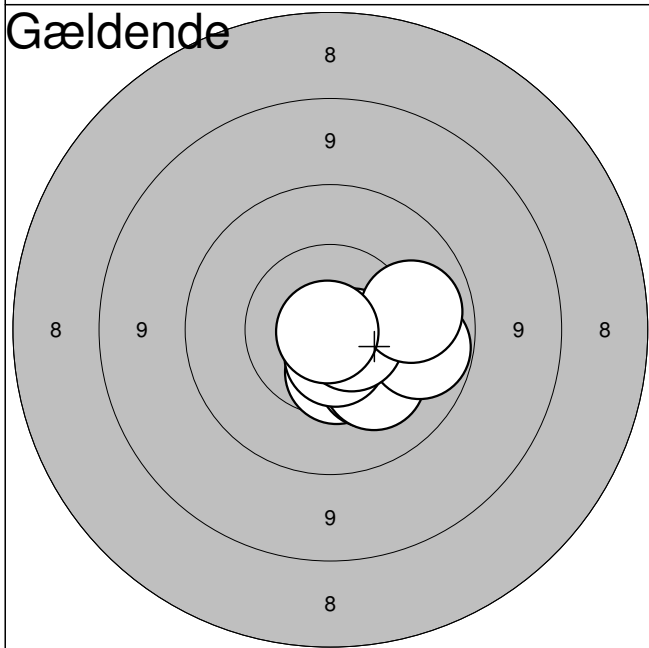

1:	10,5	↓
2:	10,2	→
3:	10,3	↓
4:	10,2	↓
5:	10,1	→
6:	10,0	→
7:	10,7*	↓
8:	10,7*	→
9:	10,1	→
10:	10,9*	↓

**Serie: 100,0**

**Sum: 100,0**

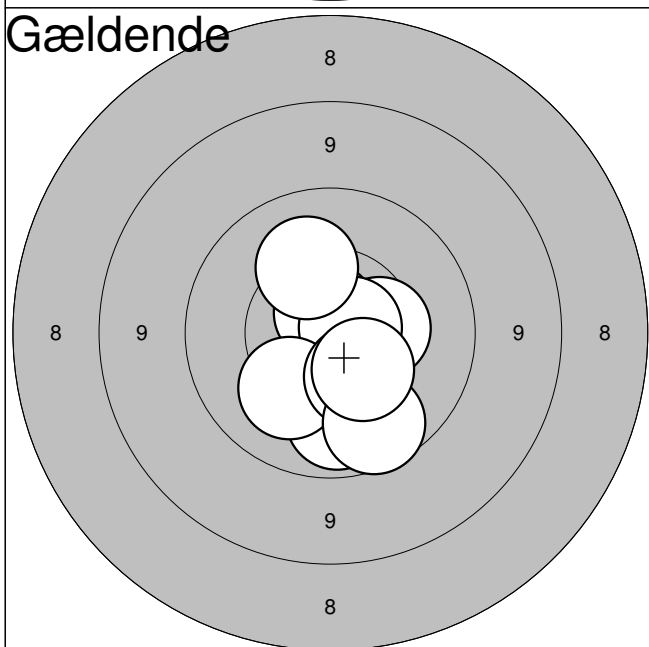

11:	10,7*	↑
12:	10,5	↓
13:	10,4	→
14:	10,0	↓
15:	10,7*	→
16:	10,2	↓
17:	10,4	↓
18:	9,9	↓
19:	10,4	↓
20:	10,2	↑

**Serie: 99,0**

**Sum: 199,0**

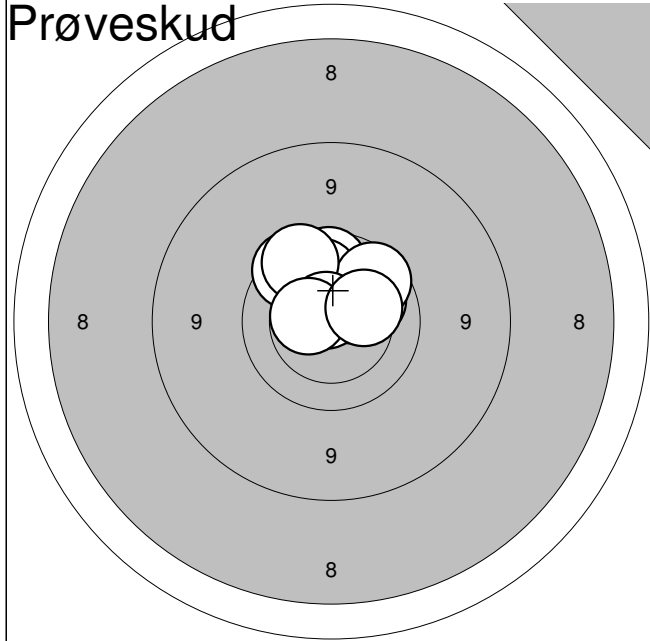

1:	10,1	↗
2:	9,9	↑
3:	10,5	↗
4:	10,1	↑
5:	9,8	↗
6:	9,9	↗
7:	9,8	↗
8:	10,7*	↑
9:	10,5*	↖
10:	10,3	↗

<b>Serie:</b>	<b>96,0</b>
---------------	-------------

<b>Sum:</b>	<b>0,0</b>
-------------	------------

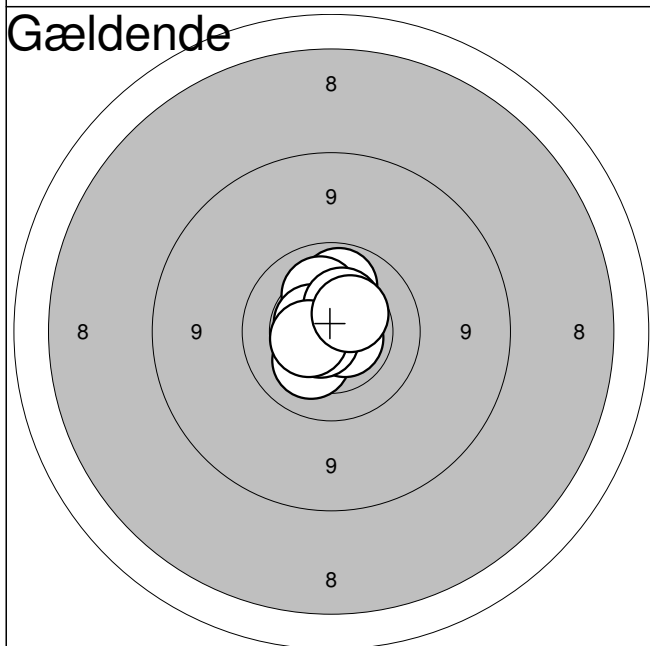

1:	10,1	↑
2:	10,2	↑
3:	10,3	↘
4:	10,6*	↖
5:	10,7*	↗
6:	10,6*	↘
7:	10,4	↑
8:	10,7*	↘
9:	10,5*	↖
10:	10,4	↗

<b>Serie:</b>	<b>100,0</b>
---------------	--------------

<b>Sum:</b>	<b>100,0</b>
-------------	--------------

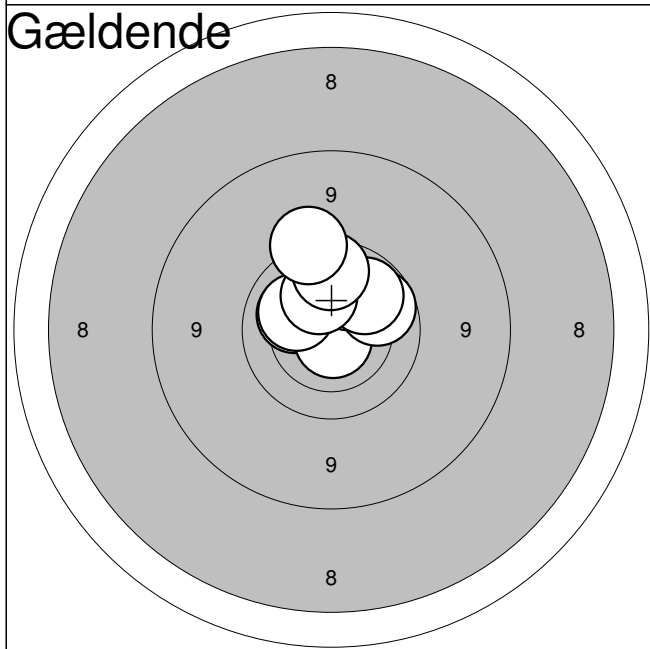

11:	10,2	↖
12:	10,8*	↑
13:	10,7*	↘
14:	10,1	↑
15:	10,2	↖
16:	9,9	↗
17:	10,0	↗
18:	10,3	↑
19:	9,9	↑
20:	9,6	↑

<b>Serie:</b>	<b>97,0</b>
---------------	-------------

<b>Sum:</b>	<b>197,0</b>
-------------	--------------

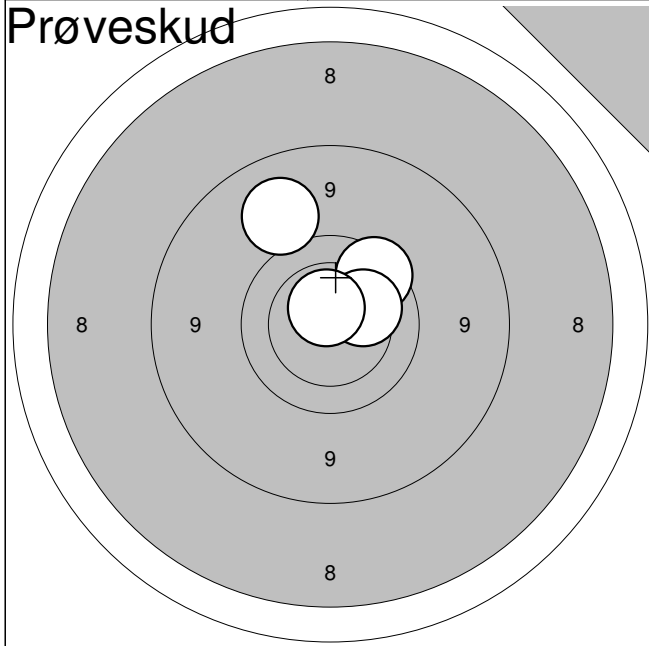

1:	9,8	↗
2:	10,2	→
3:	9,2	↗
4:	10,6*	↗

<b>Serie:</b>	<b>38,0</b>
<b>Sum:</b>	<b>0,0</b>

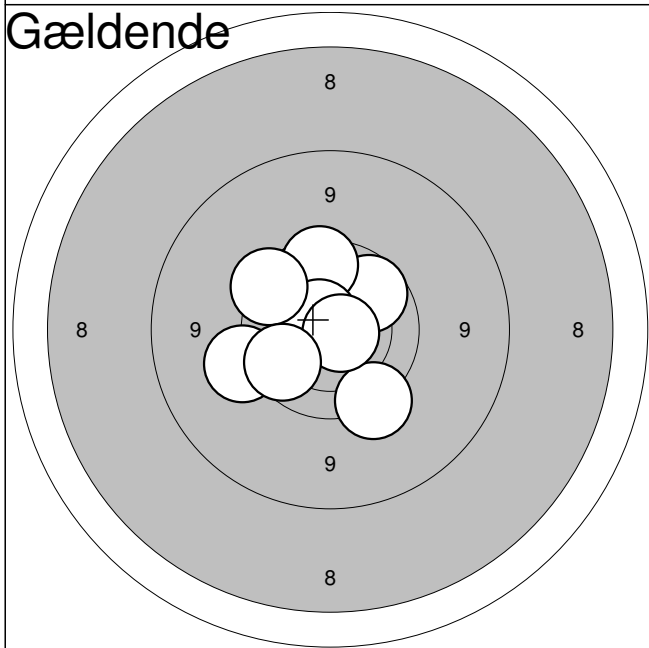

1:	9,9	↗
2:	9,9	→
3:	9,9	↗
4:	9,8	↗
5:	10,6*	↗
6:	9,6	↘
7:	9,7	↗
8:	10,7*	→
9:	9,5	↖
10:	9,9	↘

<b>Serie:</b>	<b>92,0</b>
<b>Sum:</b>	<b>92,0</b>

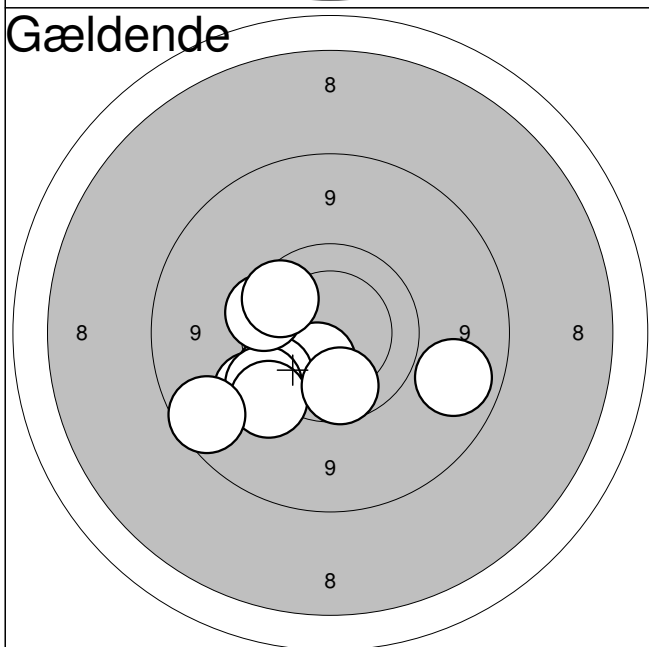

11:	10,3	↘
12:	9,7	↖
13:	9,4	↖
14:	9,6	↖
15:	9,5	↘
16:	9,9	↘
17:	8,9	↖
18:	9,8	↖
19:	9,1	→
20:	9,9	↗

<b>Serie:</b>	<b>90,0</b>
<b>Sum:</b>	<b>182,0</b>

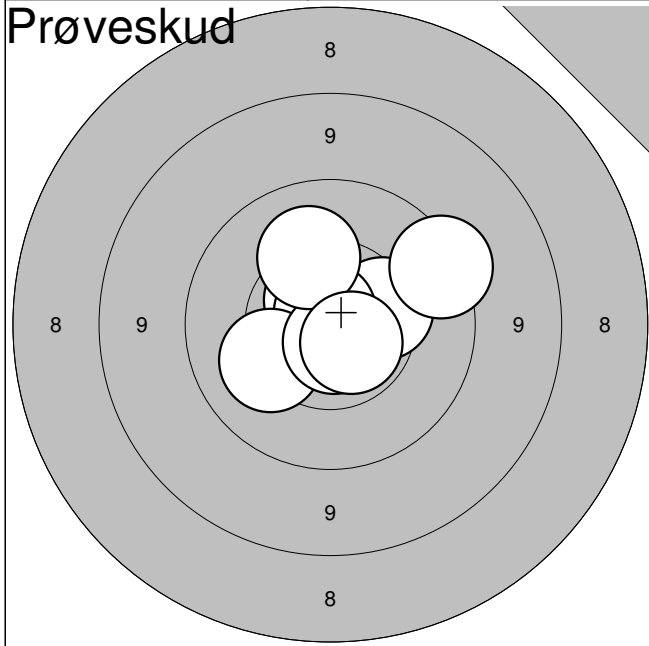

1:	10,7*	↗
2:	10,4	→
3:	10,8*	↗
4:	10,2	↖
5:	9,6	→
6:	10,8*	↘
7:	10,2	↗
8:	10,7*	↘

<b>Serie:</b>	<b>79,0</b>
<b>Sum:</b>	<b>0,0</b>

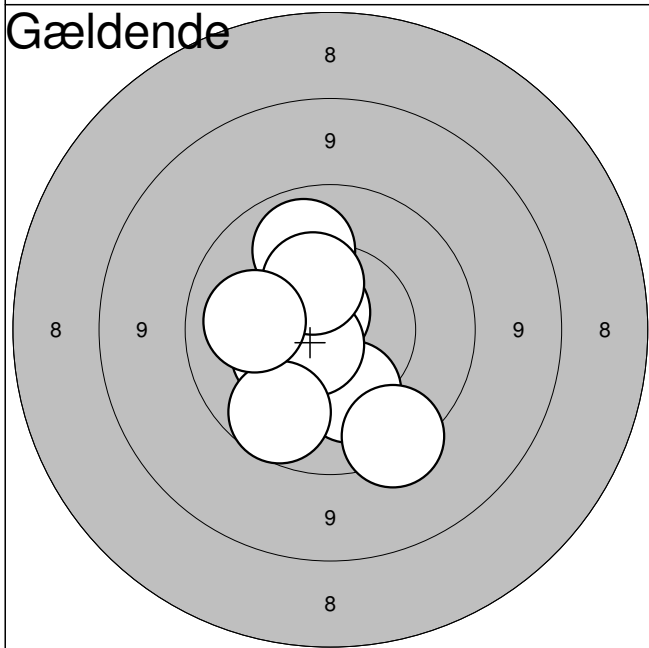

1:	10,4	←
2:	10,7*	↗
3:	10,1	↗
4:	10,3	↘
5:	10,4	↖
6:	10,7*	↖
7:	10,4	↗
8:	9,6	↘
9:	9,9	↘
10:	10,1	←

<b>Serie:</b>	<b>98,0</b>
<b>Sum:</b>	<b>98,0</b>

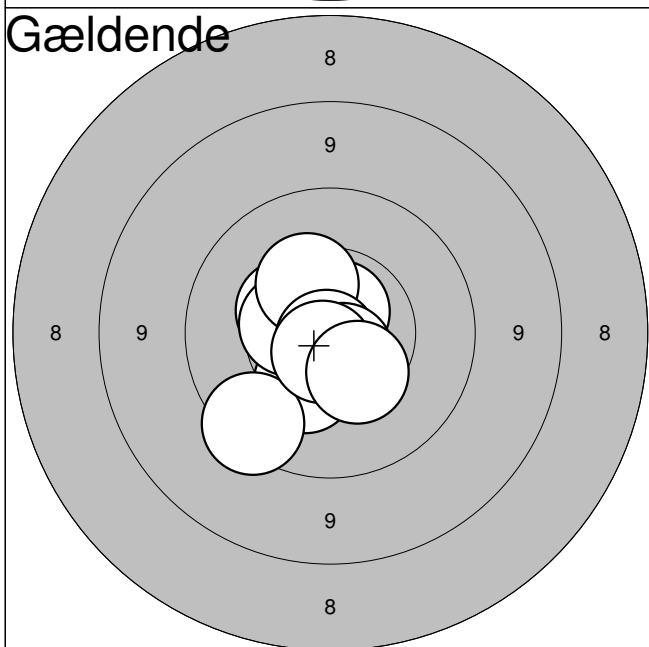

11:	10,4	↘
12:	10,7*	↗
13:	10,4	↖
14:	10,5	←
15:	10,4	↗
16:	10,8*	↘
17:	9,7	↖
18:	10,7*	↘
19:	10,7*	↘
20:	10,4	↘

<b>Serie:</b>	<b>99,0</b>
<b>Sum:</b>	<b>197,0</b>

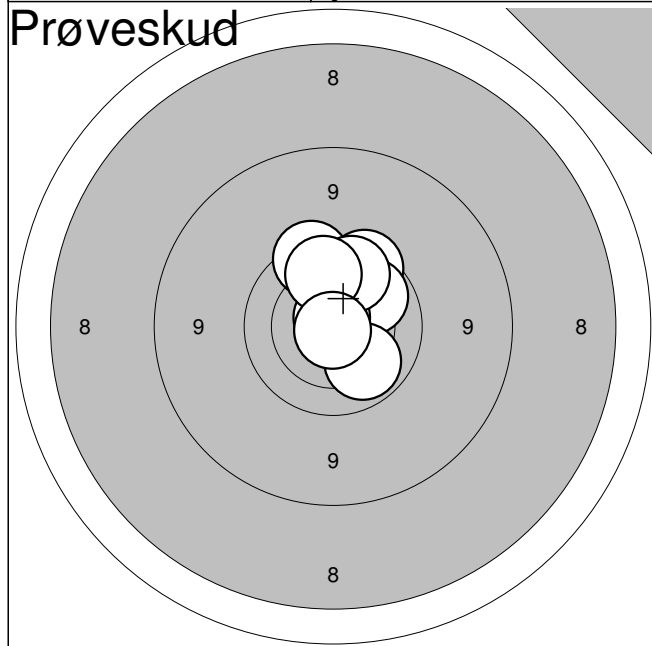

1:	9,8	↗
2:	9,7	↑
3:	10,0	↗
4:	10,8*	↑
5:	10,0	↘
6:	9,9	↑
7:	9,9	↑
8:	10,9*	↓

<b>Serie:</b>	<b>76,0</b>
<b>Sum:</b>	<b>0,0</b>

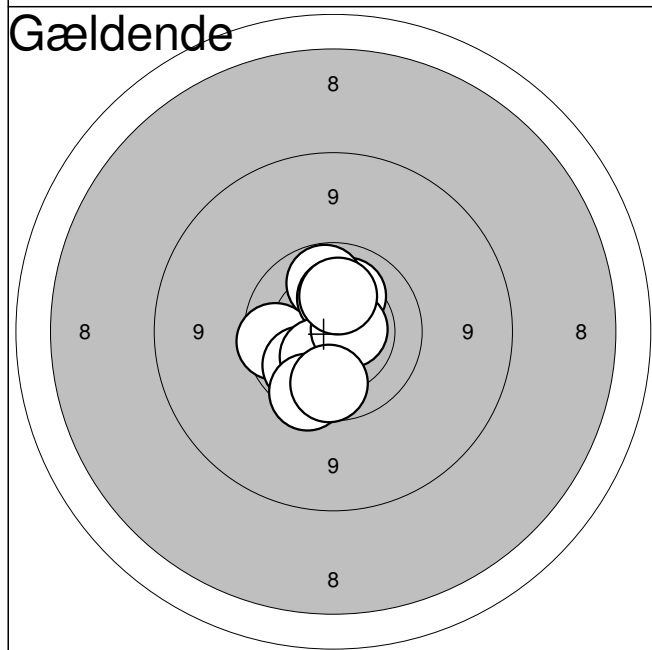

1:	10,2	↗
2:	10,0	↑
3:	9,9	←
4:	10,3	↑
5:	10,0	↘
6:	10,4	↘
7:	10,6*	→
8:	9,8	↘
9:	9,9	↓
10:	10,3	↑

<b>Serie:</b>	<b>97,0</b>
<b>Sum:</b>	<b>97,0</b>

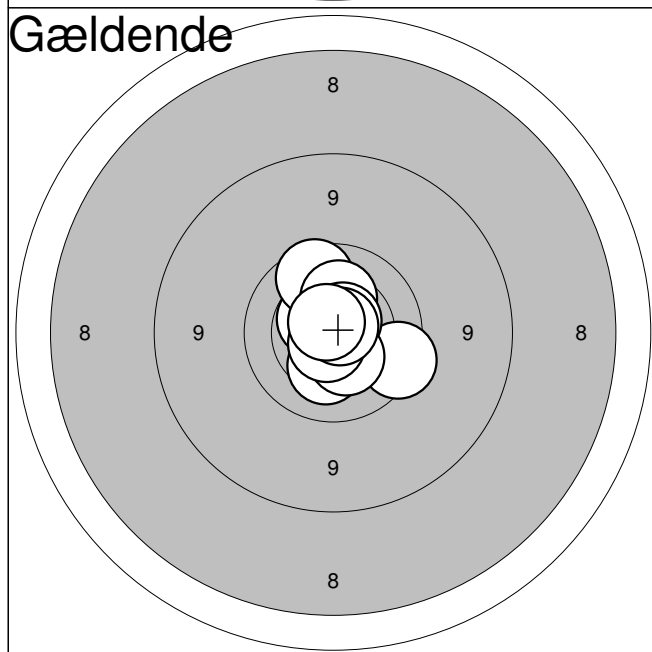

11:	10,5*	↗
12:	9,9	↑
13:	10,3	↑
14:	9,7	↘
15:	10,7*	↗
16:	10,3	↘
17:	10,4	↘
18:	10,7*	↘
19:	10,8*	↗
20:	10,7*	↑

<b>Serie:</b>	<b>98,0</b>
<b>Sum:</b>	<b>195,0</b>



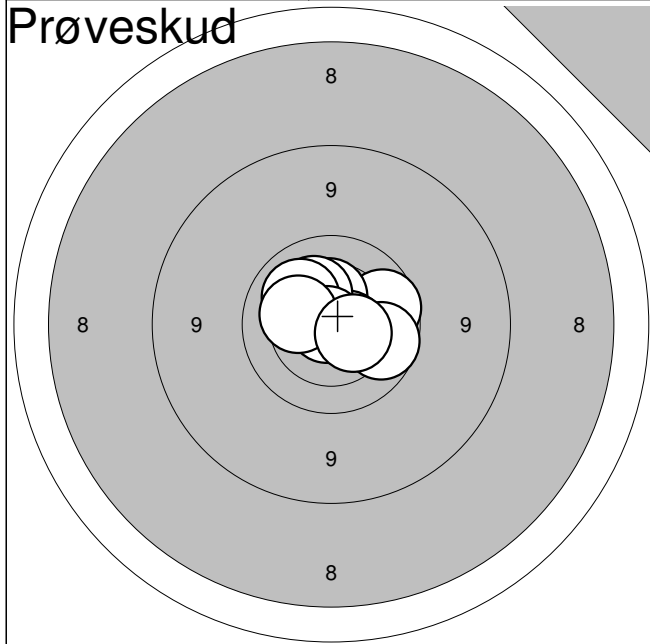

1:	9,9	→
2:	10,4	↑
3:	10,6*	→
4:	10,3	↗
5:	10,2	↗
6:	10,9*	←
7:	9,9	→
8:	10,3	↖
9:	10,5	↘

<b>Serie:</b>	<b>88,0</b>
<b>Sum:</b>	<b>0,0</b>

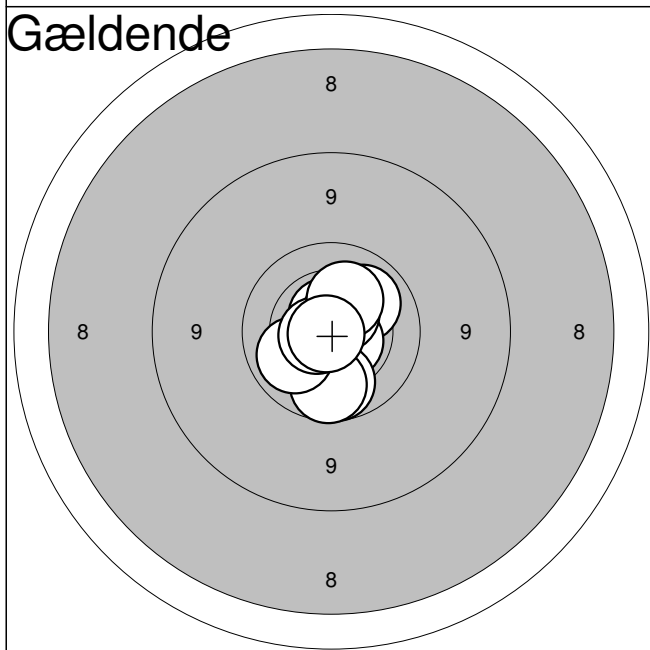

1:	10,1	↗
2:	10,6*	↘
3:	10,0	↓
4:	10,7*	↑
5:	9,9	↓
6:	10,6*	↗
7:	10,1	↖
8:	10,7*	←
9:	10,3	↑
10:	10,8*	↖

<b>Serie:</b>	<b>99,0</b>
<b>Sum:</b>	<b>99,0</b>

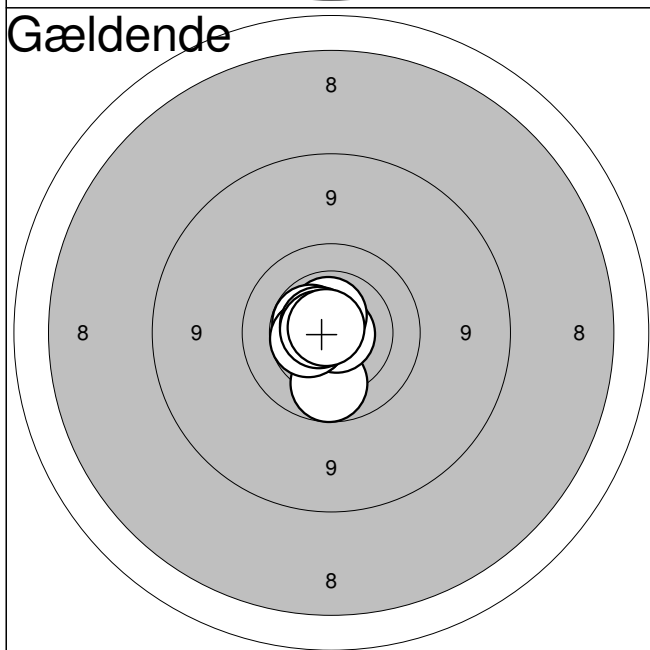

11:	10,0	↓
12:	10,8*	→
13:	10,6*	↑
14:	10,5*	↖
15:	10,5*	←
16:	10,5*	←
17:	10,7*	↖
18:	10,7*	↗
19:	10,7*	←
20:	10,8*	↗

<b>Serie:</b>	<b>100,0</b>
<b>Sum:</b>	<b>199,0</b>

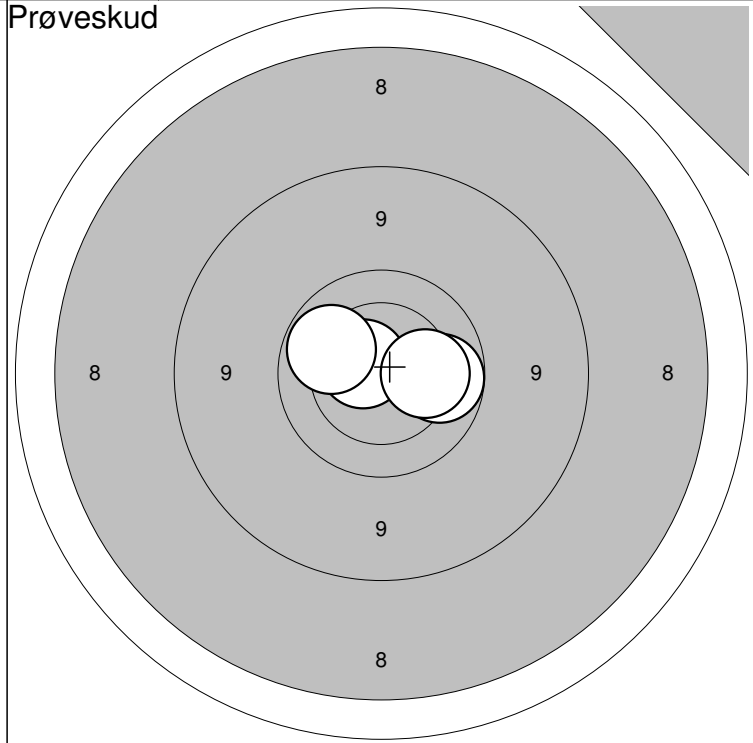
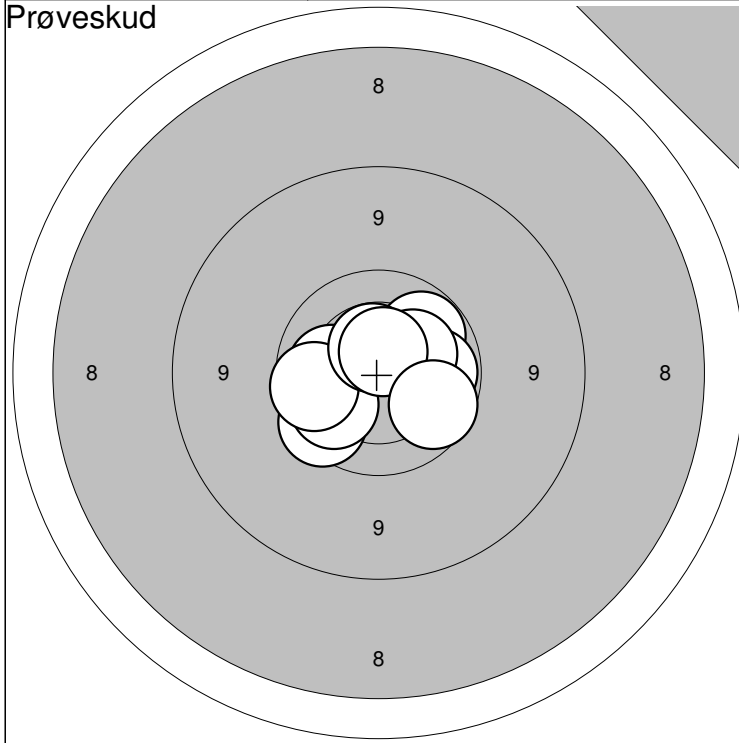

1: 9,8 ↙	6:10,5* ↑	<b>Serie:</b> 97,0	
2:10,2 ←	7:10,0 →		
3:10,0 ↙	8:10,3 ↗	<b>Sum:</b> 0,0	
4: 9,9 ←	9:10,6* ↑		
5:10,0 ↗	10: 9,9 ↘		

11:10,6* ↖	<b>Serie:</b> 40,0
12:10,0 →	
13:10,0 ↖	<b>Sum:</b> 0,0
14:10,2 →	

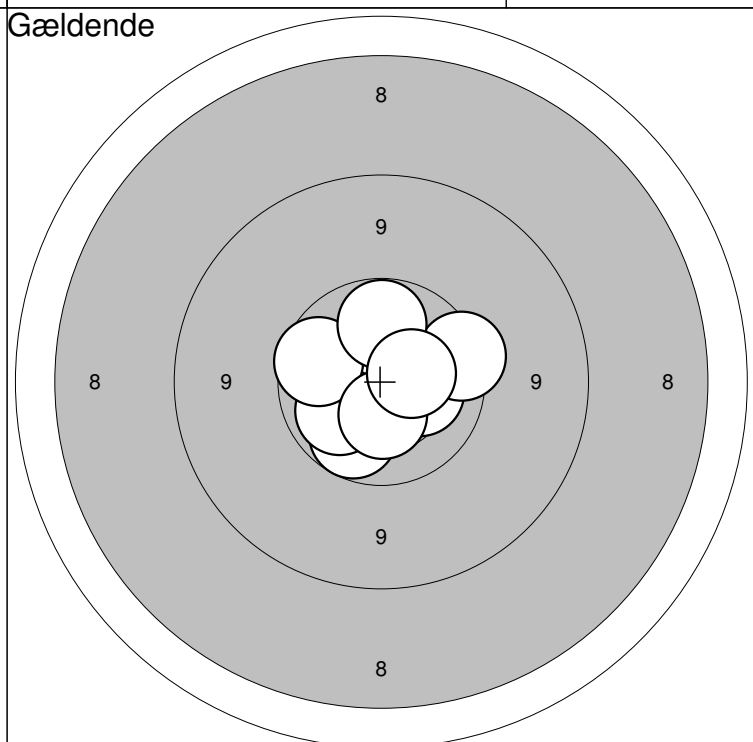
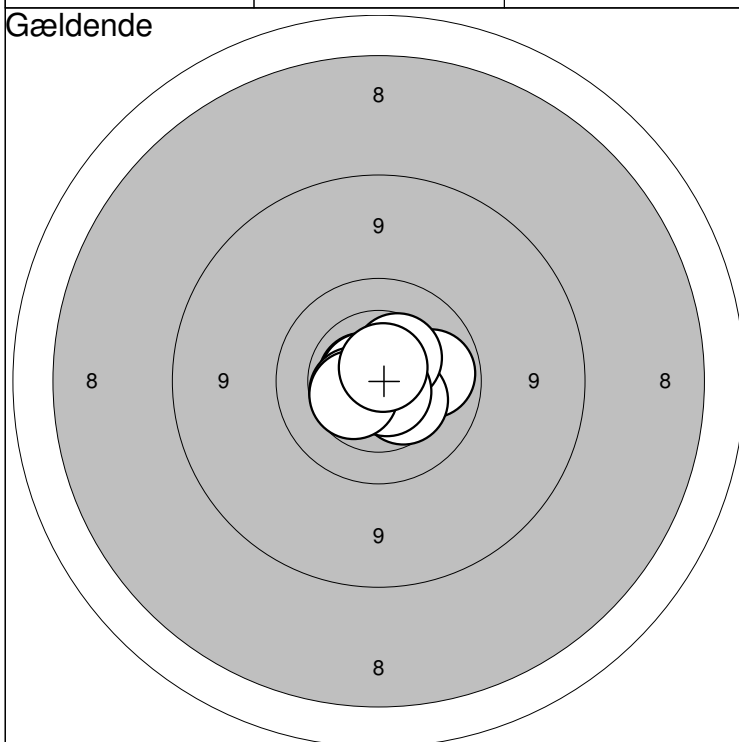

1:10,5* →	6:10,7* ←	<b>Serie:</b> 100,0	
2:10,0 →	7:10,5* ←		
3:10,4 ↘	8:10,7* ↘	<b>Sum:</b> 100,0	
4:10,4 ↗	9:10,5 ←		
5:10,7* ←	10:10,7* ↑		

11:10,3 →	16: 9,9 ←	<b>Serie:</b> 97,0
12:10,6* ←	17:10,4 ↓	
13:10,5* ↖	18: 9,7 →	<b>Sum:</b> 197,0
14: 9,9 ↓	19:10,0 ↑	
15:10,1 ←	20:10,4 →	

Horsens-Hammer Skf.

J2

Jyllandsstævne 2011 - riffel

Aalborg Skyttekreds

**Prøveskud**

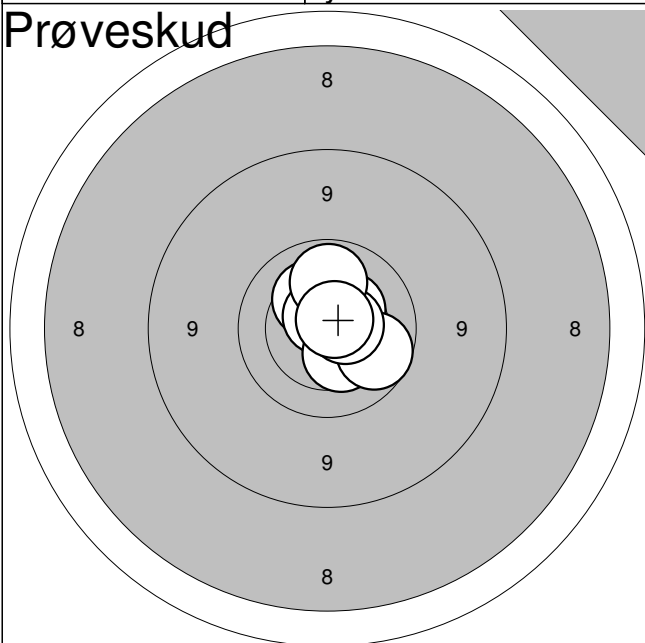

1:	10,3	↗
2:	10,7*	↗
3:	10,4	↗
4:	10,4	↘
5:	9,9	↘
6:	10,6*	→
7:	10,0	↑
8:	10,7*	↗

Serie: 79,0

Sum: 0,0

**Gældende**

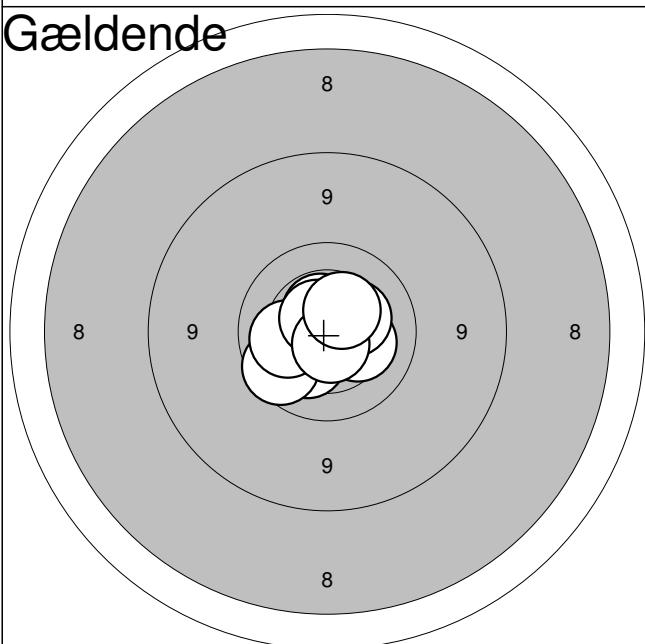

1:	10,3	↘
2:	9,9	↘
3:	10,8*	↘
4:	10,2	←
5:	10,6*	↑
6:	10,3	↘
7:	10,6*	↗
8:	10,4	↗
9:	10,7*	↘
10:	10,4	↗

Serie: 99,0

Sum: 99,0

**Gældende**

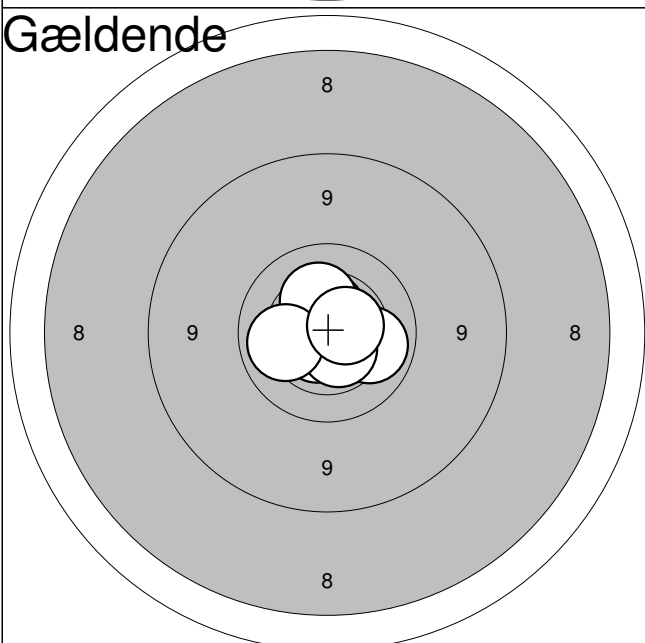

11:	10,7*	↑
12:	10,7*	↘
13:	10,7*	↗
14:	10,1	↘
15:	10,7*	↖
16:	10,6*	↘
17:	10,5*	↑
18:	10,3	↑
19:	10,1	←
20:	10,6*	→

Serie: 100,0

Sum: 199,0

Hold

52

Bane

2

Ole Nielsen

Vilsted Skf.

V3

Jyllandsstævne 2011 - riffel

Aalborg Skyttekreds

Prøveskud

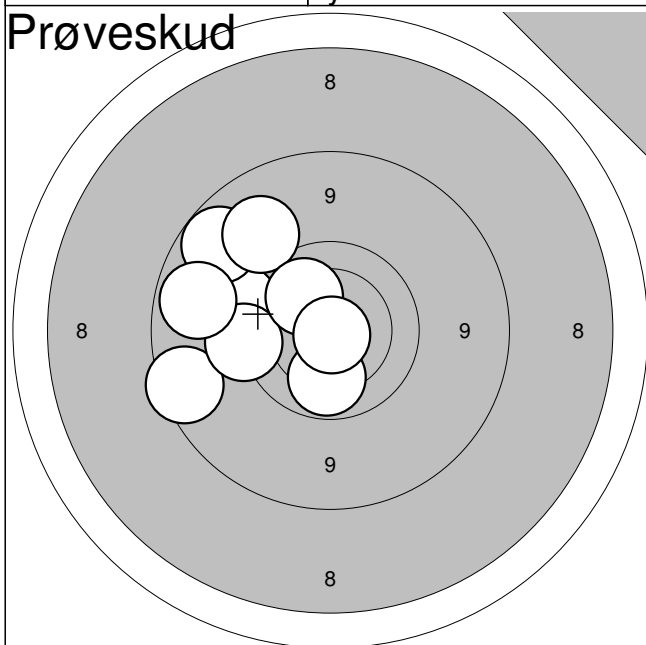

1:	8,8	←
2:	10,0	↓
3:	9,5	←
4:	9,0	↗
5:	9,2	↗
6:	9,5	←
7:	9,0	←
8:	10,1	↗
9:	10,8*	↓

Serie: 83,0

Sum: 0,0

Gældende

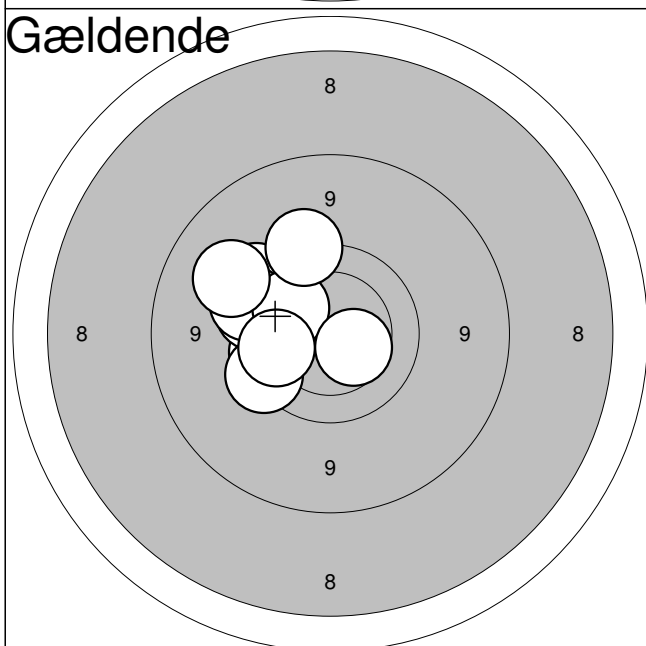

1:	9,5	↗
2:	9,8	←
3:	9,6	←
4:	9,7	←
5:	9,5	←
6:	10,0	↗
7:	9,9	←
8:	9,3	↗
9:	10,4	↓
10:	9,5	↗

Serie: 92,0

Sum: 92,0

Gældende

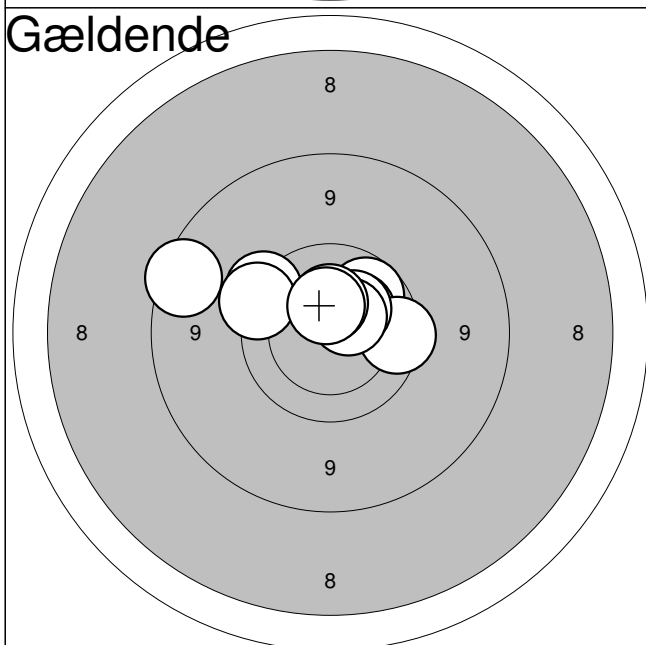

11:	9,9	↗
12:	10,3	↗
13:	9,8	→
14:	9,6	↗
15:	10,3	↗
16:	10,5	↗
17:	9,6	←
18:	10,4	↑
19:	10,4	↑
20:	8,8	←

Serie: 94,0

Sum: 186,0

Jyllandsstævne 2011

Hold

52

Bane

3

## Morten Aagaard Christensen

Vilsted Skf.

ÅK2

Jyllandsstævne 2011 - riffel

Aalborg Skyttekreds

## Prøveskud

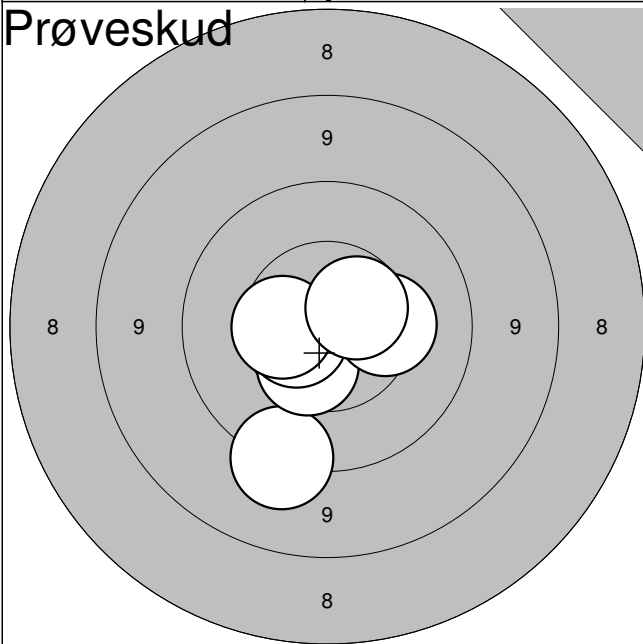

1: 9,4



2: 10,5



3: 10,6\*



4: 10,5



5: 10,3



6: 10,6



Serie: 59,0

Sum: 0,0

## Gældende

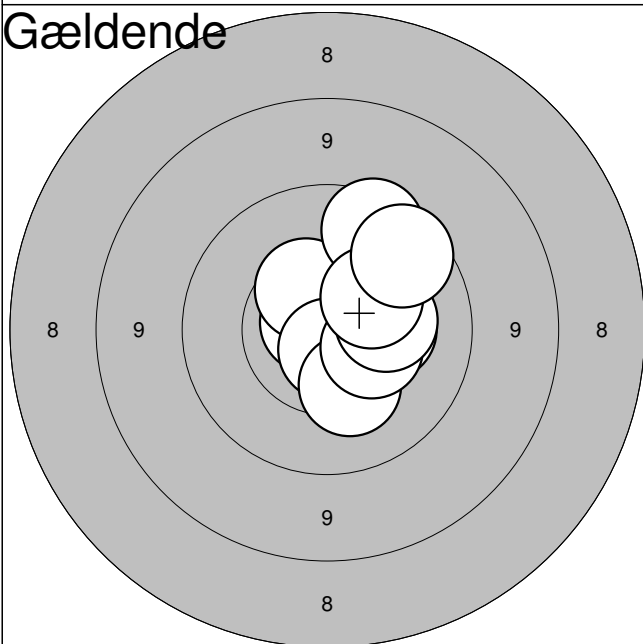

1: 10,8\*



2: 10,3



3: 10,5



4: 9,8



5: 10,7\*



6: 10,3



7: 10,4



8: 10,3



9: 10,4



10: 9,8



Serie: 98,0

Sum: 98,0

## Gældende

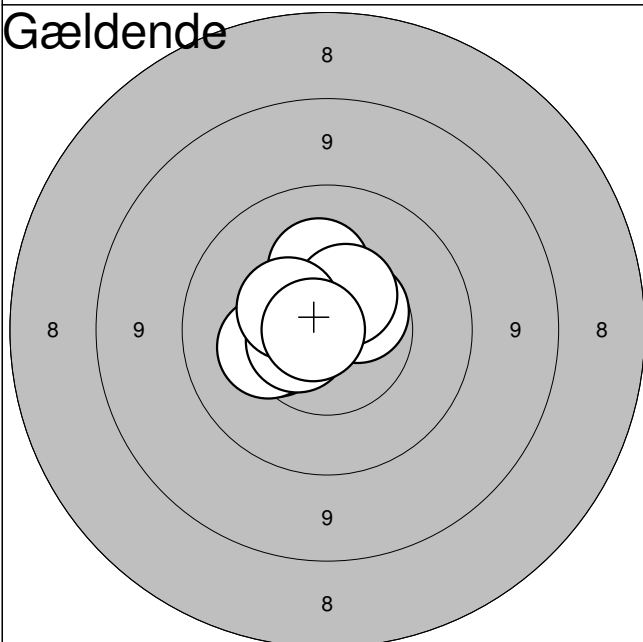

11: 10,4



12: 10,3



13: 10,7\*



14: 10,6\*



15: 10,7\*



16: 10,3



17: 10,6



18: 10,5



19: 10,5



20: 10,8\*



Serie: 100,0

Sum: 198,0

Jyllandsstævne 2011

Hold

52

Bane

4

Christian S. Nielsen

Vilsted Skf.

BK3

Jyllandsstævne 2011 - riffel

Aalborg Skyttekreds

Prøveskud

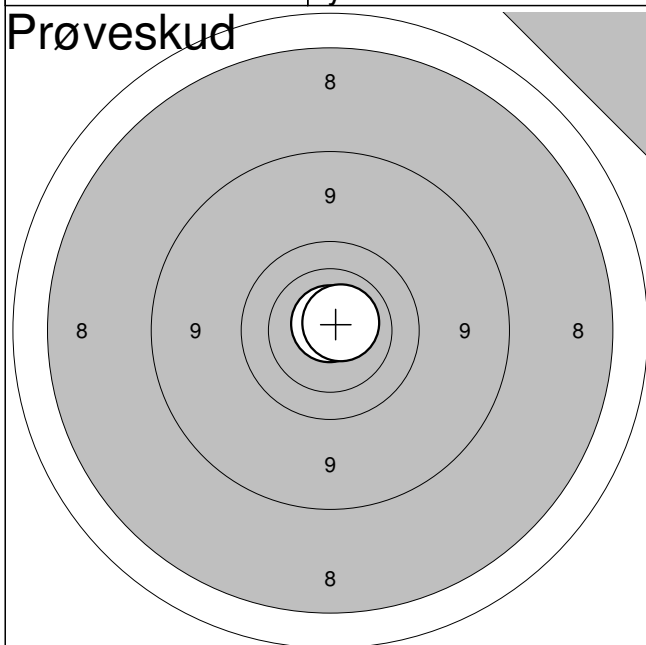

1: 10,8\*

↑

2: 10,7\*

↗

Serie: 20,0

Sum: 0,0

Gældende

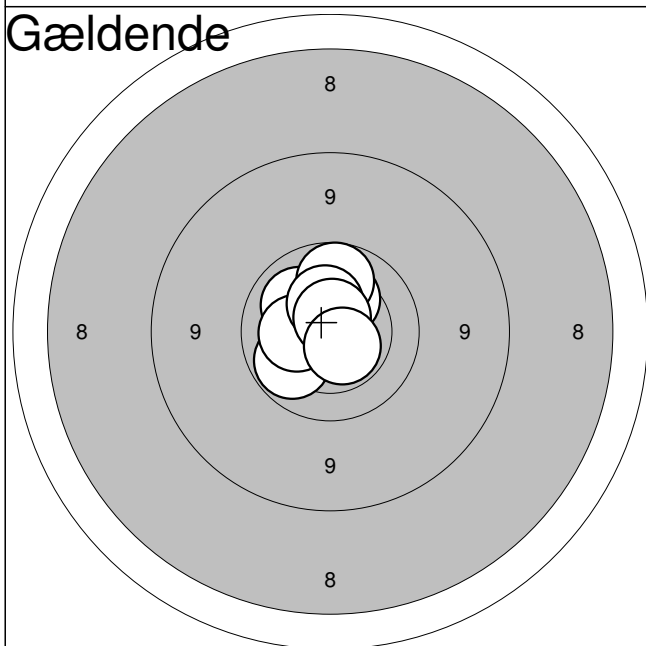

1: 10,2

↖

2: 10,3

↑

3: 10,4

↖

4: 10,0

↖

5: 10,8\*

↑

6: 10,3

←

7: 10,0

↑

8: 10,4

↑

9: 10,7\*

↑

10: 10,6\*

↘

Serie: 100,0

Sum: 100,0

Gældende

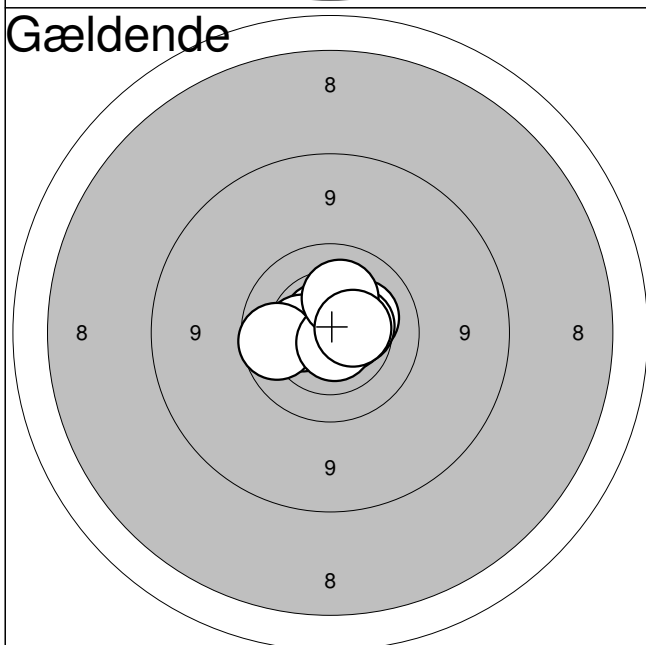

11: 10,7\*

↖

12: 10,7\*

↑

13: 10,4

←

14: 9,9

←

15: 10,3

↗

16: 10,6\*

→

17: 10,7\*

↘

18: 10,4

→

19: 10,3

↑

20: 10,5\*

→

Serie: 99,0

Sum: 199,0

Jyllandsstævne 2011

Hold

52

Bane

6

Charlotte Larsen

Vilsted Skf.

ÅK2

Jyllandsstævne 2011 - riffel

Aalborg Skyttekreds

Prøveskud

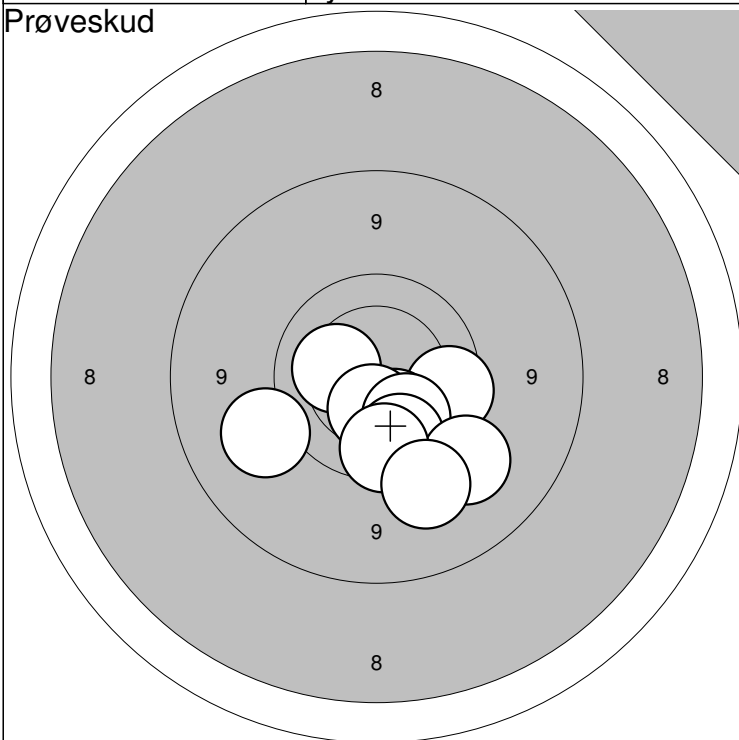

Prøveskud

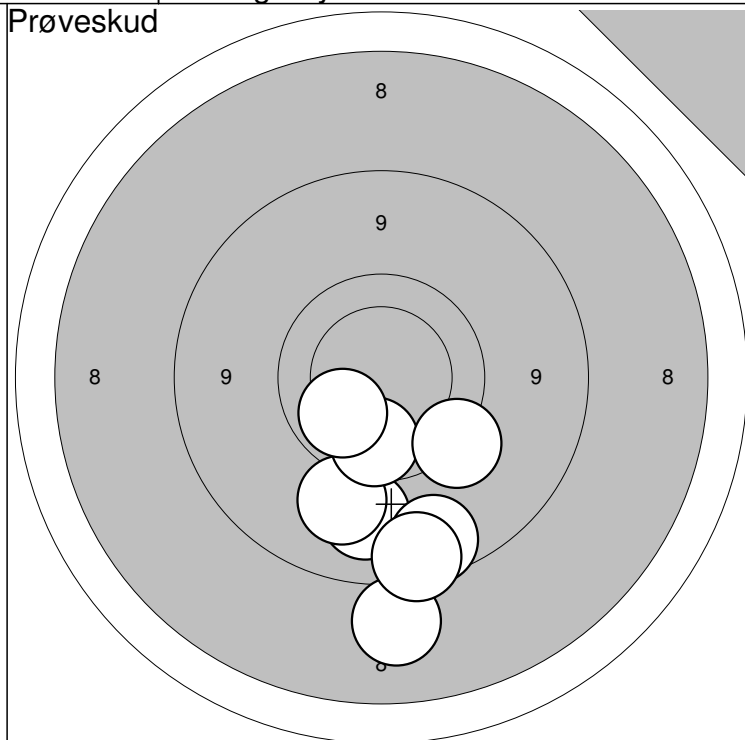

1: 9,8 →



6: 9,9 ↓



Serie: 94,0

2: 10,3 ←



7: 9,3 ←



3: 10,3 ↓



8: 9,3 ↓



4: 10,4 ↓



9: 9,8 ↓



5: 10,1 ↓



10: 9,4 ↓



Sum: 0,0

11: 9,2 ↓



16: 9,9 ↓



Serie: 70,0

12: 8,9 ↓



17: 10,1 ←



13: 8,4 ↓



18: 9,5 ↓



14: 8,8 ↓



Sum: 0,0

15: 9,3 ↓



Gældende

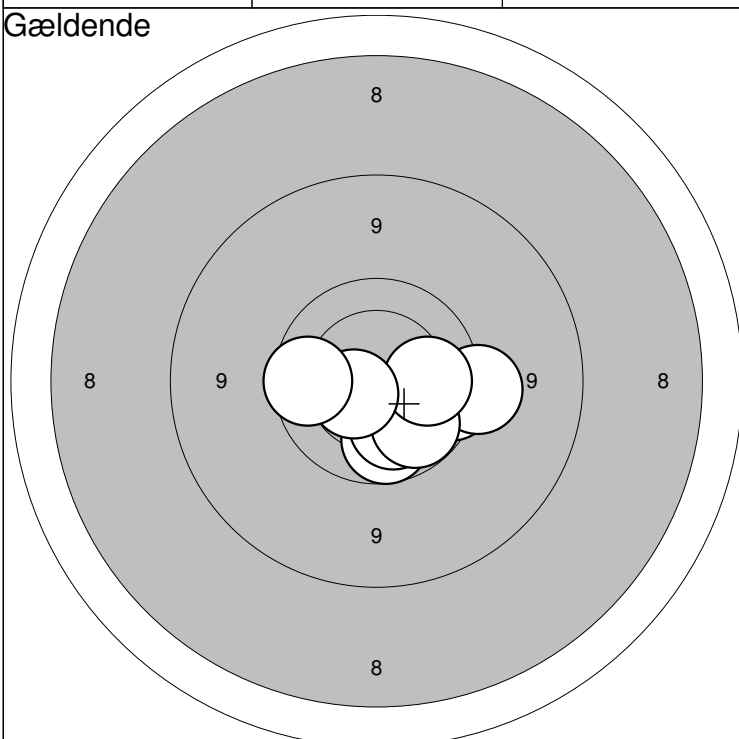

Gældende

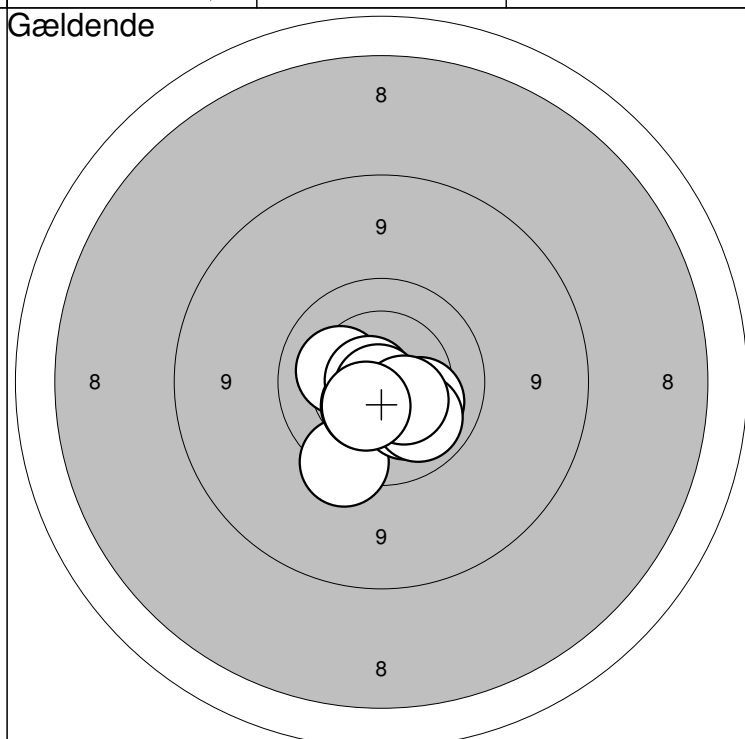

1: 10,0 →



6: 10,1 ↓



Serie: 96,0

2: 9,8 →



7: 10,0 ↓



3: 9,9 ↓



8: 10,1 →



4: 10,3 ↓



9: 10,5\* ←



5: 9,5 →



10: 9,9 ←



Sum: 96,0

11: 10,2 ←



16: 10,1 ↓



Serie: 99,0

12: 9,7 ↓



17: 10,7\* ←



13: 10,2 →



18: 10,8\* ↓



14: 10,5 ↓



19: 10,4 →



15: 10,2 ↓



20: 10,5 ↓



Sum: 195,0

Jyllandsstævne 2011

Hold  
**52**Bane  
**7****Ruth Thorius**

Vilsted Skf.

ÅK3

Jyllandsstævne 2011 - riffel

Aalborg Skyttekreds

Prøveskud

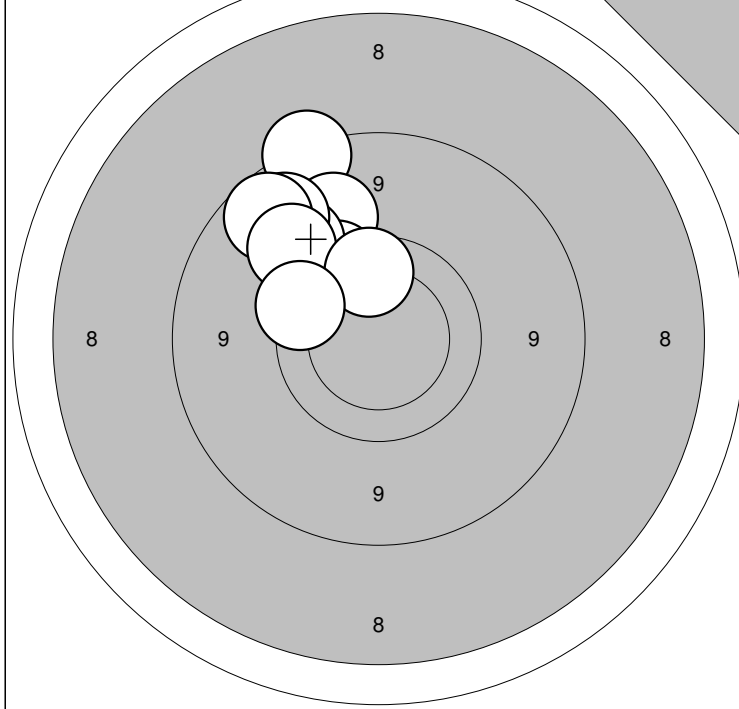

Prøveskud

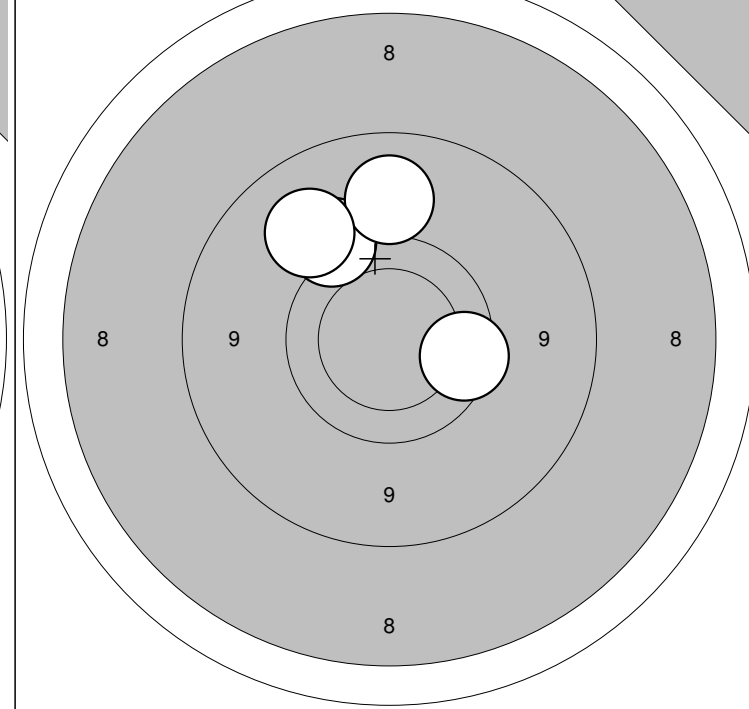

1: 8,7 ↗	6: 9,0 ↗
2: 9,4 ↗	7: 8,9 ↗
3: 9,3 ↗	8: 9,3 ↗
4: 9,7 ↗	9: 9,9 ↗
5: 9,3 ↗	10: 9,7 ↖

Serie:	88,0
Sum:	0,0

11: 9,4 ↗	12: 9,2 ↑
13: 9,8 →	14: 9,2 ↗

Serie:	36,0
Sum:	0,0

Gældende

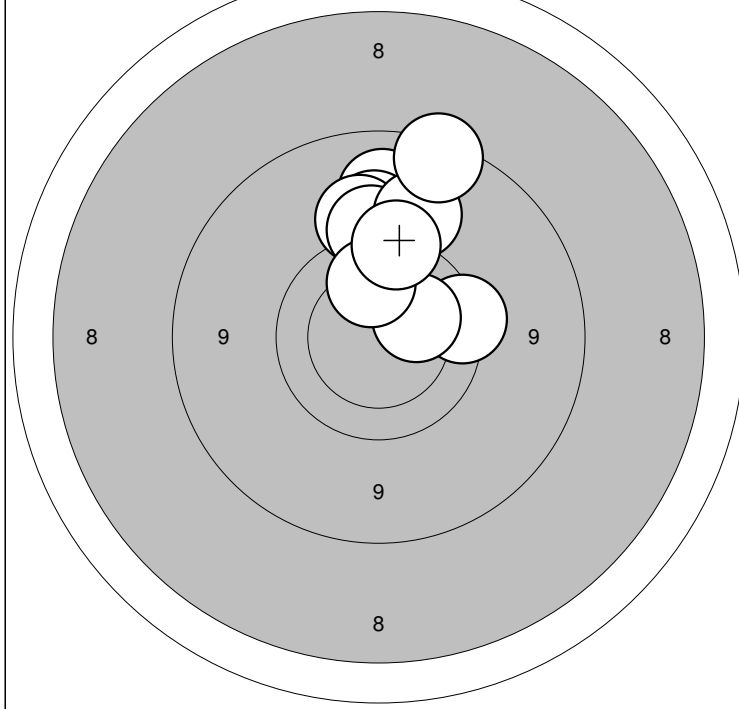

Gældende

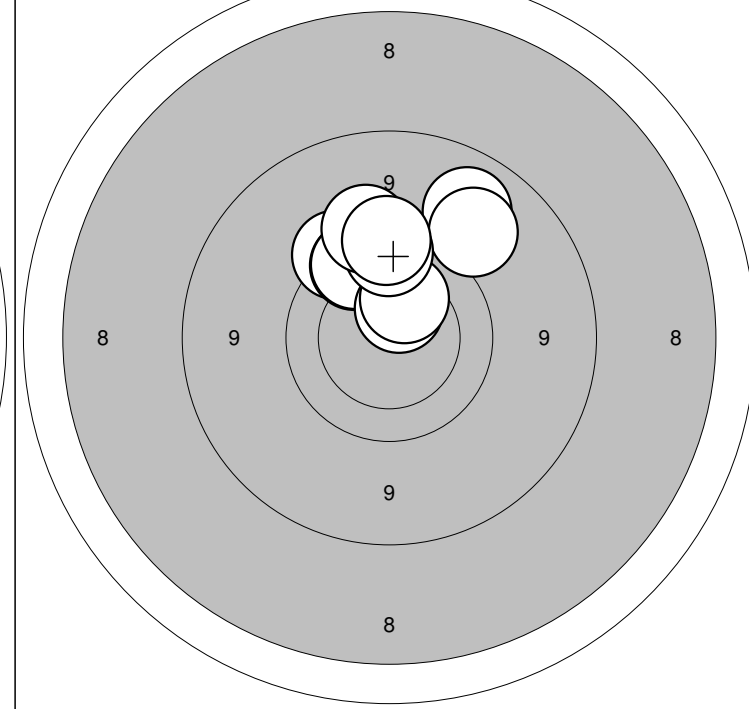

1: 9,1 ↑	6: 9,3 ↑
2: 9,3 ↑	7: 10,2 →
3: 9,4 ↑	8: 10,0 ↑
4: 9,7 →	9: 9,6 ↑
5: 9,5 ↑	10: 8,8 ↑

Serie:	91,0
Sum:	91,0

11: 9,6 ↗	12: 9,1 ↗	13: 9,2 ↗	14: 9,7 ↗	15: 9,7 ↗
16: 10,4 ↑	17: 10,2 ↑	18: 9,7 ↑	19: 9,4 ↑	20: 9,6 ↑

Serie:	92,0
Sum:	183,0

Jyllandsstævne 2011



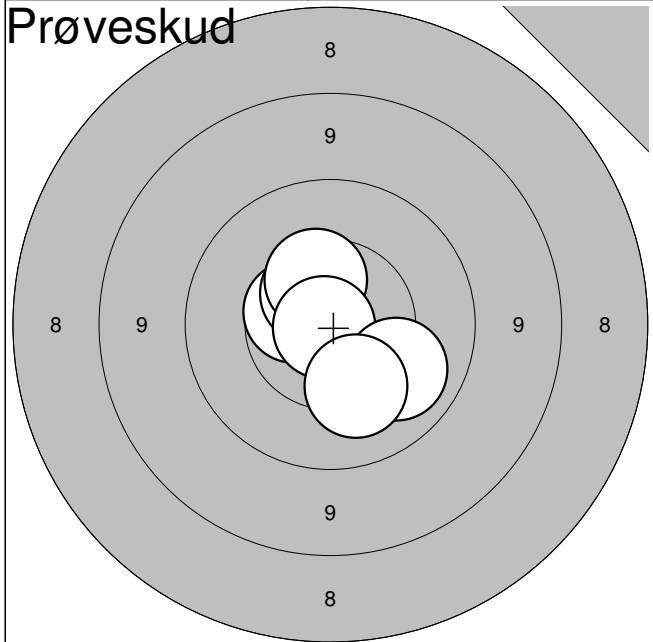

1:	10,6	↖
2:	10,6	↗
3:	10,5	↗
4:	10,9*	↖
5:	10,1	↘
6:	10,2	↘

<b>Serie:</b>	<b>60,0</b>
<b>Sum:</b>	<b>0,0</b>

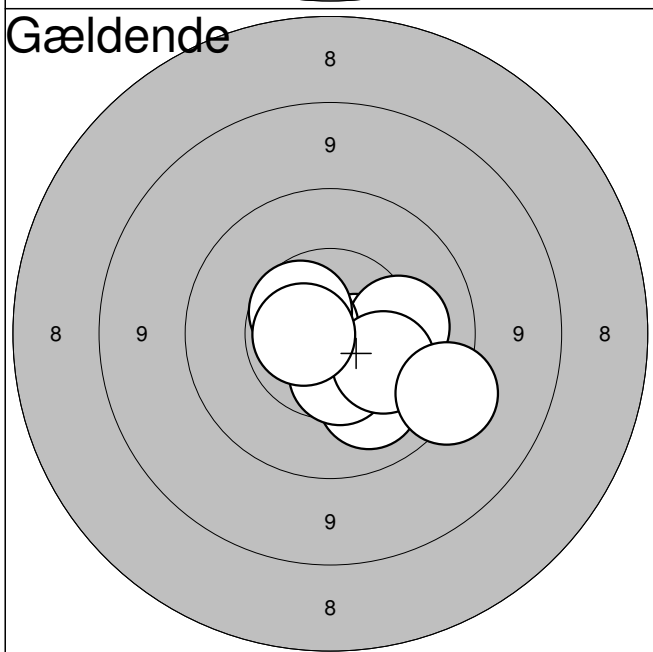

1:	10,7*	↘
2:	10,6	↘
3:	10,2	→
4:	10,2	↘
5:	10,7*	↖
6:	10,5	↘
7:	10,3	↘
8:	9,5	↘
9:	10,6	↗
10:	10,7*	←

<b>Serie:</b>	<b>99,0</b>
<b>Sum:</b>	<b>99,0</b>

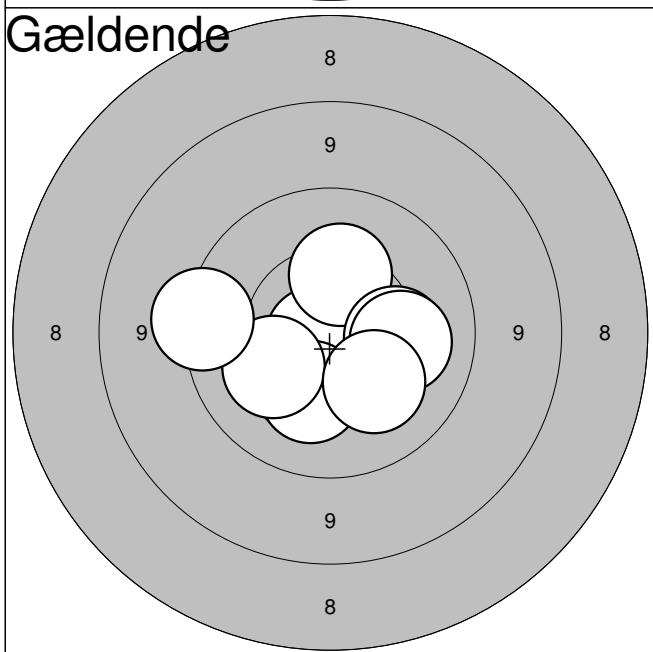

11:	10,4	↘
12:	10,4	↘
13:	10,8*	↖
14:	10,3	↑
15:	10,3	→
16:	10,2	→
17:	10,3	↘
18:	10,3	↖
19:	10,2	↘
20:	9,6	←

<b>Serie:</b>	<b>99,0</b>
<b>Sum:</b>	<b>198,0</b>

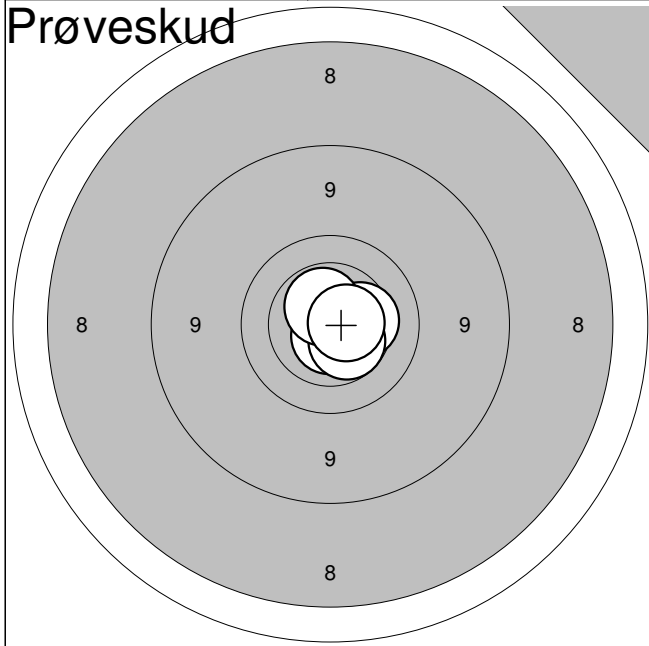

1:	10,4	→
2:	10,7*	↓
3:	10,5	↓
4:	10,6*	↑
5:	10,6*	→

<b>Serie:</b>	<b>50,0</b>
<b>Sum:</b>	<b>0,0</b>

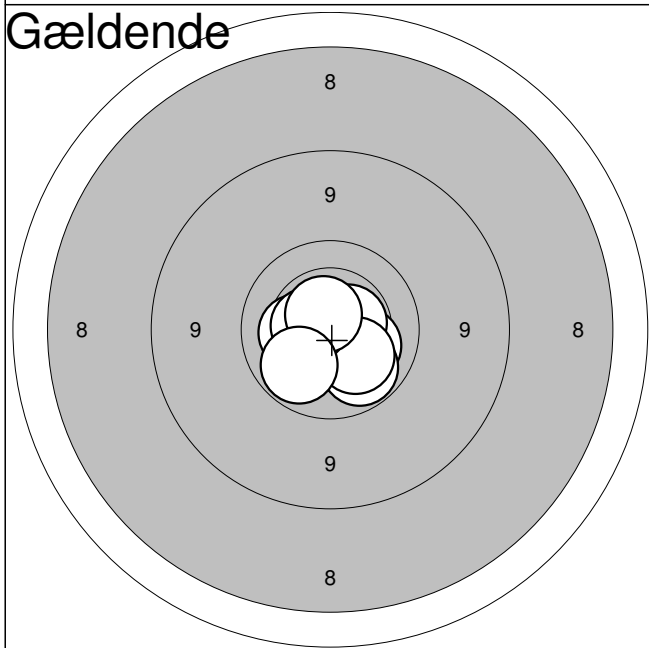

1:	10,2	↘
2:	10,7*	←
3:	10,0	↓
4:	10,3	←
5:	10,4	↓
6:	10,6*	→
7:	10,2	↓
8:	10,5*	←
9:	10,6*	↑
10:	10,0	↘

<b>Serie:</b>	<b>100,0</b>
<b>Sum:</b>	<b>100,0</b>

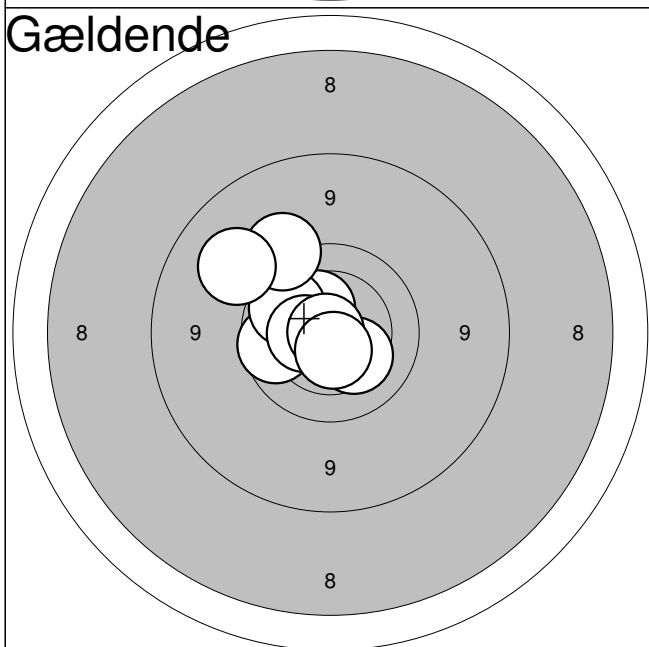

11:	10,5*	←
12:	10,3	↘
13:	9,9	←
14:	10,4	↑
15:	10,0	↑
16:	9,5	↑
17:	10,5	←
18:	10,9*	←
19:	10,6*	↘
20:	9,2	↑

<b>Serie:</b>	<b>97,0</b>
<b>Sum:</b>	<b>197,0</b>

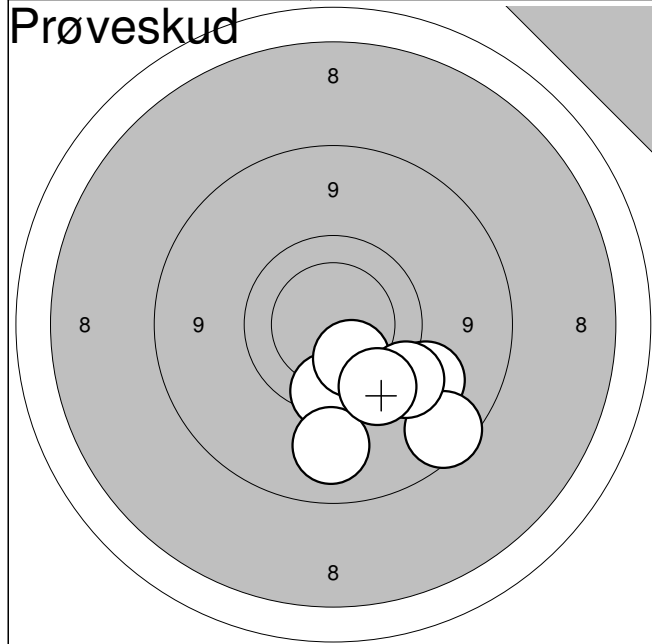

1:	9,3	↘
2:	9,8	↓
3:	8,9	↘
4:	9,2	↓
5:	10,2	↘
6:	9,5	↘
7:	9,7	↘

<b>Serie:</b>	<b>63,0</b>
<b>Sum:</b>	<b>0,0</b>

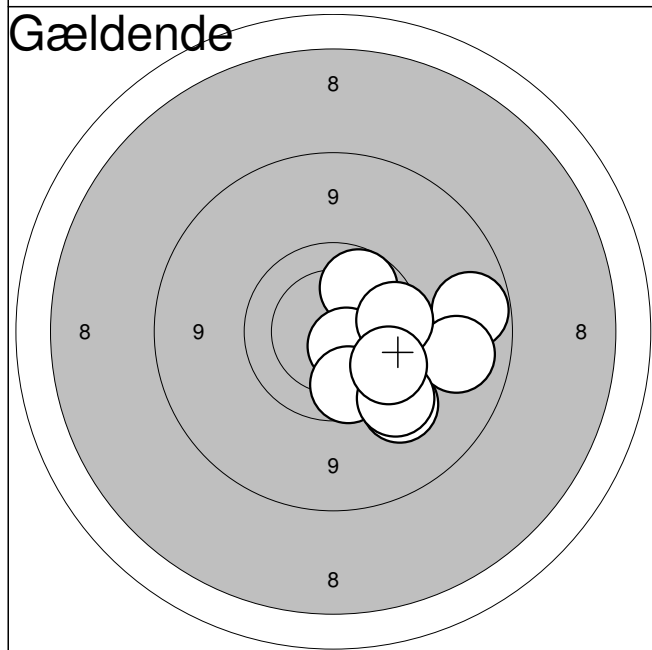

1:	9,6	→
2:	10,0	↗
3:	10,6*	↘
4:	9,4	↘
5:	9,0	→
6:	9,9	↘
7:	9,1	→
8:	9,5	↘
9:	9,8	→
10:	9,8	↘

<b>Serie:</b>	<b>92,0</b>
<b>Sum:</b>	<b>92,0</b>

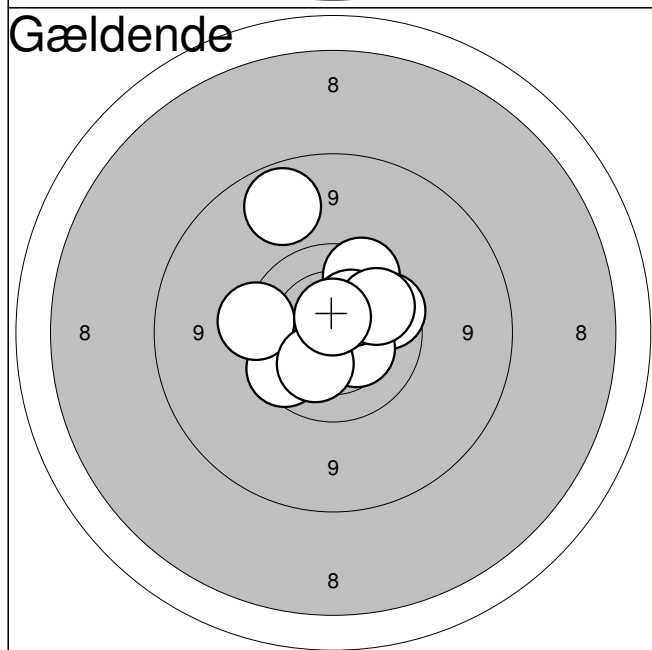

11:	9,8	↗
12:	9,9	↘
13:	9,9	→
14:	10,4	↘
15:	10,4	↗
16:	9,0	↗
17:	9,7	←
18:	10,0	→
19:	10,2	↘
20:	10,6*	↑

<b>Serie:</b>	<b>95,0</b>
<b>Sum:</b>	<b>187,0</b>

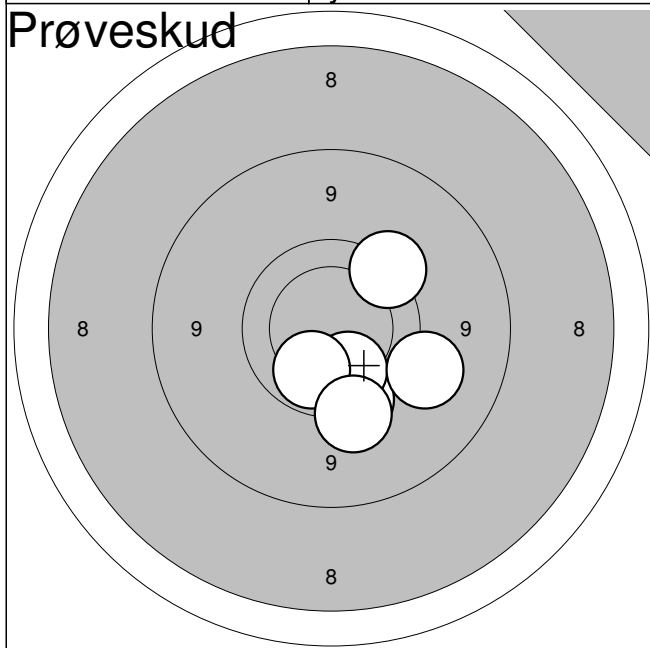

1:	9,7	↓
2:	10,1	↓
3:	9,6	↗
4:	9,4	→
5:	10,1	↓
6:	9,5	↓

**Serie: 56,0**

**Sum: 0,0**

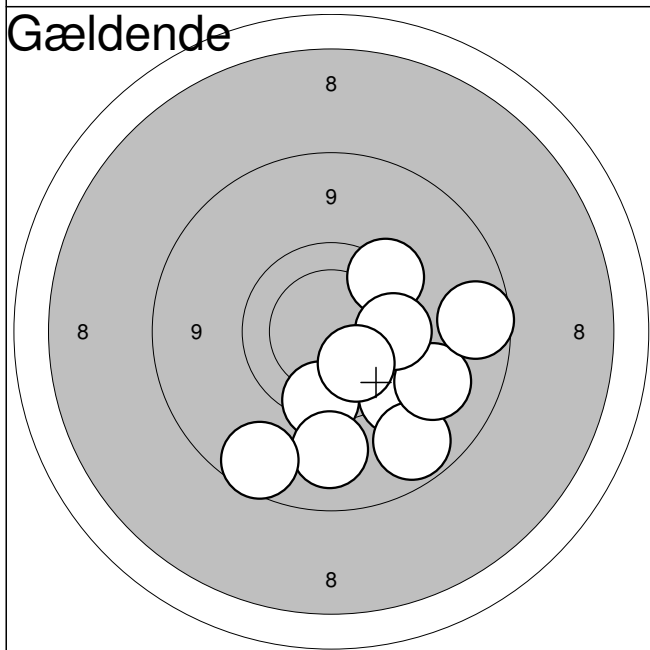

1:	9,7	↓
2:	9,5	↓
3:	9,0	↓
4:	9,3	→
5:	9,7	↗
6:	9,2	↓
7:	8,9	↓
8:	8,9	→
9:	9,8	→
10:	10,1	↓

**Serie: 89,0**

**Sum: 89,0**

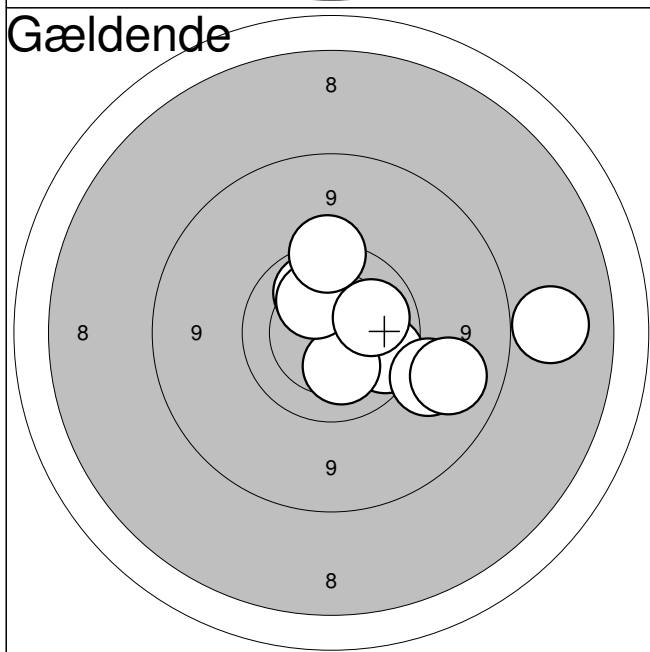

11:	8,4	→
12:	10,3	↓
13:	9,9	↓
14:	9,3	↓
15:	10,1	↗
16:	10,3	↓
17:	10,2	↗
18:	9,1	↓
19:	10,1	→
20:	9,6	↑

**Serie: 94,0**

**Sum: 183,0**

Aalborg Skyttekreds

ÅK3

Jyllandsstævne 2011 - riffel

Aalborg Skyttekreds

**Prøveskud**

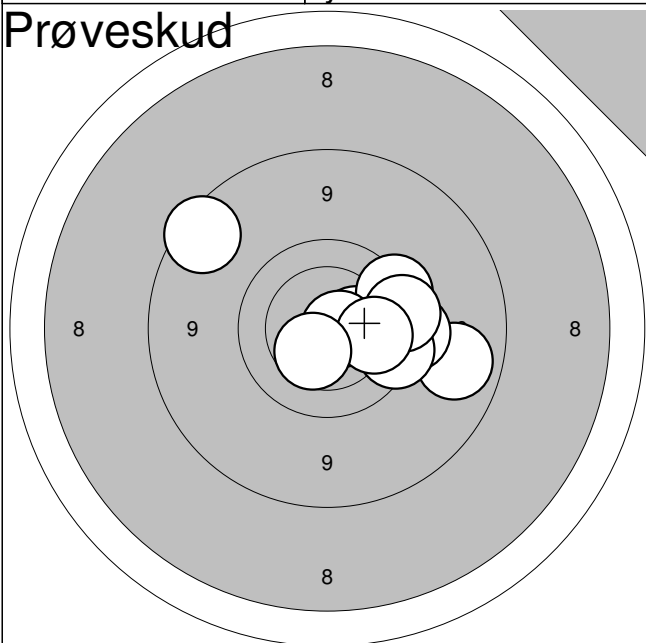

1:	8,8	↗
2:	9,1	→
3:	9,6	→
4:	9,7	→
5:	10,4	→
6:	9,7	↗
7:	10,7*	→
8:	9,7	→
9:	10,0	→
10:	10,4	↘

**Serie: 93,0**

**Sum: 0,0**

**Gældende**

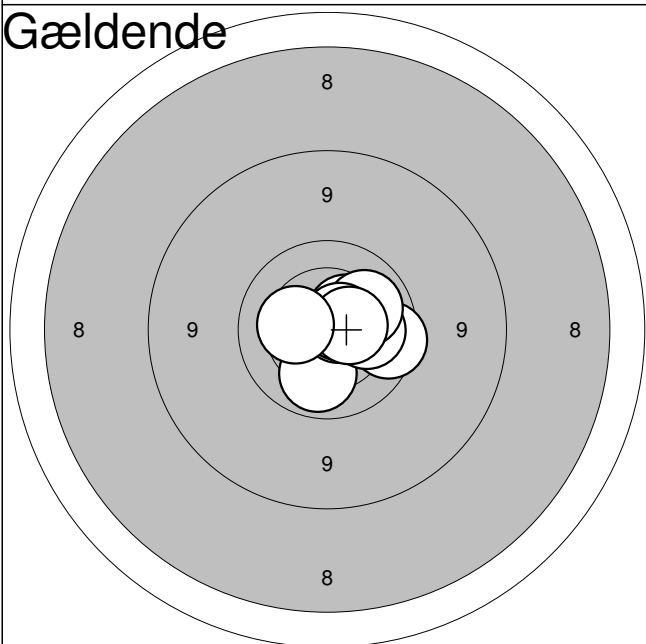

1:	10,5	↗
2:	10,1	↘
3:	10,7*	↗
4:	9,8	→
5:	10,4	→
6:	10,2	→
7:	10,1	↗
8:	10,7*	↗
9:	10,5*	→
10:	10,3	←

**Serie: 99,0**

**Sum: 99,0**

**Gældende**

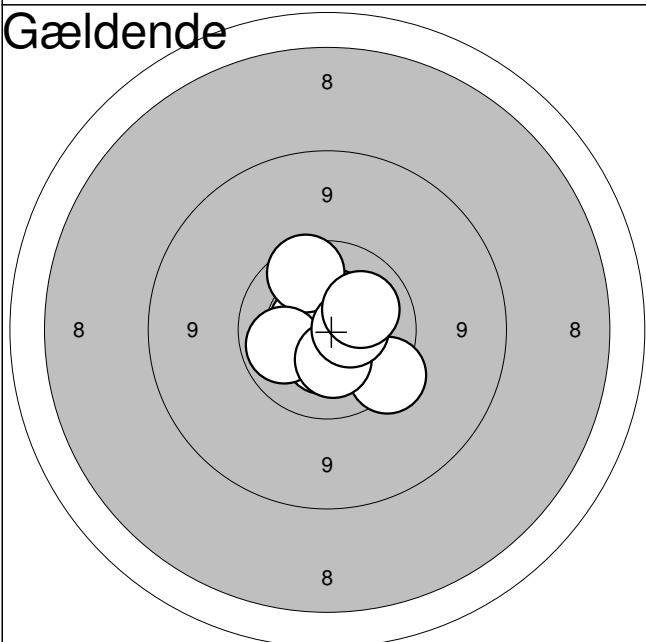

11:	10,5*	↑
12:	10,4	↘
13:	9,7	↘
14:	10,5*	↖
15:	10,7*	↘
16:	9,9	↗
17:	10,1	←
18:	10,4	↘
19:	10,5*	→
20:	10,2	↗

**Serie: 98,0**

**Sum: 197,0**

Hold

53

Bane

2

Claus Nielsen

Aalborg Skyttekreds

2

Jyllandsstævne 2011 - riffel

Aalborg Skyttekreds

Prøveskud

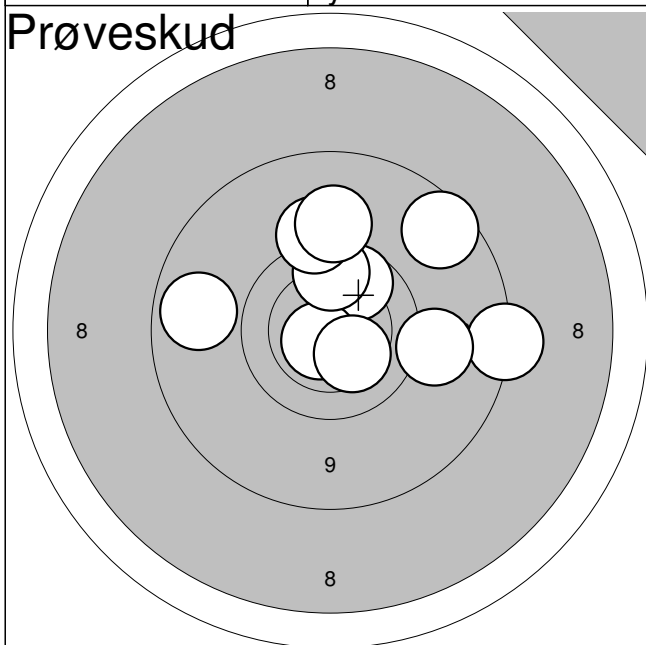

1:	8,9	↗
2:	9,9	↗
3:	10,7*	↘
4:	9,9	↑
5:	9,0	←
6:	8,7	→
7:	9,3	→
8:	9,5	↑
9:	9,3	↑
10:	10,3	↘

Serie: 90,0

Sum: 0,0

Gældende

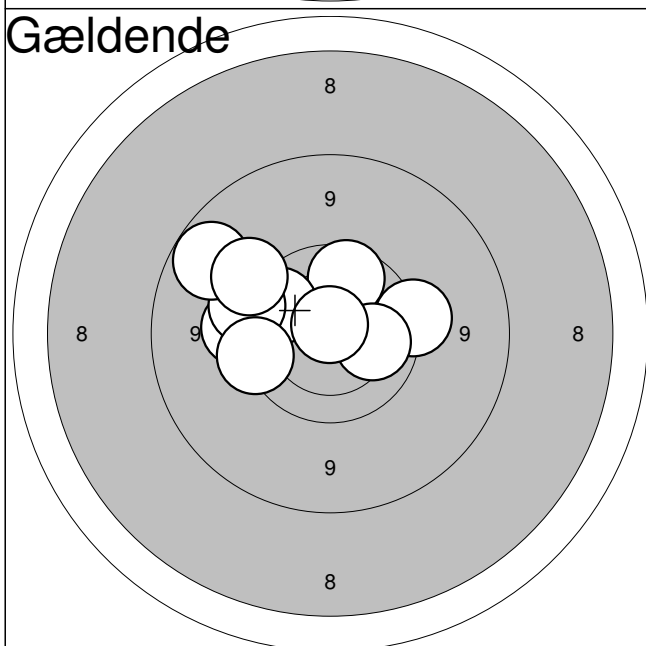

1:	9,9	↑
2:	9,9	↖
3:	9,5	←
4:	9,6	→
5:	10,1	→
6:	9,5	↖
7:	10,8*	↑
8:	9,0	↖
9:	9,4	↗
10:	9,7	←

Serie: 92,0

Sum: 92,0

Gældende

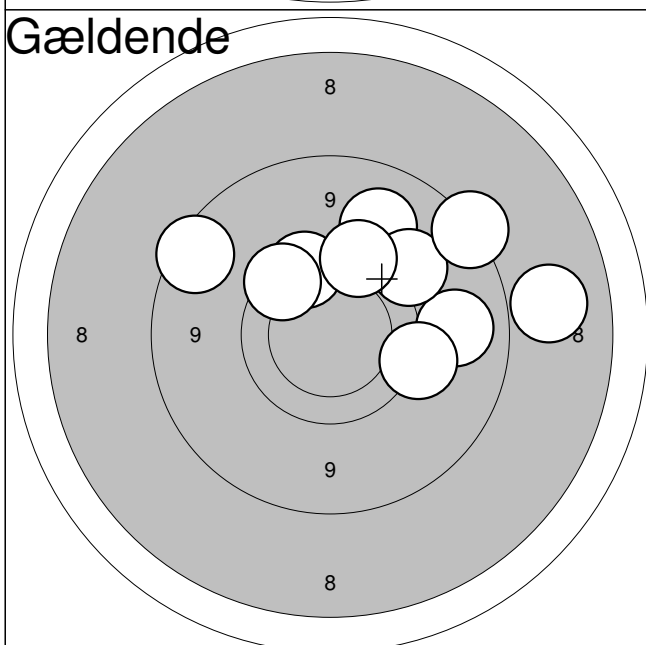

11:	9,2	↑
12:	9,7	↑
13:	9,1	→
14:	8,4	→
15:	8,8	↗
16:	9,4	↗
17:	9,5	→
18:	9,7	↗
19:	8,7	↗
20:	9,6	↑

Serie: 87,0

Sum: 179,0

Jyllandsstævne 2011

Hold

53

Bane

3

Jarl Linde

Vilsted Skf.

3

Jyllandsstævne 2011 - riffel

Aalborg Skyttekreds

## Prøveskud

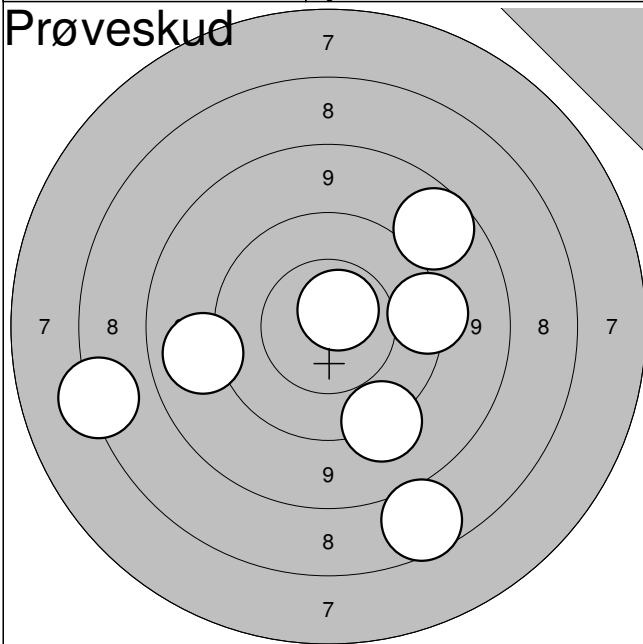

1: 9,4



2: 10,7\*



3: 7,5



4: 9,2



5: 8,9



6: 7,9



7: 9,6



Serie: 59,0

Sum: 0,0

## Gældende

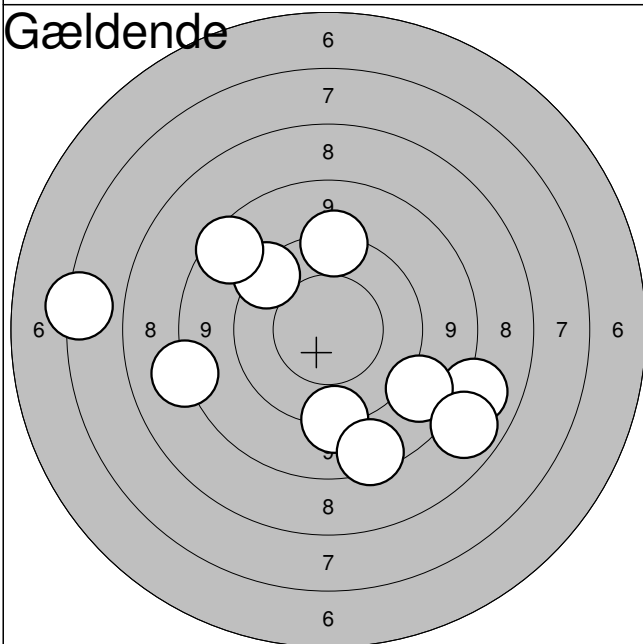

1: 9,6



2: 8,2



3: 9,4



4: 8,7



5: 9,1



6: 8,4



7: 8,1



8: 6,6



9: 9,5



10: 8,8



Serie: 82,0

Sum: 82,0

## Gældende

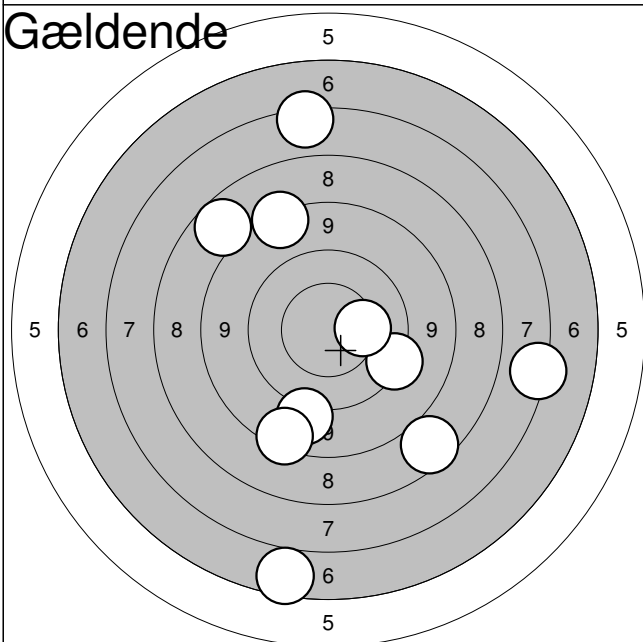

11: 9,5



12: 6,5



13: 10,3



14: 8,0



15: 8,5



16: 7,8



17: 5,8



18: 9,1



19: 6,6



20: 8,6



Serie: 76,0

Sum: 158,0

Jyllandsstævne 2011

Hold

53

Bane

4

Ruby Larsen

Vilsted Skf.

ÅK3

Jyllandsstævne 2011 - riffel

Aalborg Skyttekreds

Prøveskud

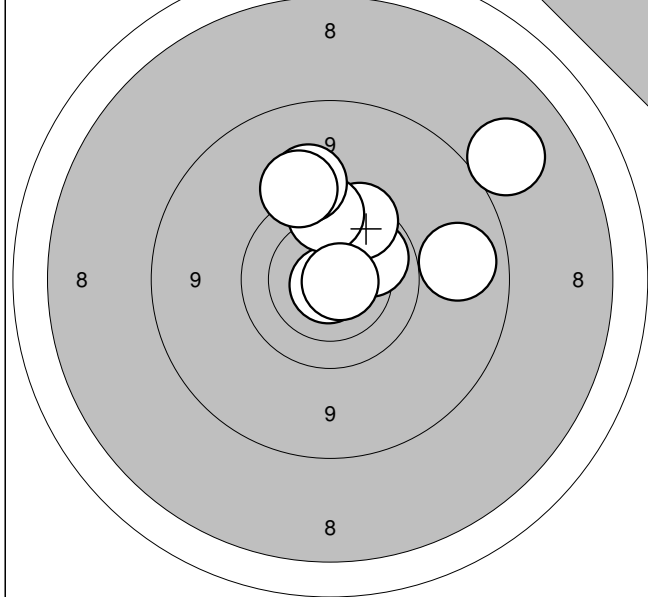

1:	8,4	↗
2:	9,1	→
3:	10,8*	↓
4:	10,1	↗
5:	9,8	↗
6:	9,8	↑
7:	9,4	↑
8:	9,5	↑
9:	10,7*	→

Serie: 83,0

Sum: 0,0

Gældende

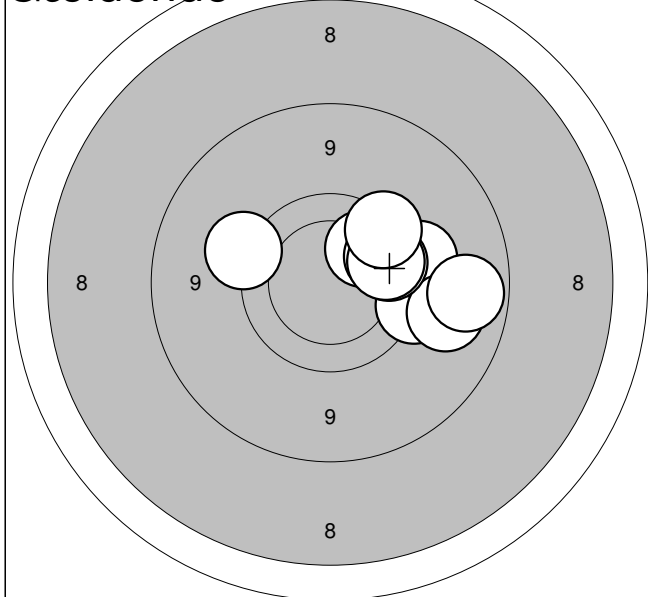

1:	9,5	→
2:	10,0	↗
3:	9,5	→
4:	9,2	→
5:	9,0	→
6:	9,8	↗
7:	9,9	↗
8:	9,9	→
9:	9,5	←
10:	9,7	↗

Serie: 91,0

Sum: 91,0

Gældende

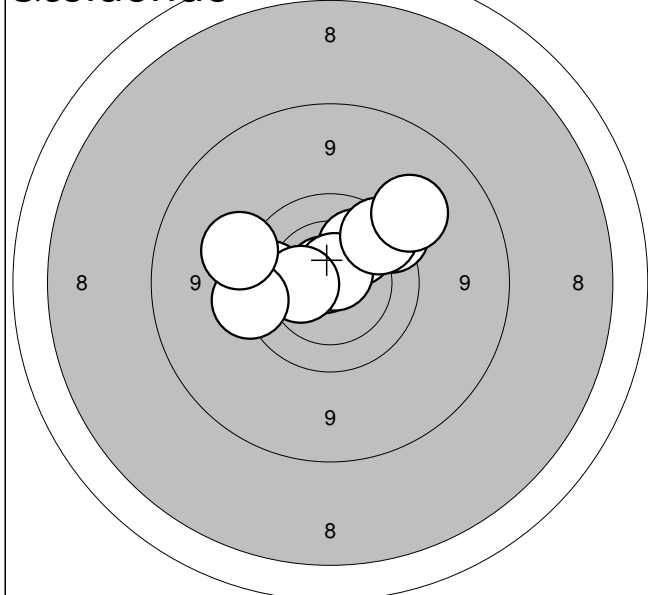

11:	10,1	↗
12:	10,8*	↖
13:	9,7	↗
14:	9,8	←
15:	10,7*	↑
16:	10,4	←
17:	9,6	←
18:	9,8	↗
19:	9,3	↗
20:	9,5	←

Serie: 94,0

Sum: 185,0

Jyllandsstævne 2011



Hold

53

Bane

5

## Asbjørn Risgård Nielsen

Vilsted Skf.

BK1

Jyllandsstævne 2011 - riffel

Aalborg Skyttekreds

## Prøveskud

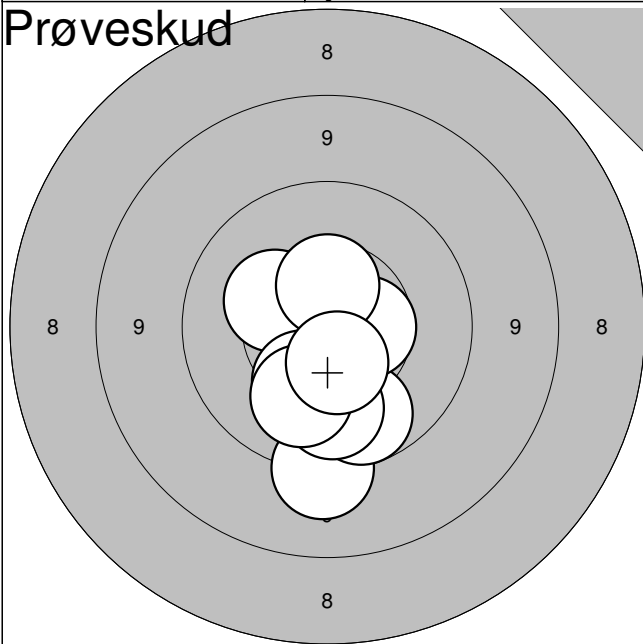

1:	10,3	↓
2:	9,4	↓
3:	10,0	↓
4:	10,1	↓
5:	10,5	→
6:	10,3	↖
7:	10,3	↓
8:	10,5	↑
9:	10,2	↓
10:	10,5	↓

Serie: 99,0

Sum: 0,0

## Gældende

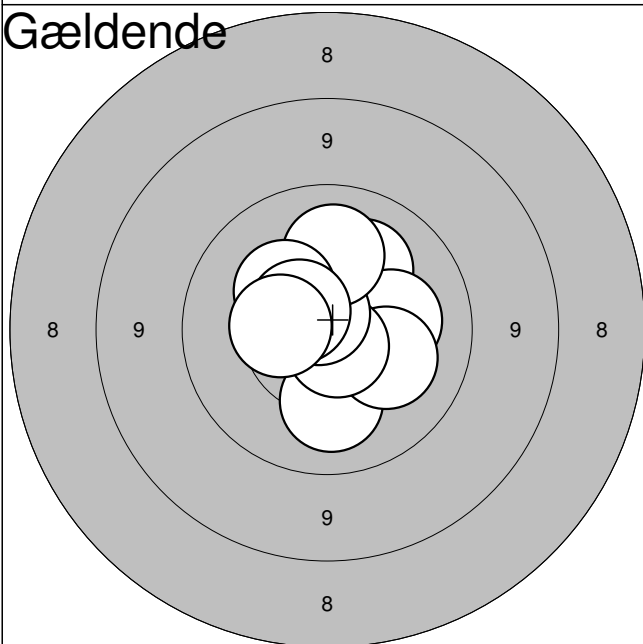

1:	10,2	↓
2:	10,2	↗
3:	10,3	→
4:	10,3	↘
5:	10,7*	↓
6:	10,8*	↗
7:	10,2	↑
8:	10,4	↗
9:	10,6*	↗
10:	10,5	←

Serie: 100,0

Sum: 100,0

## Gældende

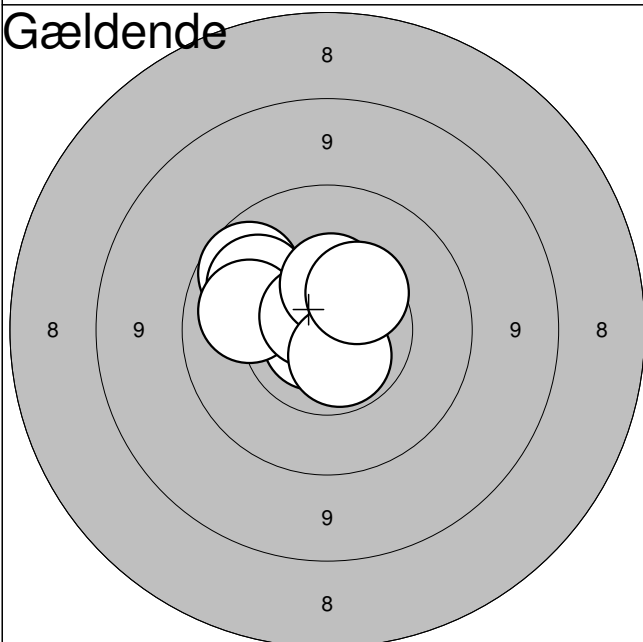

11:	9,9	↖
12:	10,7*	↑
13:	10,8*	↙
14:	10,1	↖
15:	10,1	←
16:	10,9*	↑
17:	10,7*	↗
18:	10,5	↑
19:	10,6*	↓
20:	10,4	↗

Serie: 99,0

Sum: 199,0

Jyllandsstævne 2011

Hold  
**53**Bane  
**6****Louise Jensen**

Løgstør Skyttelaug

UNG

Jyllandsstævne 2011 - riffel

Aalborg Skyttekreds

Prøveskud

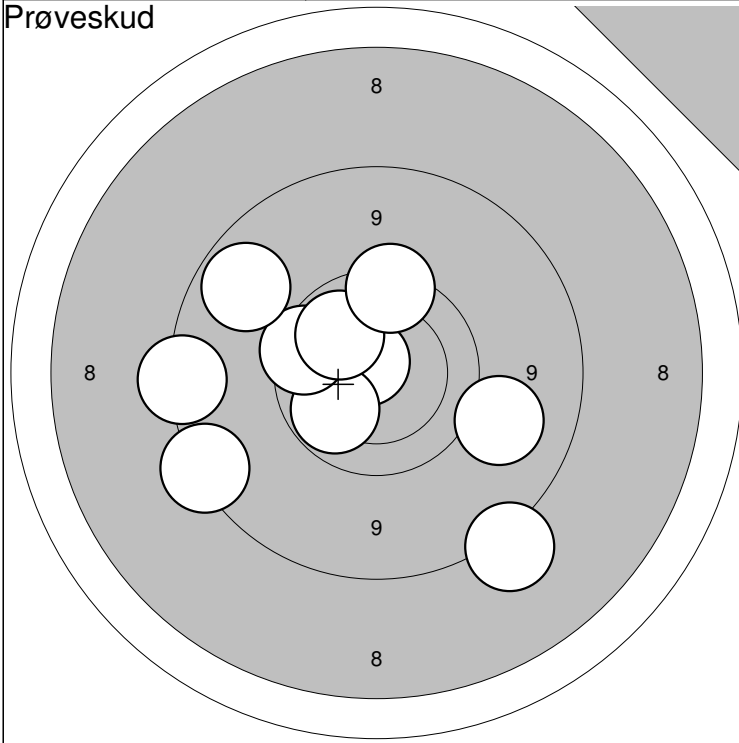

Prøveskud

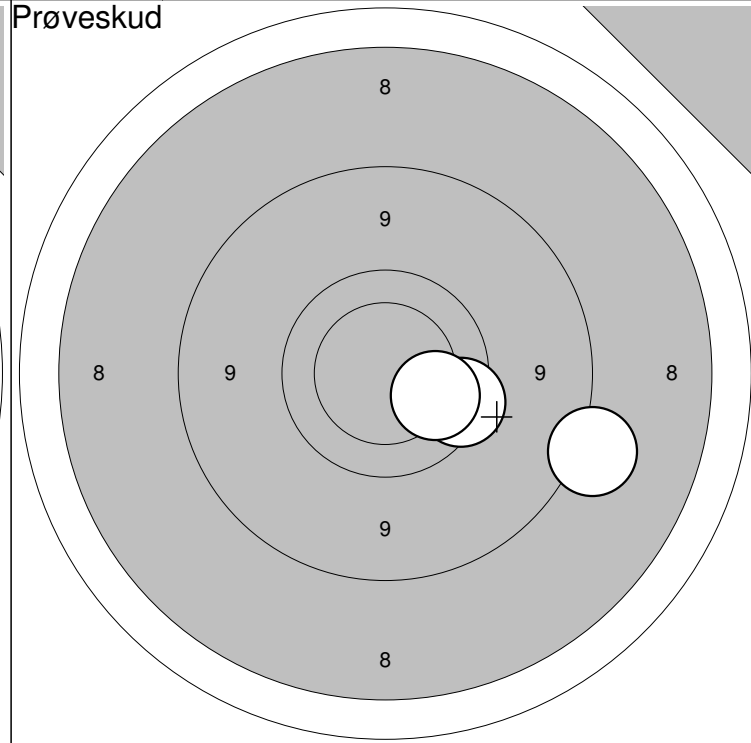

1: 8,8 ←

2:10,7\* ↗

3:10,0 ↘

4: 9,8 ←

5: 9,0 ↖

6:10,1 ↗

7: 8,6 ↘

8: 9,7 ↑

9: 8,7 ←

10: 9,2 →

Serie: 90,0

Sum: 0,0

11: 8,6 →

12: 9,7 →

13:10,0 →

Serie: 27,0

Sum: 0,0

Gældende

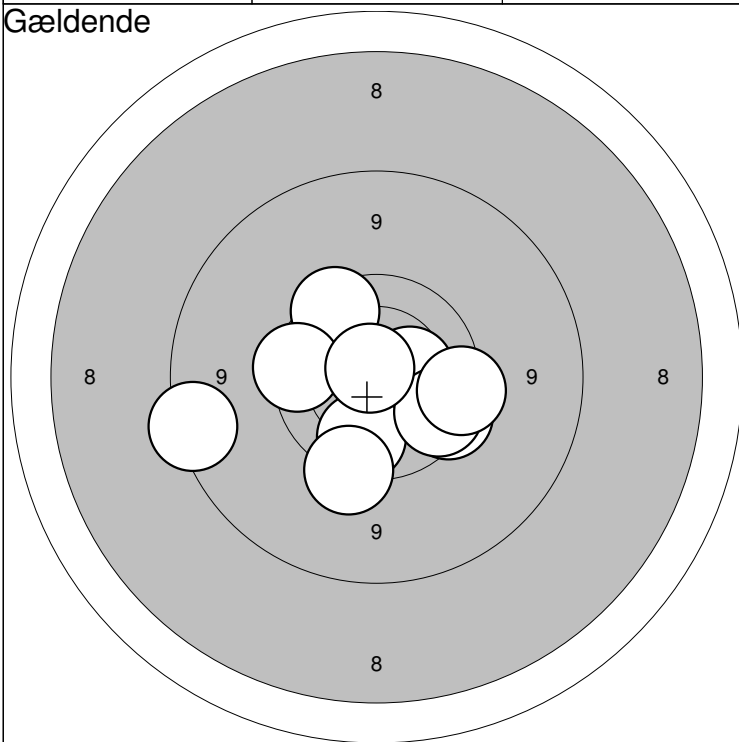

Gældende

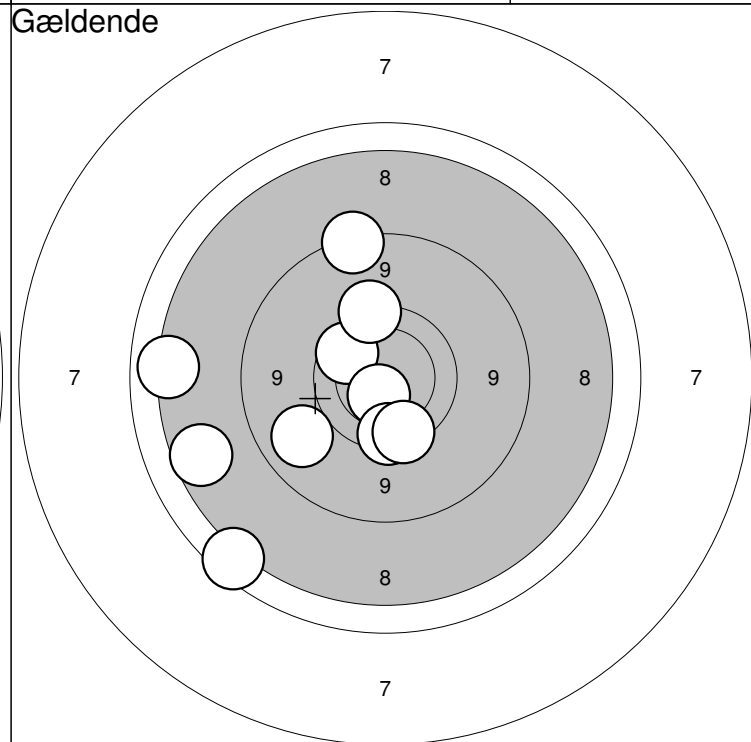

1: 9,7 →

2:10,4 →

3: 9,9 ↓

4: 9,8 →

5: 9,8 ↗

6: 8,8 ←

7: 9,8 ←

8:10,8\* ↗

9: 9,6 ↓

10: 9,7 →

Serie: 91,0

Sum: 91,0

11: 8,0 ←

12: 9,9 ↖

13:10,5\* ↓

14: 9,6 ↑

15: 8,2 ←

16: 8,7 ↑

17: 9,7 ↓

18: 7,8 ↘

19: 9,7 ↓

20: 9,1 ↖

Serie: 86,0

Sum: 177,0

Jyllandsstævne 2011

Hold  
**53**Bane  
**7****Lasse E. Nielsen**

Aalborg Skyttekreds

J2

Jyllandsstævne 2011 - riffel

Aalborg Skyttekreds

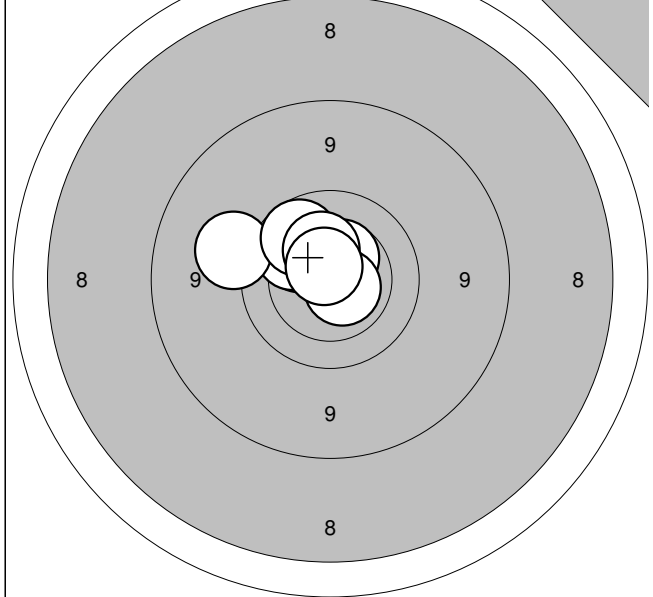
**Prøveskud**

1:	10,2	↗
2:	10,1	↗
3:	9,4	↖
4:	9,9	↗
5:	10,5	↗
6:	10,4	↗
7:	10,7*	↘
8:	10,7*	↗

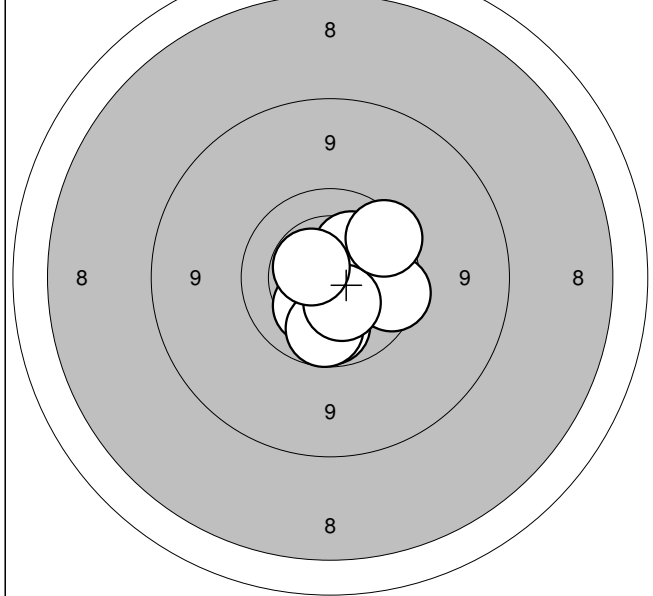
Serie: **78,0**Sum: **0,0****Gældende**

1:	10,0	↓
2:	10,6*	↗
3:	10,2	→
4:	10,3	↗
5:	10,3	↓
6:	9,8	→
7:	9,9	↓
8:	10,4	↓
9:	10,5*	↗
10:	9,8	↗

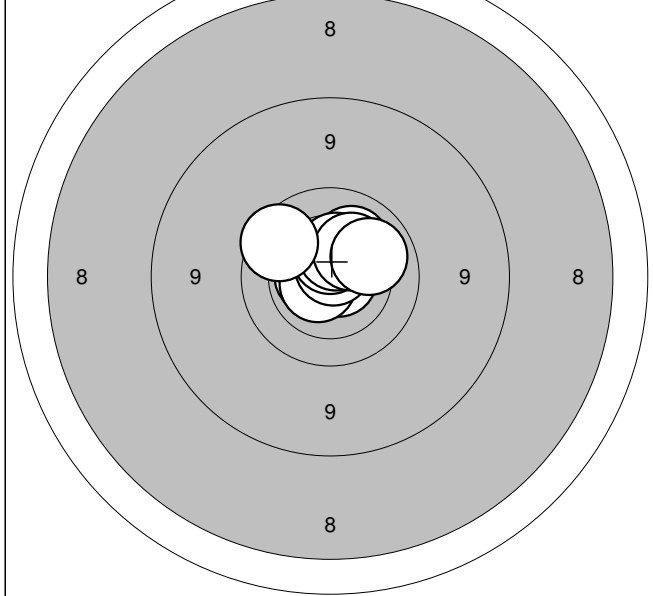
Serie: **97,0**Sum: **97,0****Gældende**

11:	10,6*	←
12:	10,8*	→
13:	10,7*	↖
14:	10,8*	↗
15:	10,5*	↑
16:	10,2	↗
17:	10,4	↑
18:	10,3	↗
19:	9,8	↖
20:	10,1	↗

Serie: **99,0**Sum: **196,0**

Jyllandsstævne 2011

Hold

53

Bane

8

Mathias Christensen

Vilsted Skf.

BK1

Jyllandsstævne 2011 - riffel

Aalborg Skyttekreds

Prøveskud

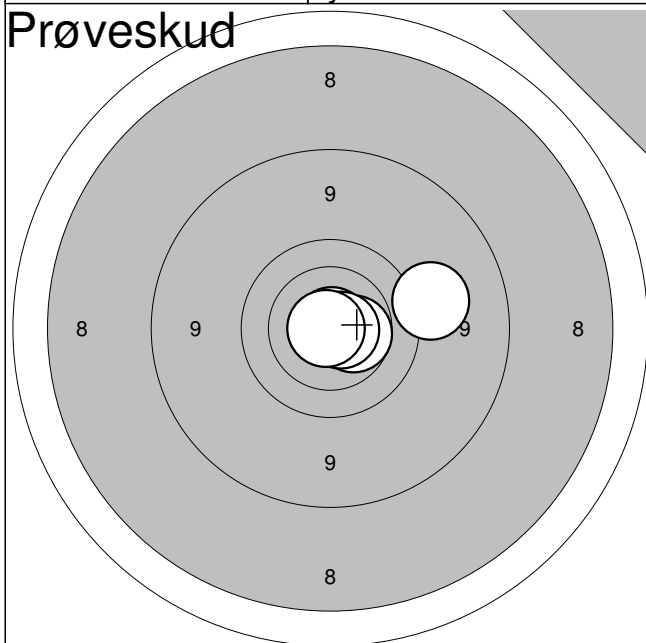

1:	9,4	→
2:	10,9*	↗
3:	10,5	→
4:	10,7*	→
5:	10,9*	←

Serie: 49,0

Sum: 0,0

Gældende

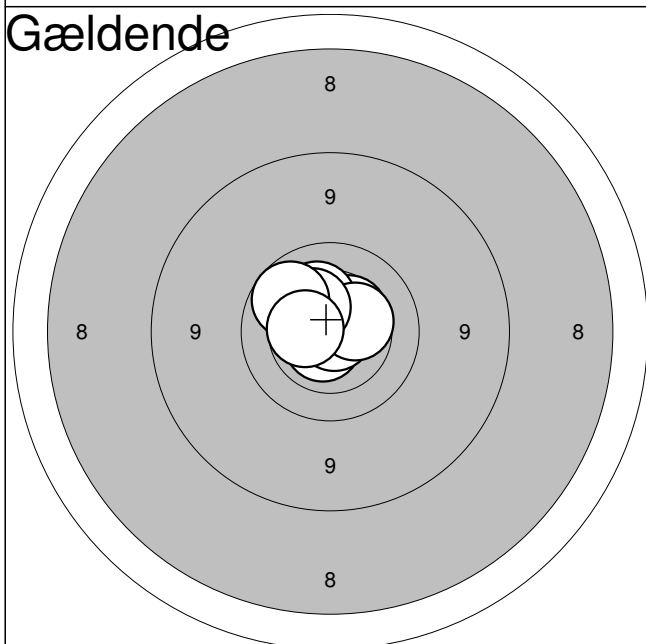

1:	10,7*	↖
2:	10,7*	↗
3:	10,4	↗
4:	10,7*	↘
5:	10,3	↖
6:	10,9*	→
7:	10,4	→
8:	10,4	↗
9:	10,0	↗
10:	10,5	←

Serie: 100,0

Sum: 100,0

Gældende

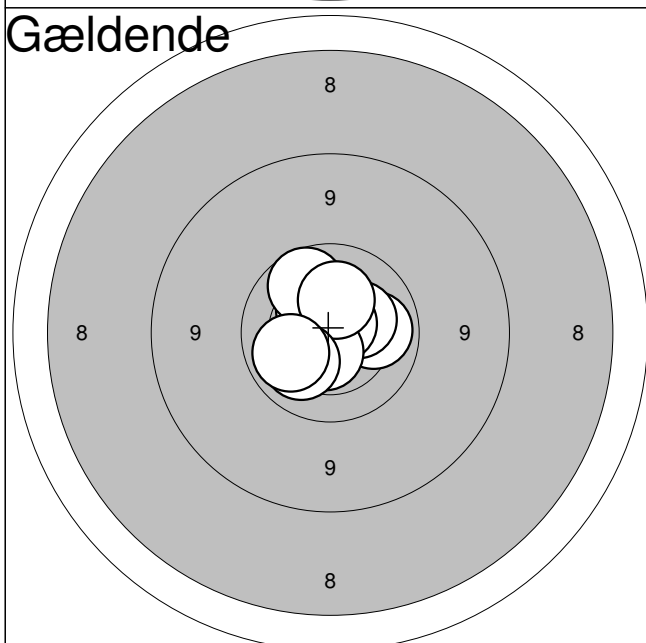

11:	10,1	→
12:	10,4	↗
13:	10,3	↗
14:	10,9*	↘
15:	10,7*	↗
16:	9,9	↖
17:	10,6*	↘
18:	10,3	↖
19:	10,2	↘
20:	10,1	←

Serie: 99,0

Sum: 199,0

Jyllandsstævne 2011

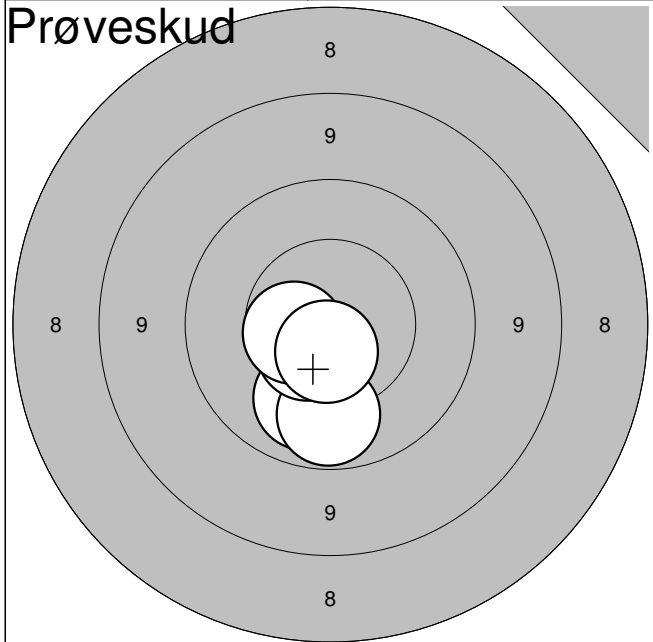

1:	10,1	↓
2:	10,0	↓
3:	10,6*	↙
4:	10,6	←
5:	10,7*	↓

Serie:	50,0
Sum:	0,0

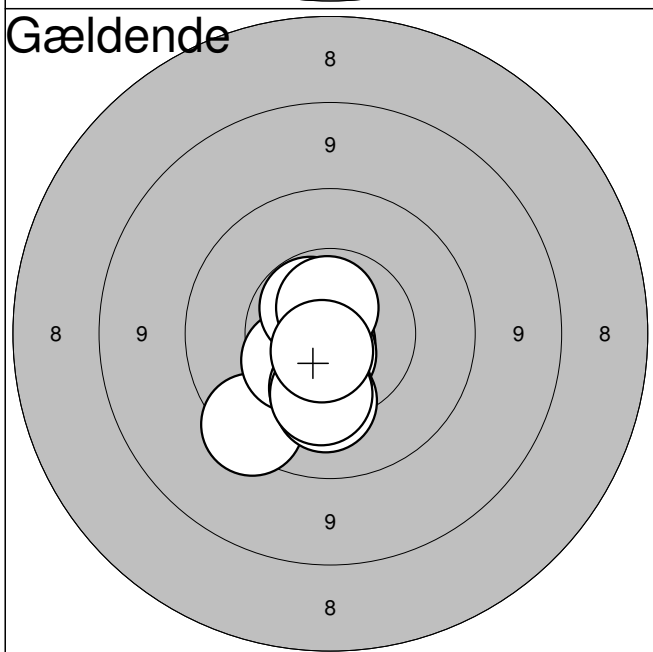

1:	10,8*	↙
2:	10,7*	↓
3:	9,7	↙
4:	10,2	↓
5:	10,5	↙
6:	10,4	↓
7:	10,3	↓
8:	10,6*	↗
9:	10,7*	↑
10:	10,7*	↓

Serie:	99,0
Sum:	99,0

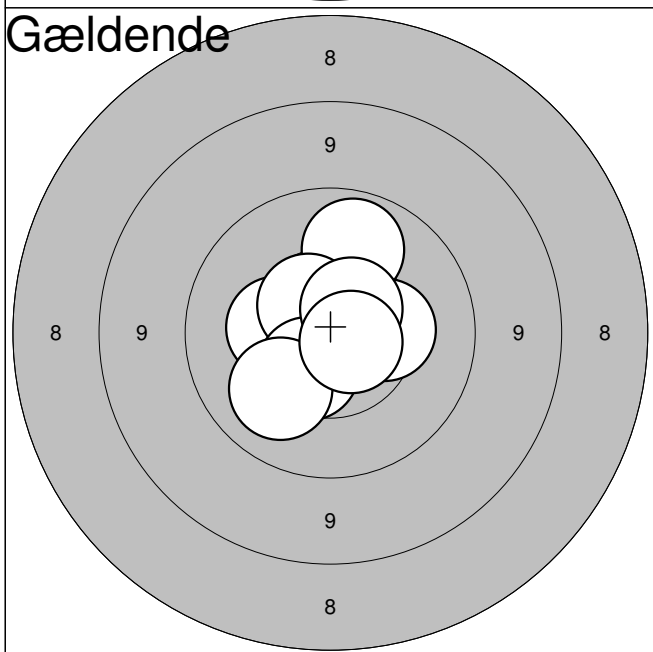

11:	10,7*	↑
12:	10,0	↑
13:	10,4	←
14:	10,6	↗
15:	10,7*	→
16:	10,5	↓
17:	10,4	→
18:	10,6*	↗
19:	10,2	↓
20:	10,7*	↘

Serie:	100,0
Sum:	199,0

Hold

53

Bane

10

Jeppe V. Kristensen

Aalborg Skyttekreds

1

Jyllandsstævne 2011 - riffel

Aalborg Skyttekreds

Prøveskud

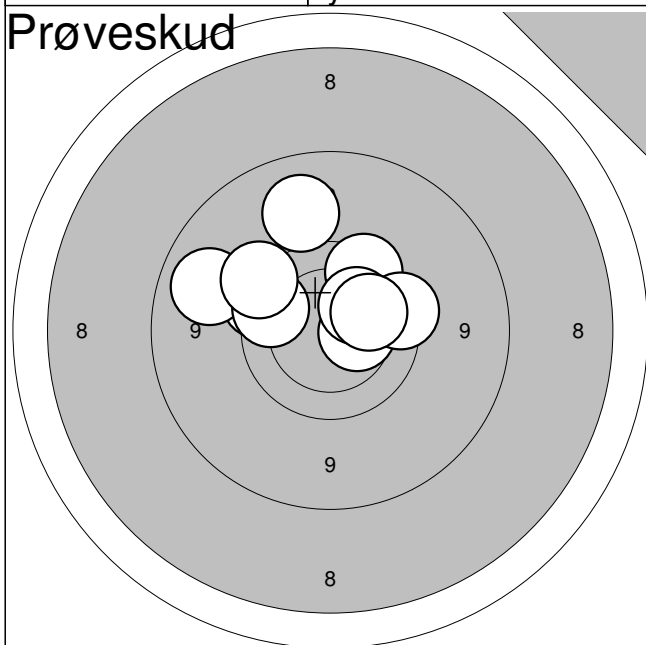

1:	9,2	↑
2:	9,7	↖
3:	9,1	↖
4:	9,8	↖
5:	10,4	→
6:	9,8	↗
7:	10,2	↗
8:	9,7	→
9:	9,6	↖
10:	10,1	→

Serie: 93,0

Sum: 0,0

Gældende

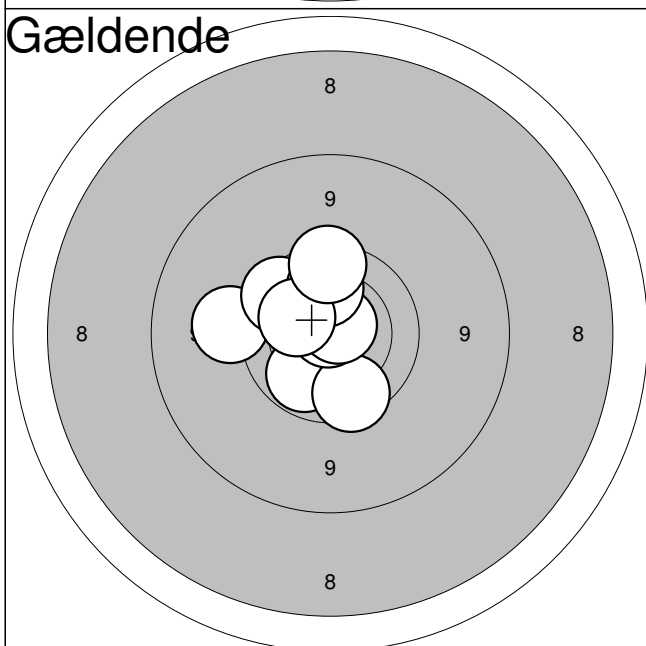

1:	10,0	↑
2:	10,0	↘
3:	9,8	↘
4:	10,9*	↗
5:	10,7*	↗
6:	9,4	←
7:	9,8	↗
8:	10,1	↑
9:	10,2	↖
10:	9,8	↑

Serie: 96,0

Sum: 96,0

Gældende

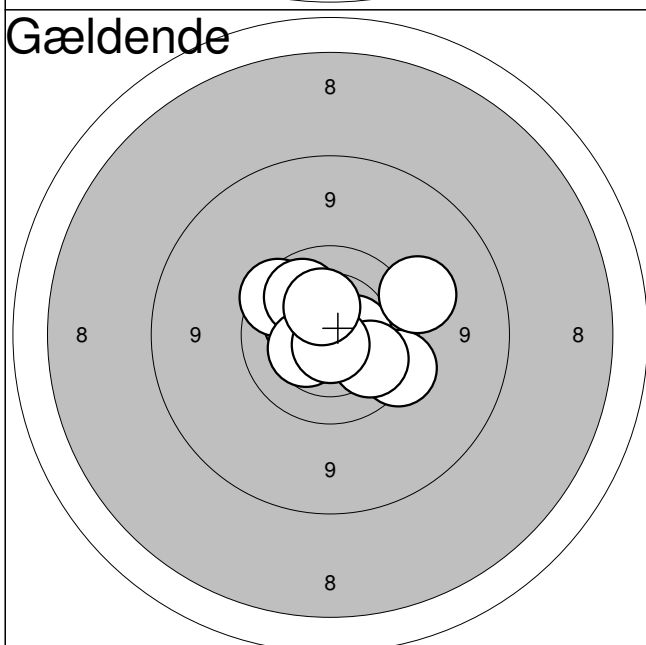

11:	10,3	↖
12:	9,8	↗
13:	10,0	↗
14:	10,5	→
15:	9,7	↘
16:	10,4	↖
17:	9,4	↗
18:	10,0	↘
19:	10,7*	↘
20:	10,4	↑

Serie: 97,0

Sum: 193,0

Jyllandsstævne 2011

Hold  
**53**Bane  
**11****Nikolai Wahlgreen**

Vilsted Skf.

ÅK2

Jyllandsstævne 2011 - riffel

Aalborg Skyttekreds

Prøveskud

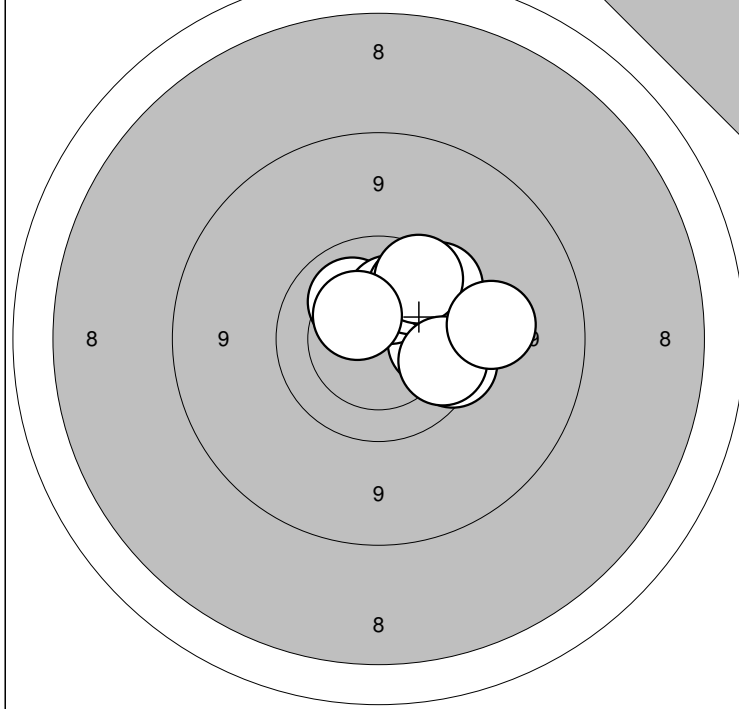

Prøveskud

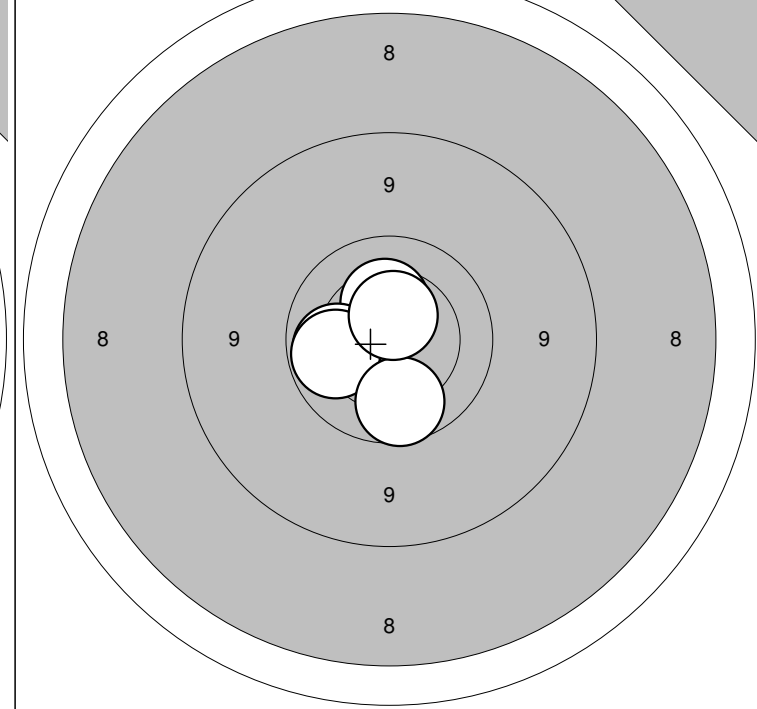

1:10,0 →  
2:10,2 ↗  
3:10,3 ↑  
4: 9,9 ↗  
5: 9,8 ↗

6: 9,8 →  
7: 9,8 ↗  
8: 9,9 →  
9: 9,4 →  
10:10,4 ↗

Serie: 94,0

Sum: 0,0

11:10,3 ↑  
12:10,1 ←  
13:10,0 ←  
14: 9,9 ↓  
15:10,5\* ↑

Serie: 49,0

Sum: 0,0

Gældende

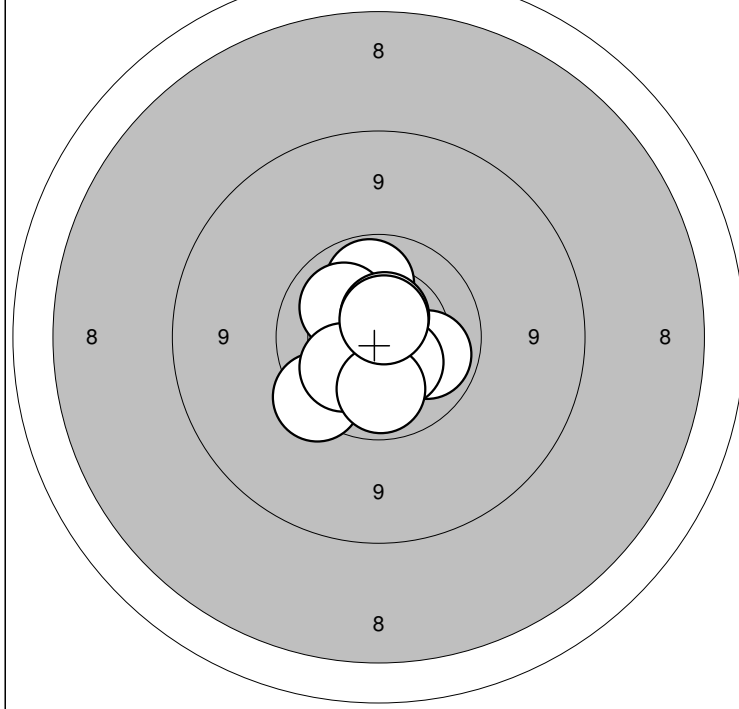

Gældende

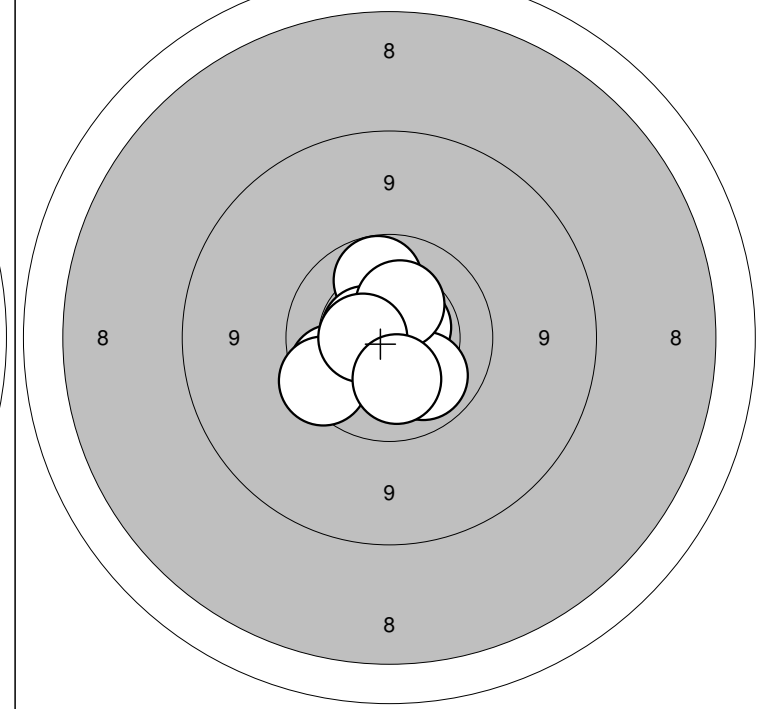

1:10,0 ↑  
2:10,6\* ↓  
3: 9,7 ↙  
4:10,1 →  
5:10,4 ↓

6:10,2 ↗  
7:10,2 ↙  
8:10,6\* ↑  
9:10,1 ↓  
10:10,6\* ↑

Serie: 99,0

Sum: 99,0

11:10,6\* ↘  
12: 9,9 ↙  
13:10,0 ↑  
14:10,5\* ↙  
15:10,6\* ↗

16: 9,8 ↙  
17:10,1 ↘  
18:10,4 ↑  
19:10,5\* ↙  
20:10,2 ↓

Serie: 98,0

Sum: 197,0

Jyllandsstævne 2011

Hold  
**53**

Bane  
**12**

# Jonas Engberg Hansen

Vilsted Skf.

BK3

Jyllandsstævne 2011 - riffel

Aalborg Skyttekreds

Prøveskud

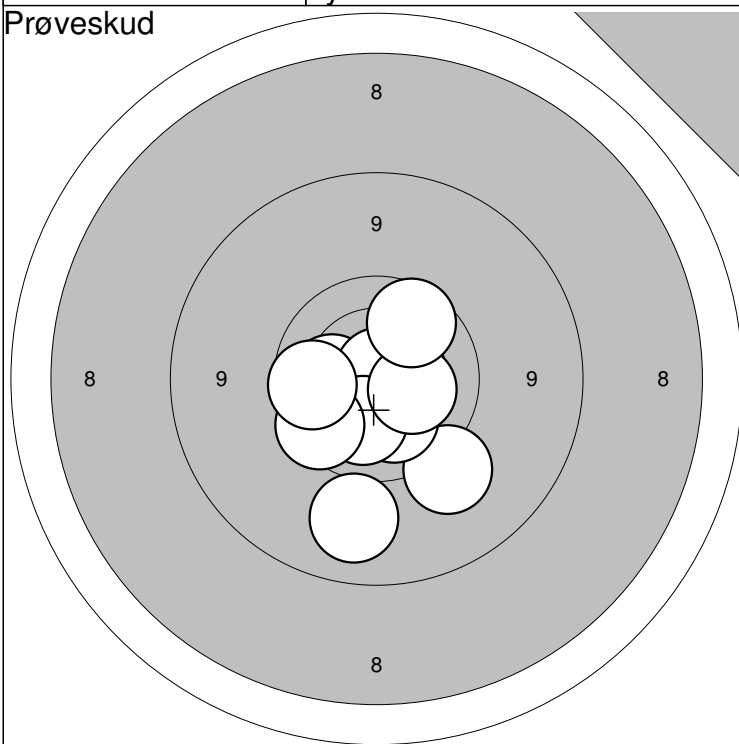

Prøveskud

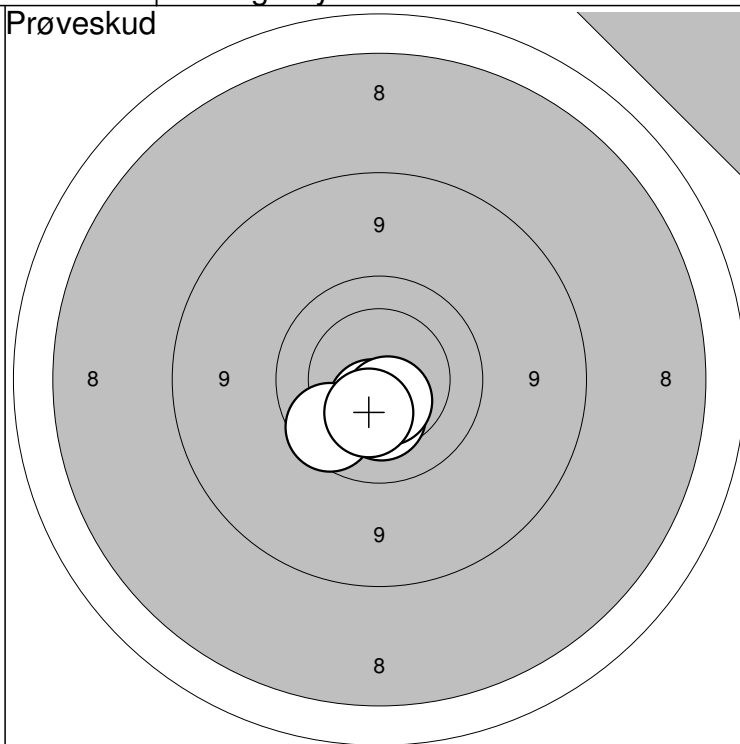

1: 9,4 ↘  
2: 10,2 ←  
3: 9,2 ↓  
4: 10,2 ↘  
5: 10,8\* ↗

6: 10,2 ↓  
7: 9,8 ↙  
8: 9,9 ←  
9: 10,3 →  
10: 9,9 ↗

Serie: 95,0

Sum: 0,0

11: 10,5\* ↓  
12: 10,3 ↓  
13: 9,9 ↙  
14: 10,6\* ↓  
15: 10,4 ↓

Serie: 49,0

Sum: 0,0

Gældende

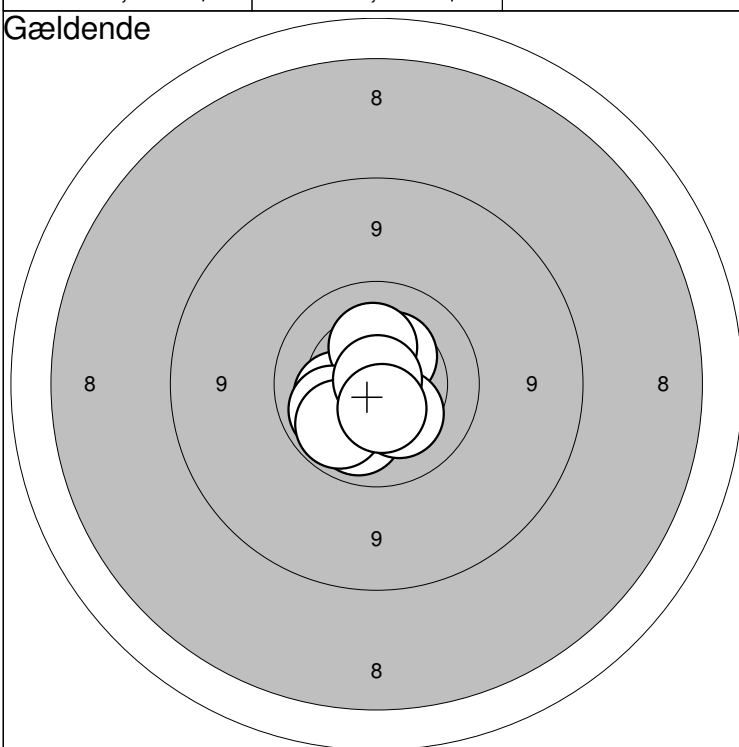

Gældende

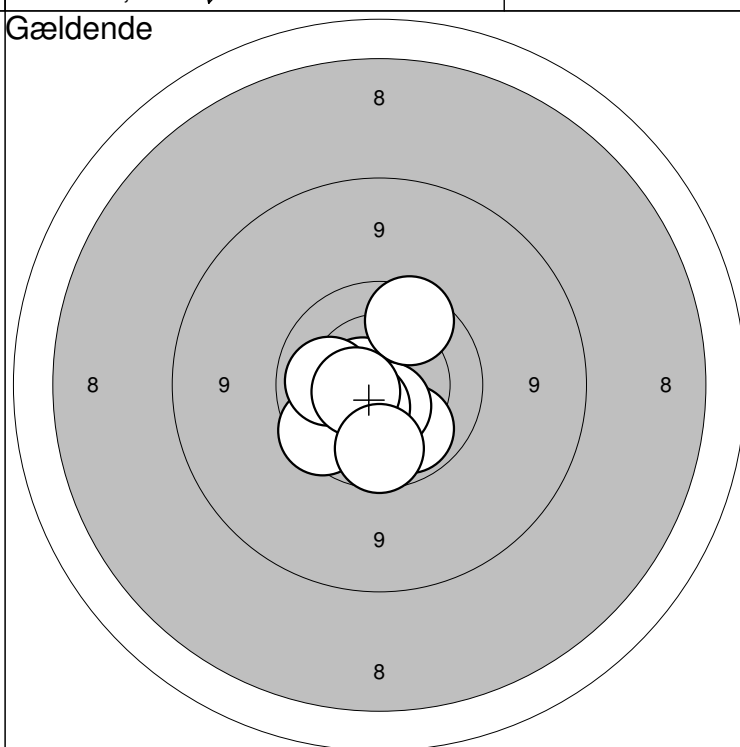

1: 10,5\* ↘  
2: 10,3 ←  
3: 10,4 ↗  
4: 10,3 ↑  
5: 10,1 ↓

6: 10,1 ←  
7: 10,0 ↓  
8: 10,3 ↘  
9: 10,9\* ↑  
10: 10,5\* ↓

Serie: 100,0

Sum: 100,0

11: 10,5 ↙  
12: 10,0 ↓  
13: 10,7\* ←  
14: 10,6\* ↓  
15: 9,8 ↗

16: 10,5\* ↘  
17: 9,8 ↙  
18: 10,1 ←  
19: 10,5\* ←  
20: 9,9 ↓

Serie: 97,0

Sum: 197,0

Jyllandsstævne 2011



Løgstør Skyttelaug

J1

Jyllandsstævne 2011 - riffel

Aalborg Skyttekreds

**Prøveskud**

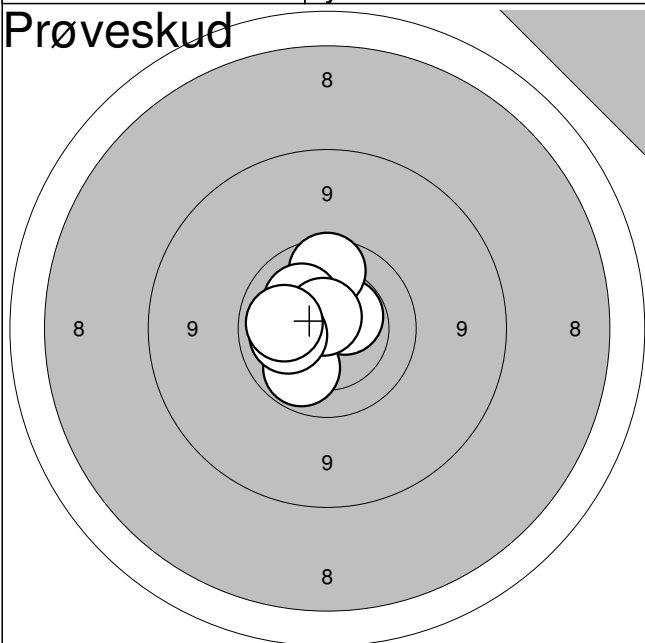

1:	10,5*	↗
2:	10,3	←
3:	9,9	↑
4:	10,2	↗
5:	10,0	↘
6:	10,7*	↑
7:	10,2	←
8:	10,1	←

Serie: 79,0

Sum: 0,0

**Gældende**

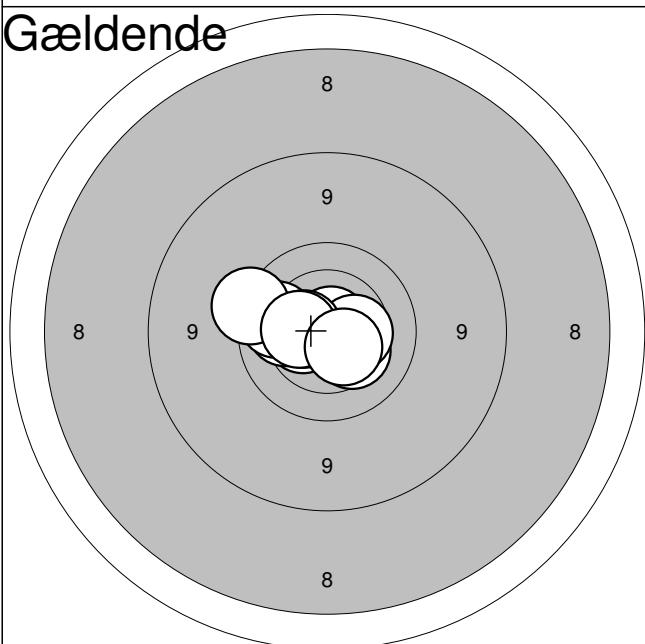

1:	10,5	←
2:	10,1	←
3:	9,9	←
4:	10,8*	↗
5:	10,3	↘
6:	10,4	→
7:	9,6	←
8:	10,5*	←
9:	10,4	←
10:	10,5*	↘

Serie: 98,0

Sum: 98,0

**Gældende**

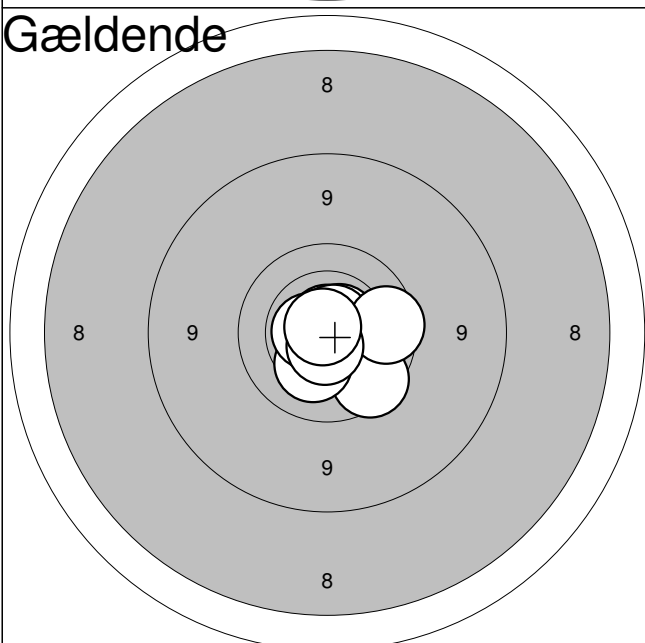

11:	9,8	↘
12:	10,8*	←
13:	10,8*	↑
14:	10,6*	↗
15:	10,3	↘
16:	10,7*	↗
17:	10,6*	←
18:	9,9	→
19:	10,7*	↘
20:	10,8*	↗

Serie: 98,0

Sum: 196,0

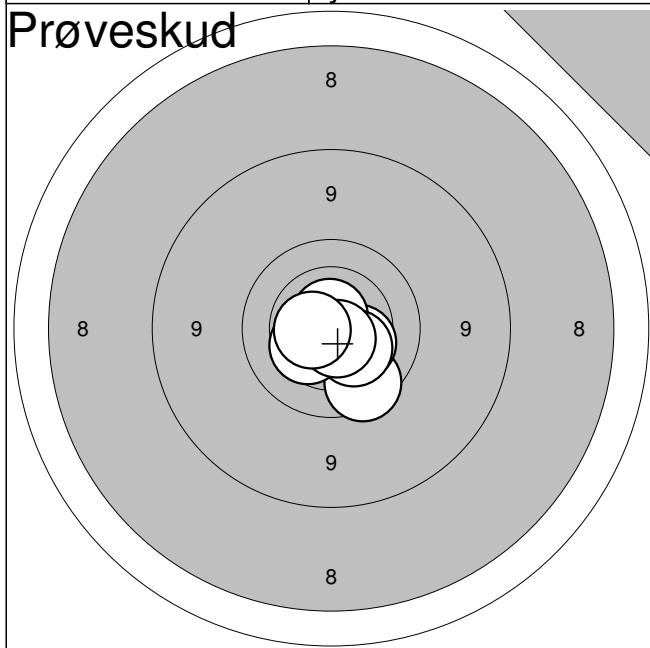

1:	9,8	↘
2:	10,4	↘
3:	10,7*	↑
4:	10,4	↘
5:	10,4	↙
6:	10,7*	↘
7:	10,6*	←

**Serie: 69,0**

**Sum: 0,0**

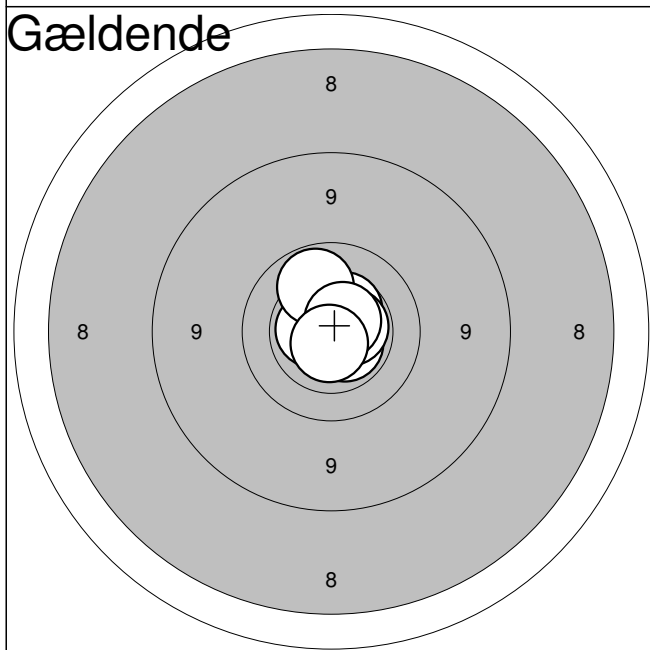

1:	10,5	↗
2:	10,9*	↘
3:	10,7*	→
4:	10,7*	↗
5:	10,6*	←
6:	10,6*	↘
7:	10,6*	→
8:	10,0	↗
9:	10,6*	↗
10:	10,7*	↘

**Serie: 100,0**

**Sum: 100,0**

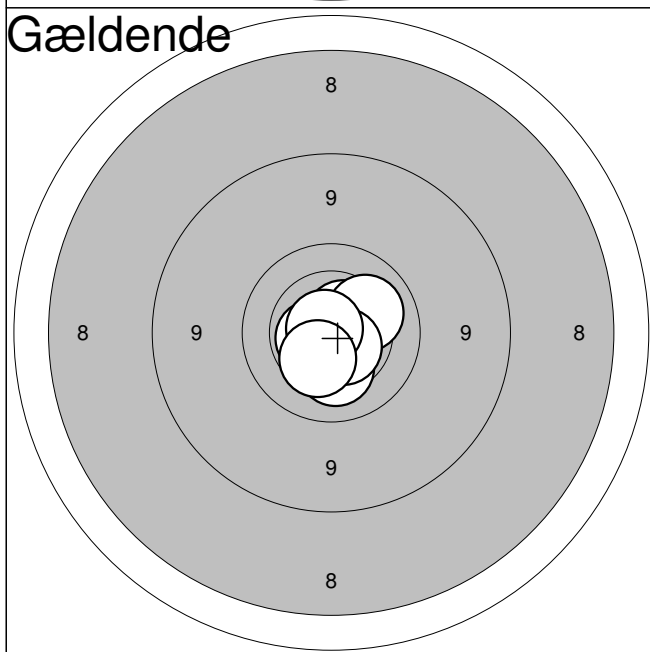

11:	10,6*	↗
12:	10,6*	←
13:	10,6*	↘
14:	10,6*	↗
15:	10,2	↗
16:	10,3	↘
17:	10,6*	↘
18:	10,6*	↘
19:	10,8*	↗
20:	10,4	↘

**Serie: 100,0**

**Sum: 200,0**

Hold

54

Bane

4

Christian S. Nielsen

Vilsted Skf.

BK1

Jyllandsstævne 2011 - riffel

Aalborg Skyttekreds

Prøveskud

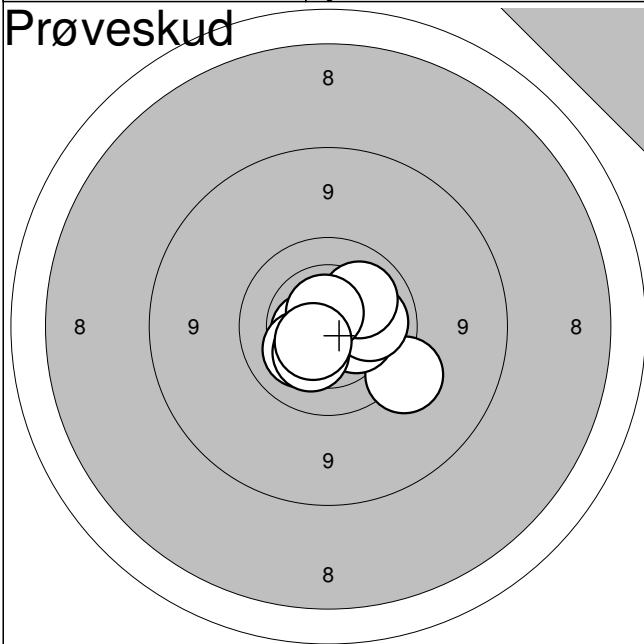

1: 9,5



2: 10,6\*



3: 10,4



4: 10,1



5: 10,3



6: 10,1



7: 10,3



8: 10,7\*



9: 10,5\*



Serie:

89,0

Sum:

0,0

Gældende

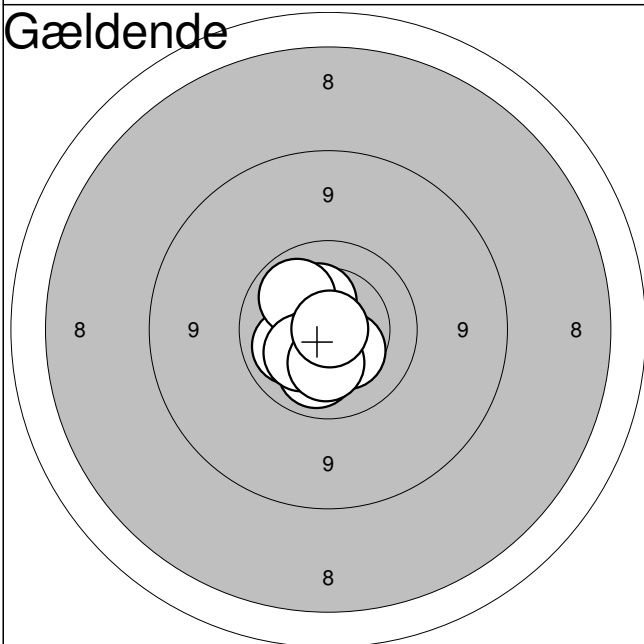

1: 10,1



2: 10,2



3: 10,4



4: 10,4



5: 10,4



6: 10,1



7: 10,5\*



8: 10,3



9: 10,3



10: 10,9\*



Serie:

100,0

Sum:

100,0

Gældende

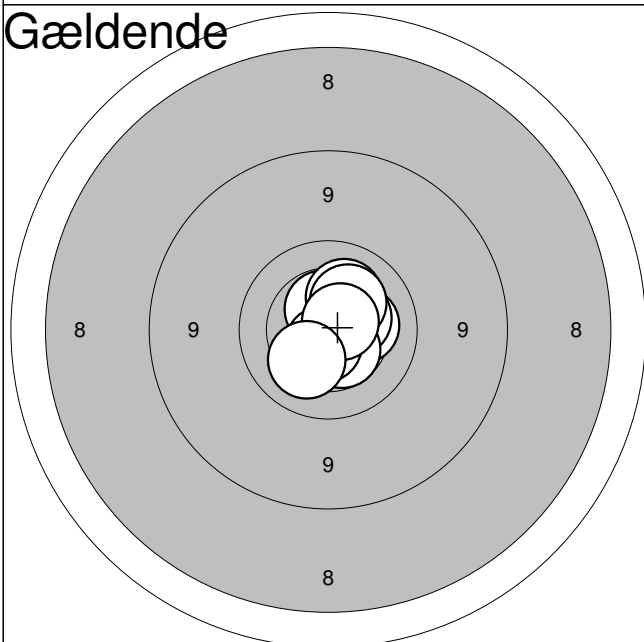

11: 10,3



12: 10,8\*



13: 10,4



14: 10,5\*



15: 10,5



16: 10,2



17: 10,3



18: 10,7\*



19: 10,7\*



20: 10,2



Serie:

100,0

Sum:

200,0

Jyllandsstævne 2011

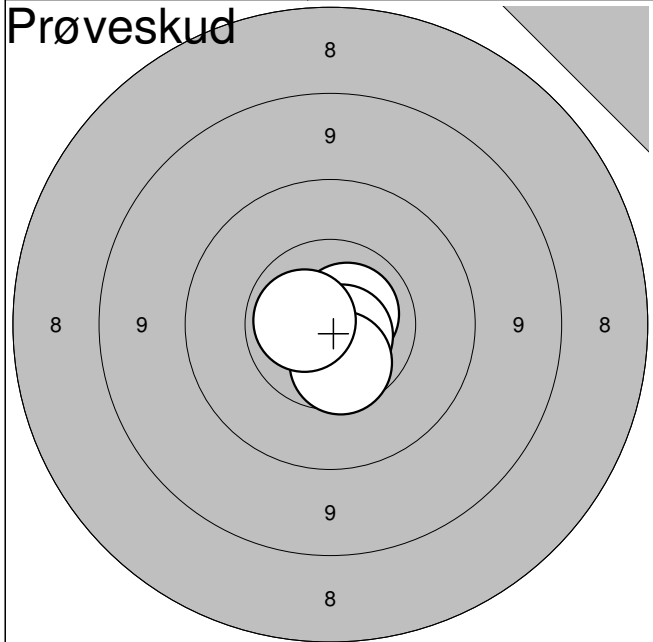

1:	10,7*	↗
2:	10,8*	↘
3:	10,5	↘
4:	10,7*	↖

<b>Serie:</b>	<b>40,0</b>
<b>Sum:</b>	<b>0,0</b>

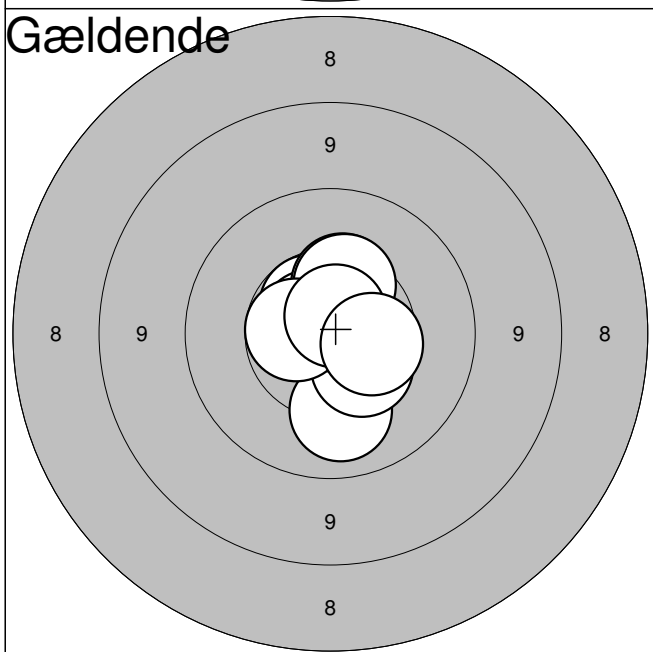

1:	10,1	↘
2:	10,6*	↗
3:	10,7*	↗
4:	10,4	↗
5:	10,5	↘
6:	10,8*	↗
7:	10,4	↗
8:	10,6*	↖
9:	10,8*	↗
10:	10,5	→

<b>Serie:</b>	<b>100,0</b>
<b>Sum:</b>	<b>100,0</b>

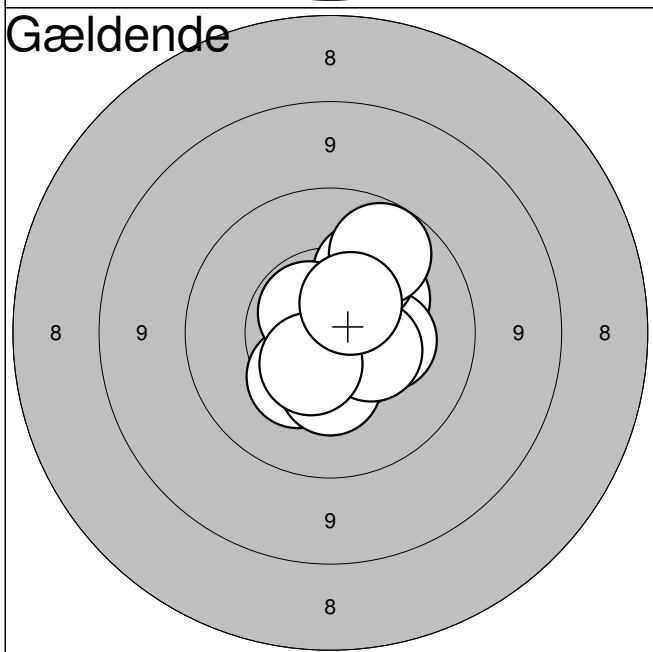

11:	10,4	↘
12:	10,3	↗
13:	10,4	↘
14:	10,4	→
15:	10,2	↗
16:	10,0	↗
17:	10,5	↘
18:	10,6*	↗
19:	10,6	↘
20:	10,6	↗

<b>Serie:</b>	<b>100,0</b>
<b>Sum:</b>	<b>200,0</b>

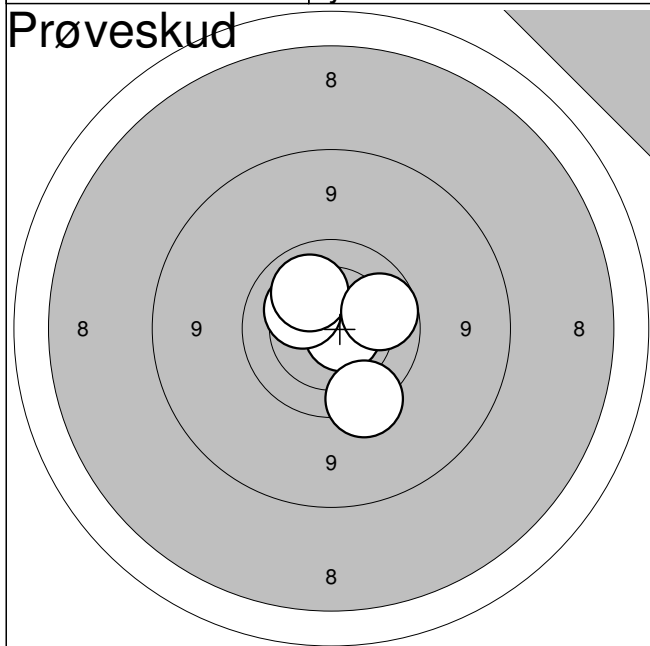

1:	10,7*	↘
2:	10,3	↗
3:	10,1	↗
4:	9,7	↘
5:	9,9	→

**Serie: 48,0**

**Sum: 0,0**

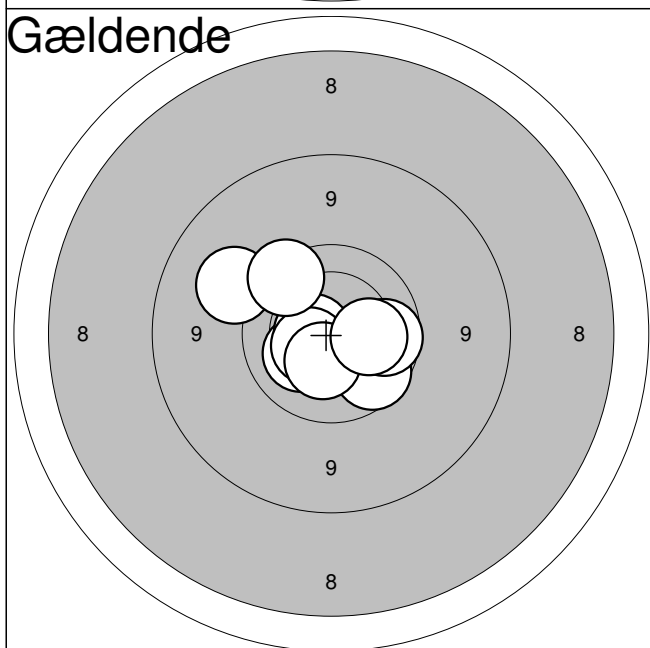

1:	10,2	↘
2:	10,6*	←
3:	10,3	↘
4:	9,3	↗
5:	10,5	↘
6:	9,9	↘
7:	10,4	↘
8:	9,9	→
9:	9,7	↗
10:	10,2	→

**Serie: 96,0**

**Sum: 96,0**

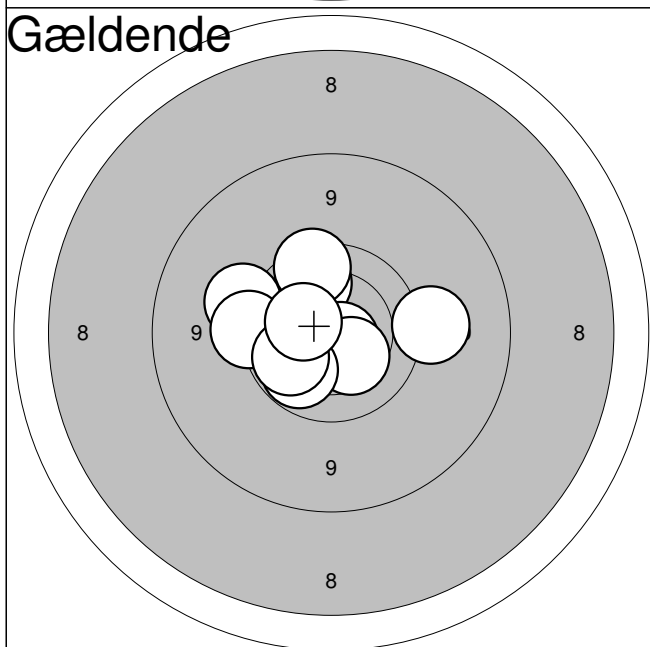

11:	9,9	↗
12:	10,7*	↘
13:	10,3	↘
14:	9,8	↗
15:	9,4	→
16:	9,5	↖
17:	10,0	↘
18:	9,6	←
19:	10,0	↘
20:	10,4	↖

**Serie: 95,0**

**Sum: 191,0**

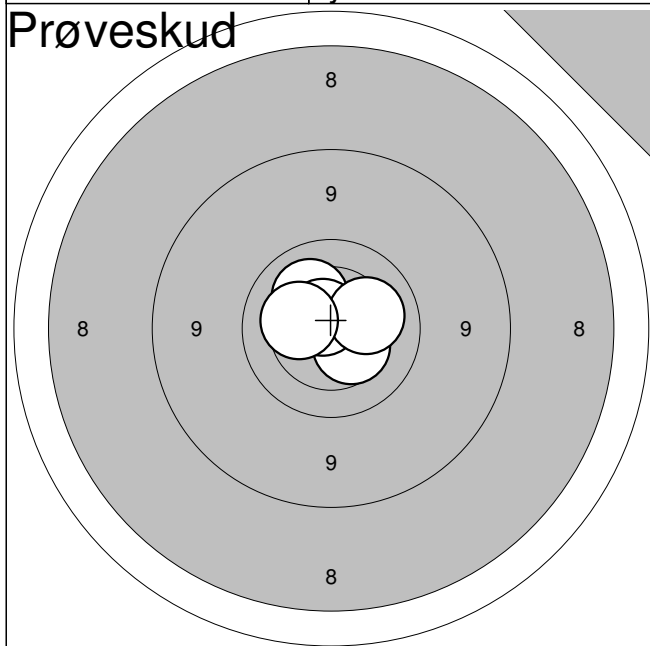

1:	10,4	↘
2:	10,2	↗
3:	10,7*	↗
4:	10,2	→
5:	10,3	←

**Serie: 50,0**

**Sum: 0,0**

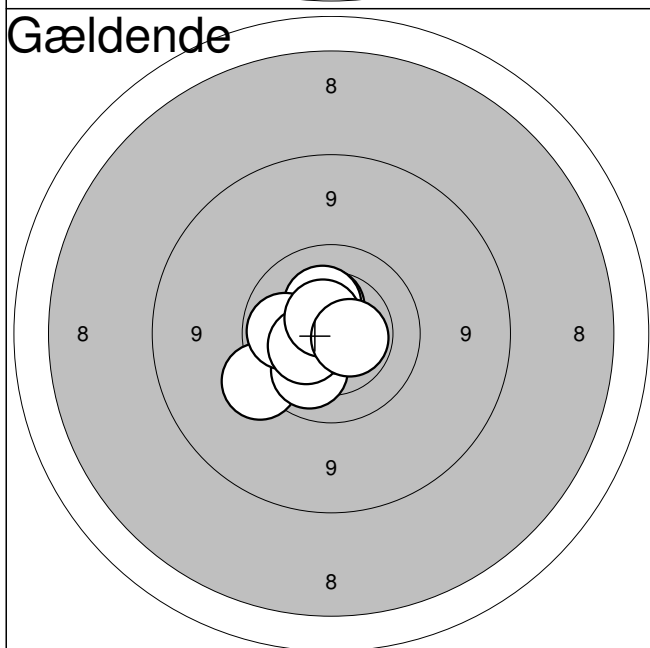

1:	9,6	↙
2:	10,4	↑
3:	10,4	↑
4:	10,7*	↗
5:	10,1	↘
6:	10,1	←
7:	10,8*	→
8:	10,4	↙
9:	10,6*	↗
10:	10,6*	→

**Serie: 99,0**

**Sum: 99,0**

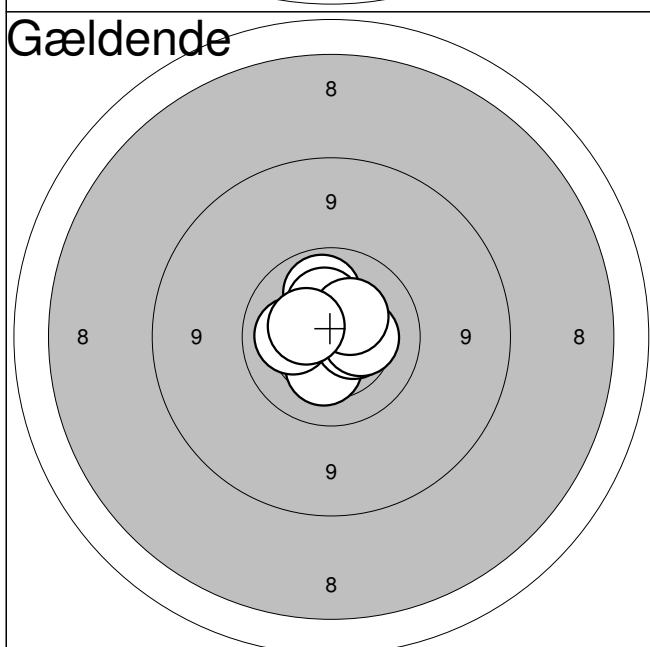

11:	10,6*	↗
12:	10,1	↑
13:	10,3	↘
14:	10,7*	↗
15:	10,5*	→
16:	10,4	→
17:	10,2	←
18:	10,3	↑
19:	10,4	↗
20:	10,4	←

**Serie: 100,0**

**Sum: 199,0**

Hold  
**55**Bane  
**2****Claus Nielsen**

Aalborg Skyttekreds

2

Jyllandsstævne 2011 - riffel

Aalborg Skyttekreds

Prøveskud

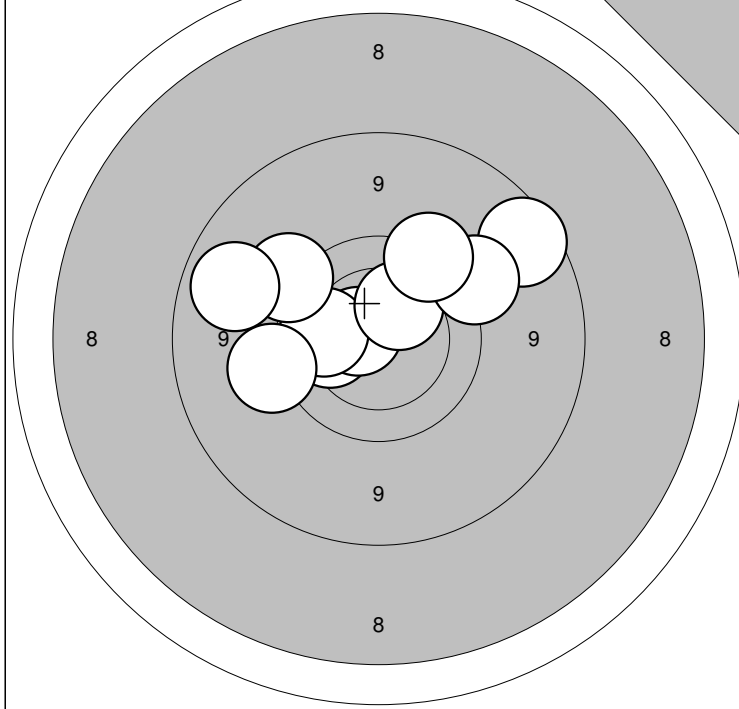

Prøveskud

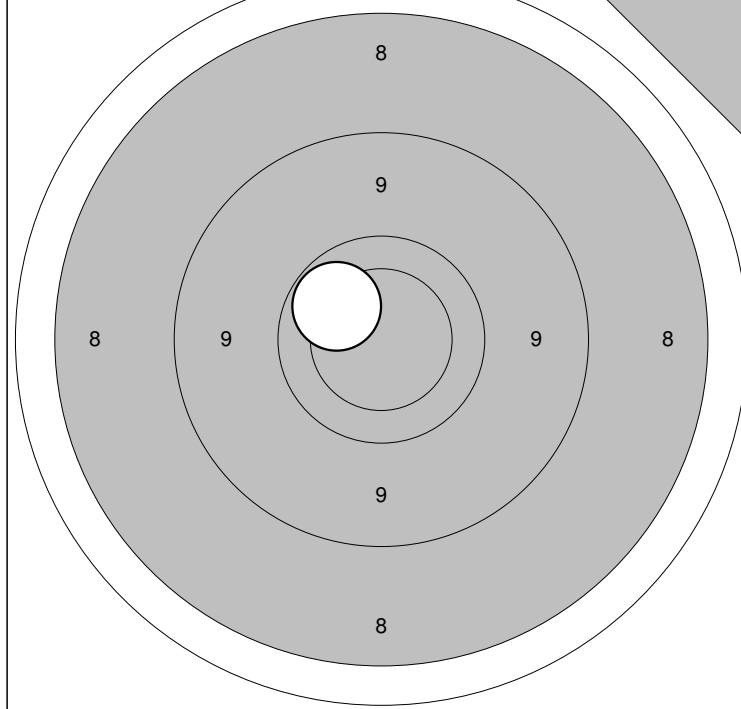

1:10,1 ←  
2:10,6\* ←  
3:10,0 ←  
4:10,3 ↗  
5: 9,5 ↖

6: 8,9 ↗  
7: 9,4 ←  
8: 9,0 ←  
9: 9,4 ↗  
10: 9,6 ↗

Serie: 93,0  
Sum: 0,0

11:10,0 ↖

Serie: 10,0  
Sum: 0,0

Gældende

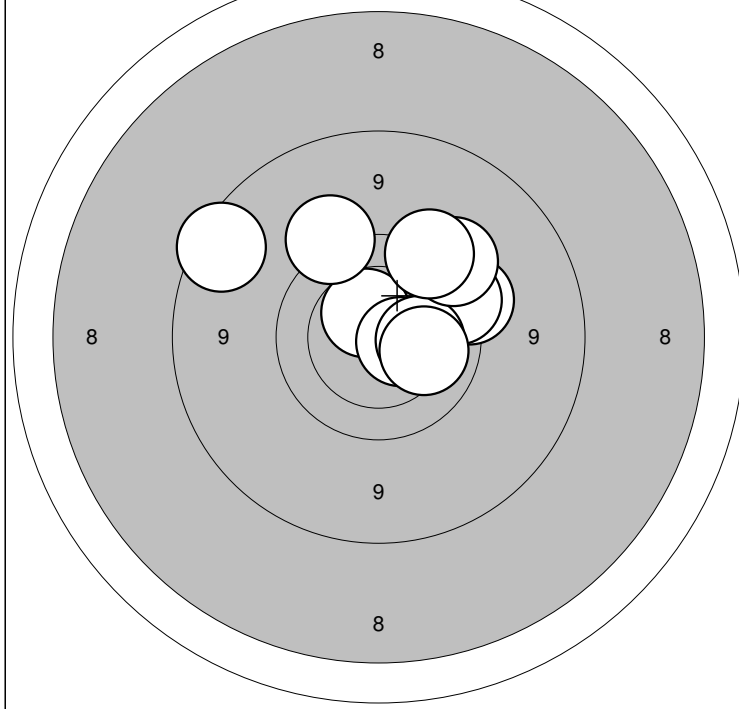

Gældende

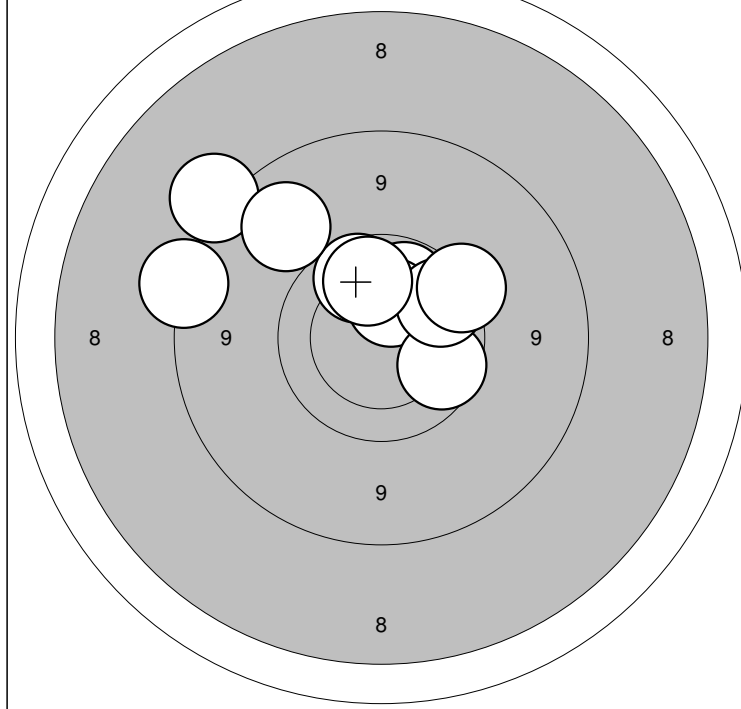

1: 9,6 ↗  
2: 9,7 ↗  
3:10,5 ↗  
4: 8,8 ↖  
5: 9,5 ↗

6:10,6\* →  
7:10,2 →  
8: 9,5 ↗  
9: 9,6 ↗  
10:10,1 →

Serie: 93,0  
Sum: 93,0

11:10,0 ↗  
12: 8,7 ←  
13: 8,6 ↖  
14:10,3 ↗  
15: 9,9 ↗

16: 9,9 →  
17: 9,9 ↗  
18: 9,1 ↖  
19:10,0 ↗  
20: 9,6 ↗

Serie: 91,0  
Sum: 184,0

Jyllandsstævne 2011

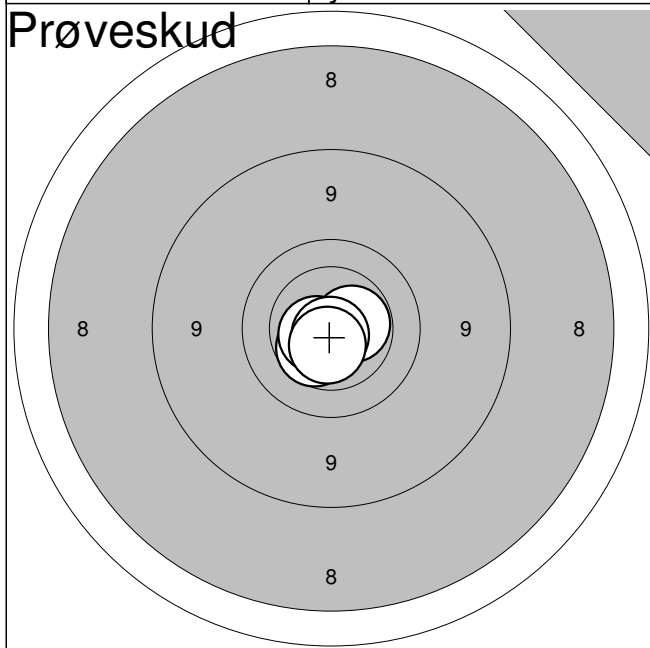

1:	10,4	↘
2:	10,6*	←
3:	10,5*	→
4:	10,8*	↓
5:	10,6*	↓

Serie:	50,0
Sum:	0,0

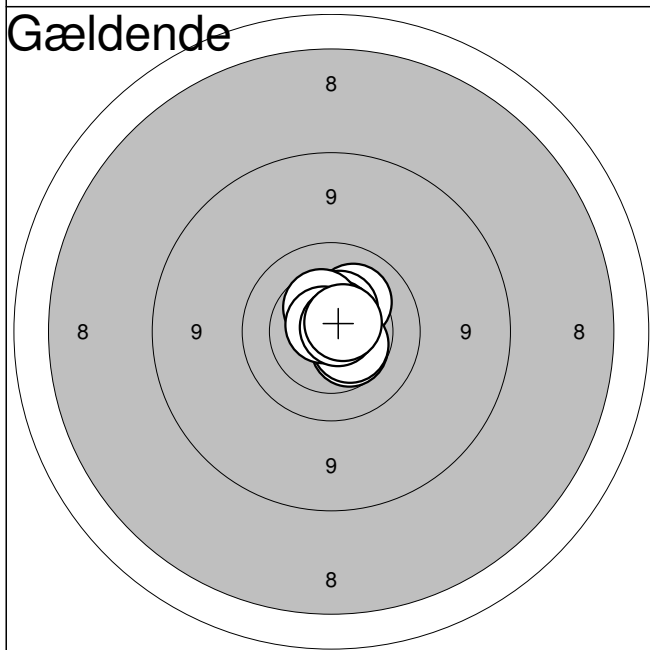

1:	10,7*	↗
2:	10,2	↗
3:	10,5	↗
4:	10,5	↘
5:	10,7*	↗
6:	10,5	↗
7:	10,5	↘
8:	10,8*	↗
9:	10,8*	→
10:	10,7*	↗

Serie:	100,0
Sum:	100,0

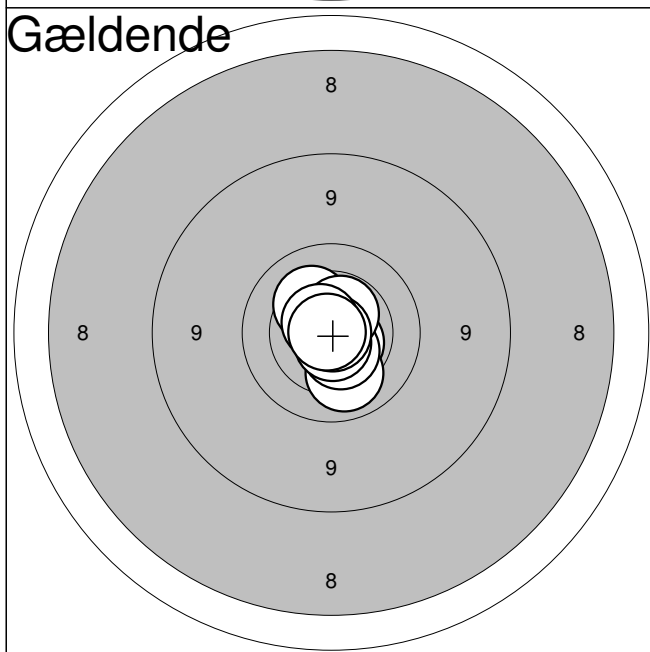

11:	10,6*	↘
12:	10,7*	↘
13:	10,1	↘
14:	10,5*	↘
15:	10,3	↗
16:	10,5*	↗
17:	10,7*	↘
18:	10,9*	→
19:	10,7*	↗
20:	10,9*	←

Serie:	100,0
Sum:	200,0



Hold

55

Bane

4

Marcus Hovkjær

Vilsted Skf.

BK2

Jyllandsstævne 2011 - riffel

Aalborg Skyttekreds

Prøveskud

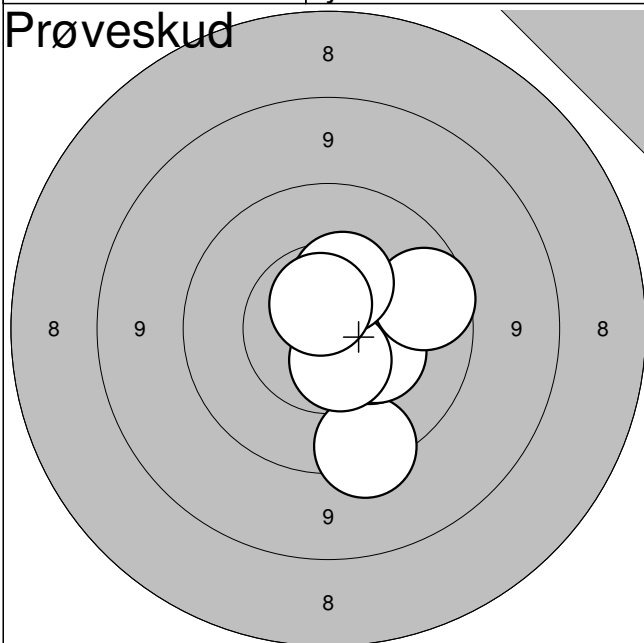

1:	9,6	↓
2:	10,4	↘
3:	10,4	→
4:	10,6*	↑
5:	9,9	→
6:	10,6	↓
7:	10,4	↑
8:	10,7*	↑

Serie: 78,0

Sum: 0,0

Gældende

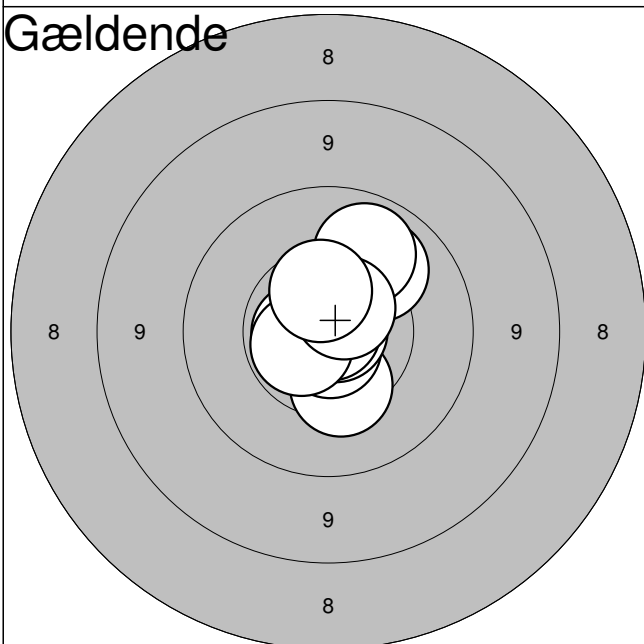

1:	10,7*	←
2:	10,1	↗
3:	10,4	↓
4:	10,8*	↓
5:	10,9*	→
6:	10,9*	↗
7:	10,0	↑
8:	10,6*	←
9:	10,6*	↗
10:	10,5	↑

Serie: 100,0

Sum: 100,0

Gældende

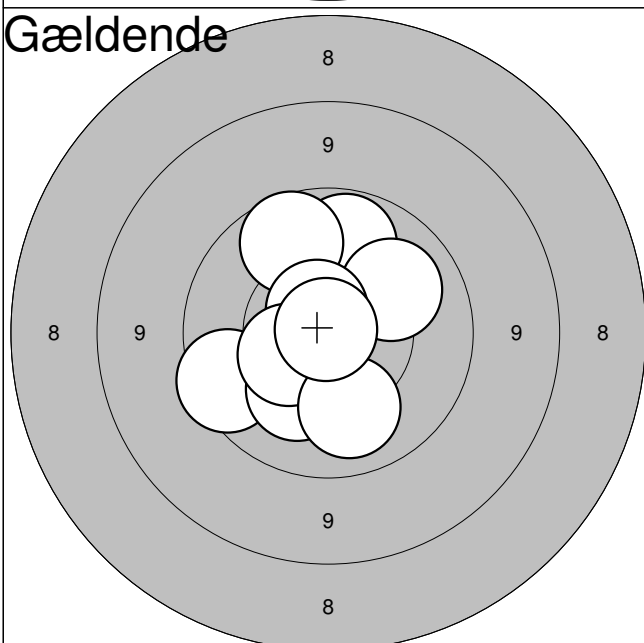

11:	10,8*	↑
12:	10,0	↑
13:	9,8	←
14:	10,1	↗
15:	9,9	↑
16:	10,7*	↗
17:	10,3	↓
18:	10,5	←
19:	10,1	↓
20:	10,9*	↗

Serie: 98,0

Sum: 198,0

Jyllandsstævne 2011

Hold  
**55**Bane  
**7****Lasse E. Nielsen**

Aalborg Skyttekreds

J2

Jyllandsstævne 2011 - riffel

Aalborg Skyttekreds

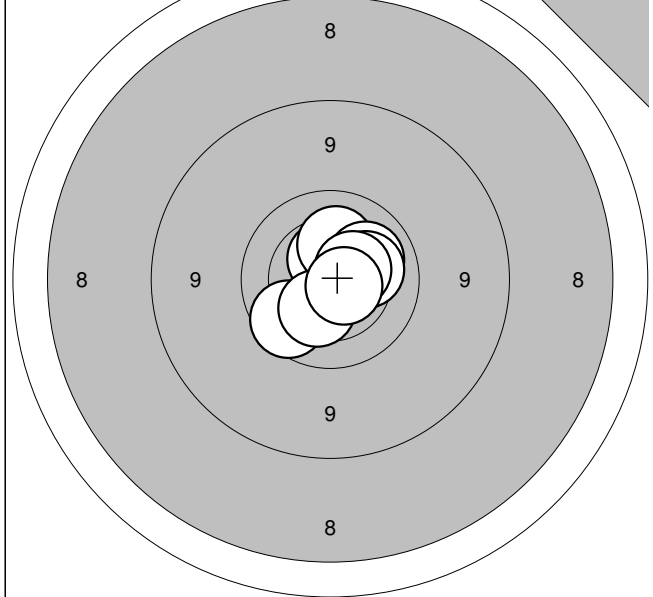
**Prøveskud**

1:	10,5*	↑
2:	9,9	↙
3:	10,3	↑
4:	10,2	→
5:	10,3	↘
6:	10,2	→
7:	10,5	→
8:	10,6*	↘

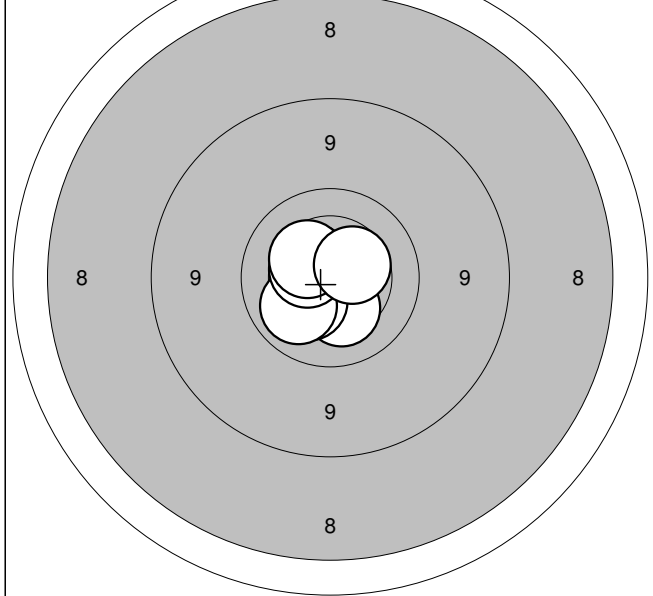
Serie: **79,0**Sum: **0,0****Gældende**

1:	10,5*	↓
2:	10,6*	↙
3:	10,6*	↘
4:	10,3	↓
5:	10,3	↘
6:	10,1	↙
7:	10,5*	↗
8:	10,5	←
9:	10,4	↗
10:	10,5	→

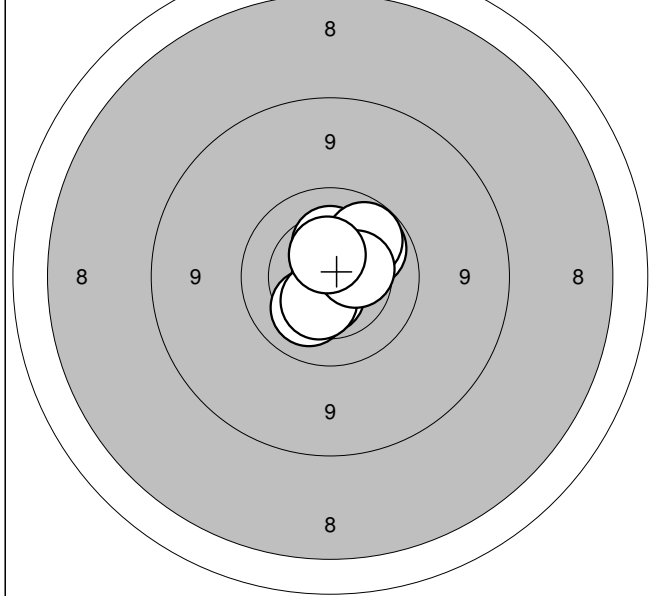
Serie: **100,0**Sum: **100,0****Gældende**

11:	10,2	↘
12:	10,3	↑
13:	10,9*	↓
14:	10,8*	↑
15:	10,0	↗
16:	10,6*	↘
17:	10,4	↘
18:	10,0	↗
19:	10,4	→
20:	10,5*	↑

Serie: **100,0**Sum: **200,0**

Jyllandsstævne 2011

Hold  
**55**

Bane  
**9**

# Jonas Engberg Hansen

Vilsted Skf.

BK3

Jyllandsstævne 2011 - riffel

Aalborg Skyttekreds

Prøveskud

Prøveskud

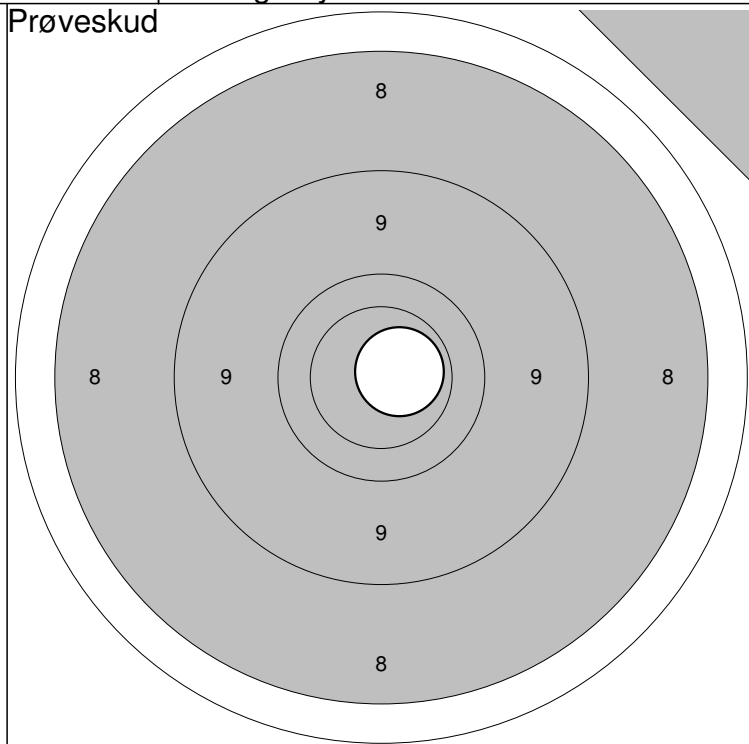
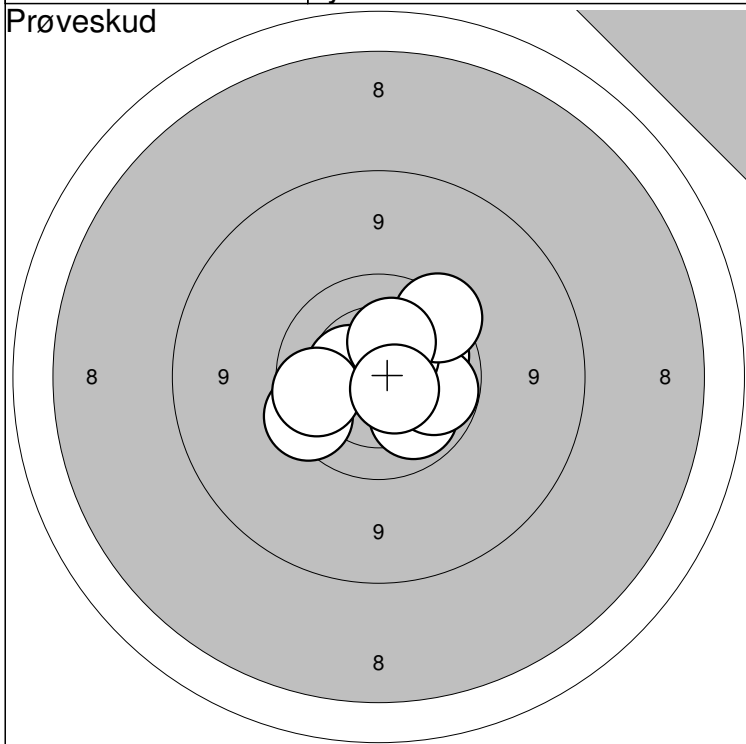

1:10,1 →

2:10,1 ↘

3:10,0 →

4:10,5\* ↗

5: 9,7 ↗

6: 9,7 ←

7:10,5 ←

8: 9,9 ←

9:10,3 ↗

10:10,6\* ↘

Serie: 97,0

Sum: 0,0

11:10,6\* →

Serie: 10,0

Sum: 0,0

Gældende

Gældende

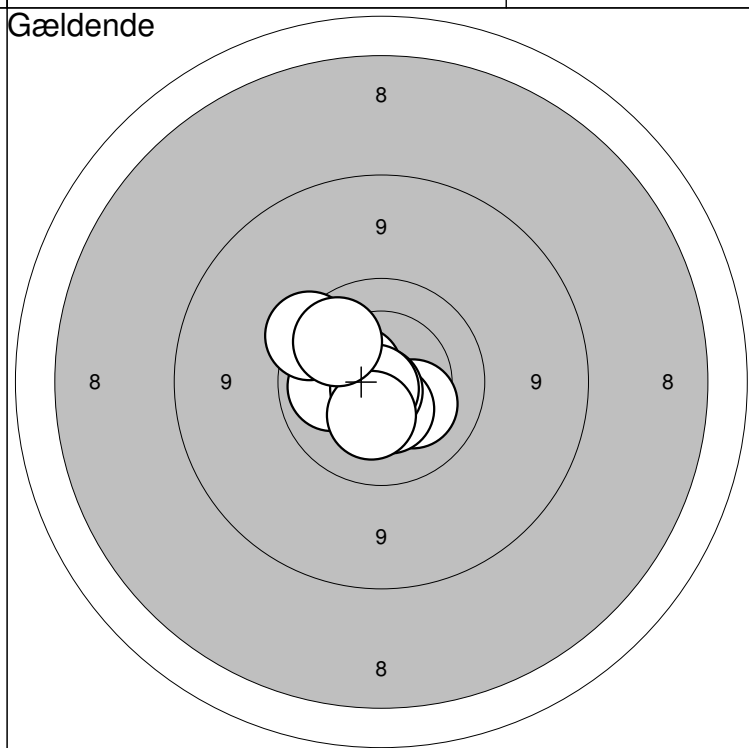
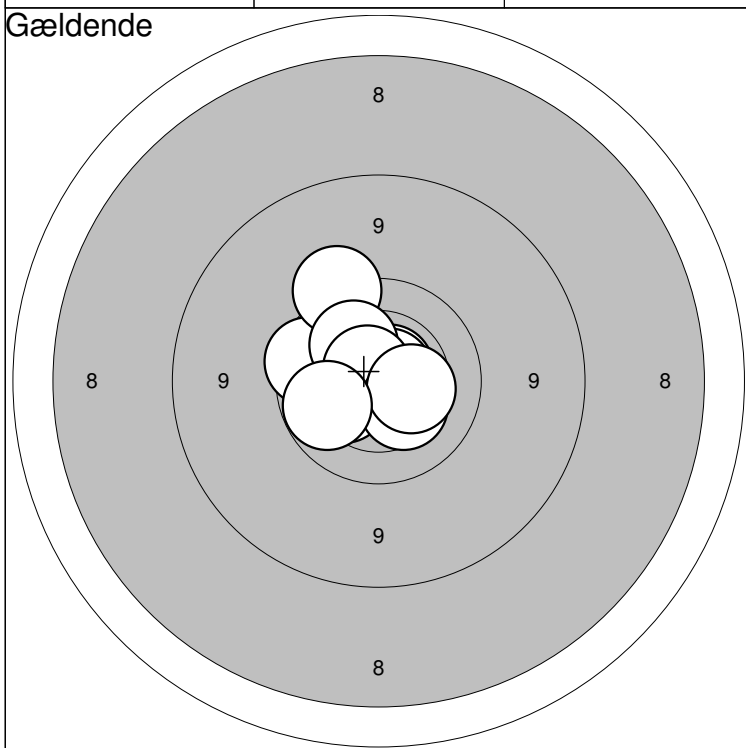

1: 9,8 ←

2:10,7\* ↗

3:10,7\* ↗

4:10,3 ←

5: 9,6 ↗

6:10,2 ↗

7:10,7\* ↗

8:10,4 ↘

9:10,4 →

10:10,0 ←

Serie: 98,0

Sum: 98,0

11:10,3 ↘

12:10,5 ↘

13:10,5\* ←

14:10,1 ←

15:10,1 ←

16:10,8\* ↘

17: 9,7 ↘

18:10,8\* ↘

19:10,4 ↘

20:10,0 ↗

Serie: 99,0

Sum: 197,0

Jyllandsstævne 2011

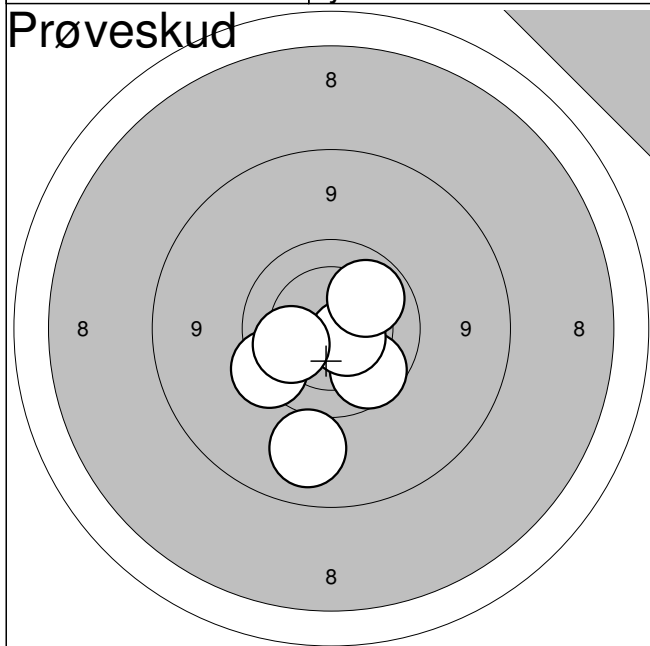

1:	9,2	↓
2:	9,9	↓
3:	9,7	↙
4:	10,6*	↘
5:	10,1	↖
6:	10,1	↗

**Serie: 57,0**

**Sum: 0,0**

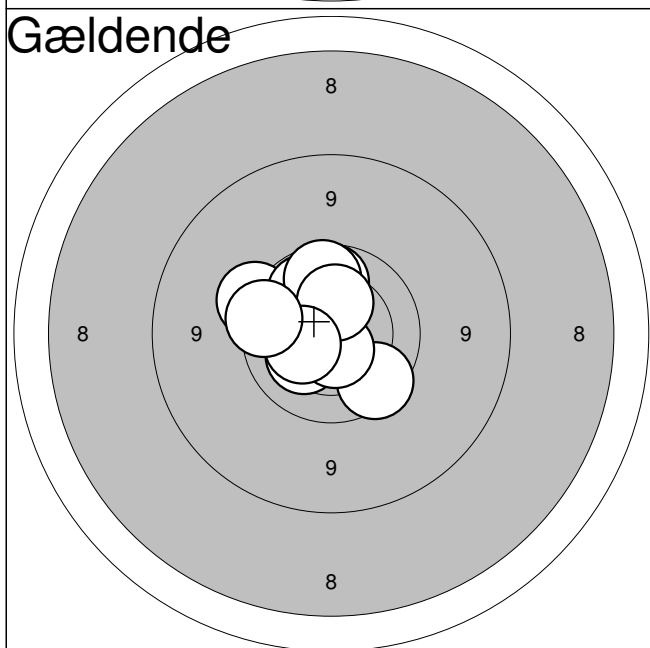

1:	9,8	↘
2:	9,6	↖
3:	10,3	↙
4:	10,0	↑
5:	10,6*	↓
6:	10,0	↗
7:	9,9	↑
8:	10,3	↑
9:	10,4	↖
10:	9,8	↖

**Serie: 96,0**

**Sum: 96,0**

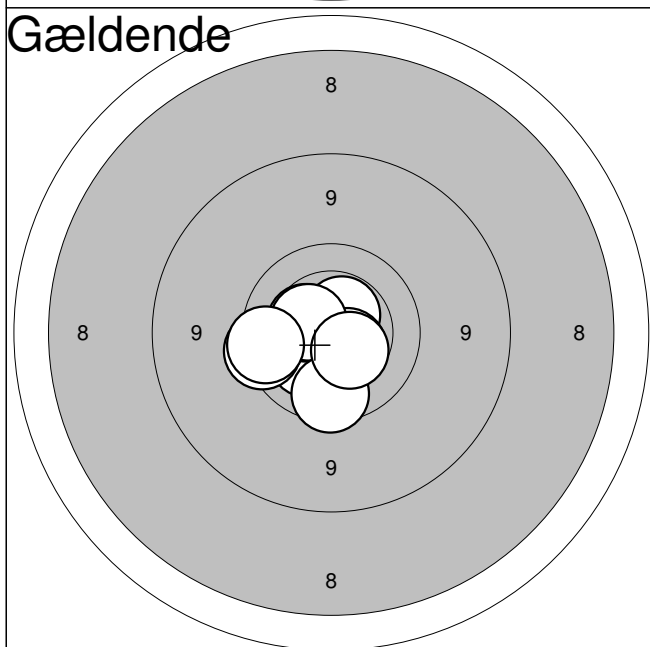

11:	10,5*	↗
12:	10,6*	↓
13:	10,3	↙
14:	10,5*	↘
15:	10,4	↖
16:	10,5	↖
17:	9,8	↓
18:	10,4	↘
19:	9,7	↖
20:	9,8	↖

**Serie: 97,0**

**Sum: 193,0**

Hold

55

Bane

12

Nikolai Wahlgreen

Vilsted Skf.

ÅK2

Jyllandsstævne 2011 - riffel

Aalborg Skyttekreds

Prøveskud

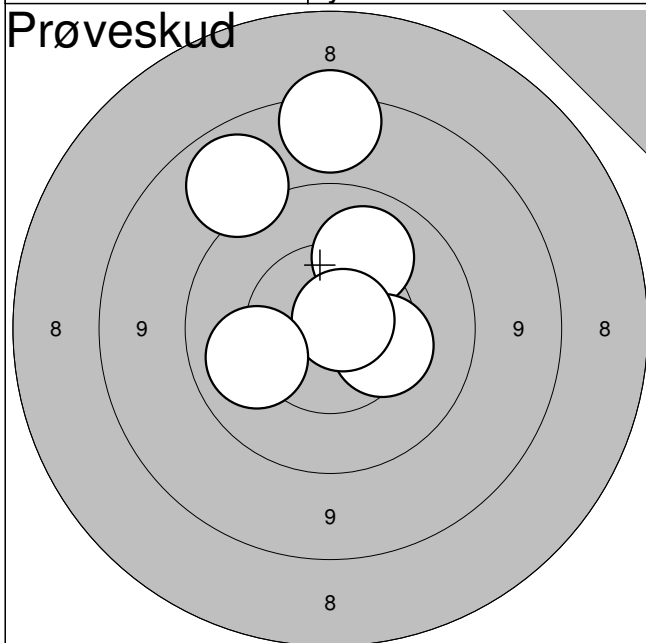

1: 9,1  
 2: 8,6  
 3: 10,1  
 4: 10,4  
 5: 10,8\*  
 6: 10,1

↖  
 ↑  
 ↗  
 →  
 ↘  
 ←

Serie: 57,0

Sum: 0,0

Gældende

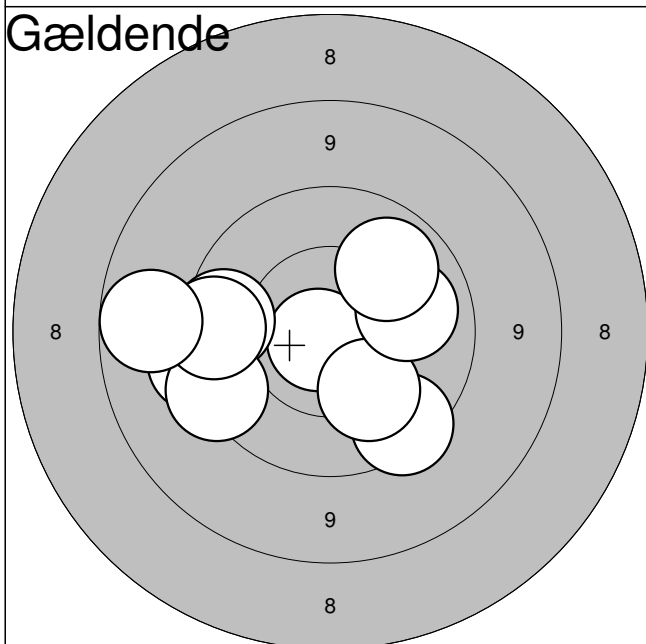

1: 10,8\*  
 2: 9,8  
 3: 9,5  
 4: 9,6  
 5: 9,7  
 6: 9,7  
 7: 10,2  
 8: 10,1  
 9: 10,1  
 10: 9,0

↙  
 ←  
 ←  
 ↙  
 ←  
 ↘  
 ↘  
 →  
 ↗  
 ←

Serie: 94,0

Sum: 94,0

Gældende

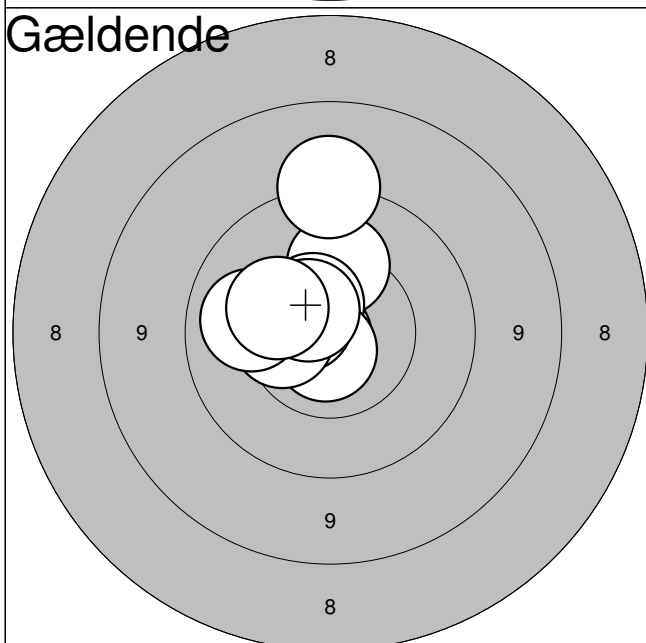

11: 10,2  
 12: 10,8\*  
 13: 9,4  
 14: 10,6\*  
 15: 10,8\*  
 16: 10,6\*  
 17: 10,4  
 18: 10,6\*  
 19: 10,1  
 20: 10,3

↑  
 ←  
 ↑  
 ↗  
 ↘  
 ←  
 ←  
 ↗  
 ←  
 ↖

Serie: 99,0

Sum: 193,0

Jyllandsstævne 2011

Hold

56

Bane

12

Nikolai Wahlgreen

Vilsted Skf.

ÅK2

Jyllandsstævne 2011 - riffel

Aalborg Skyttekreds

Prøveskud

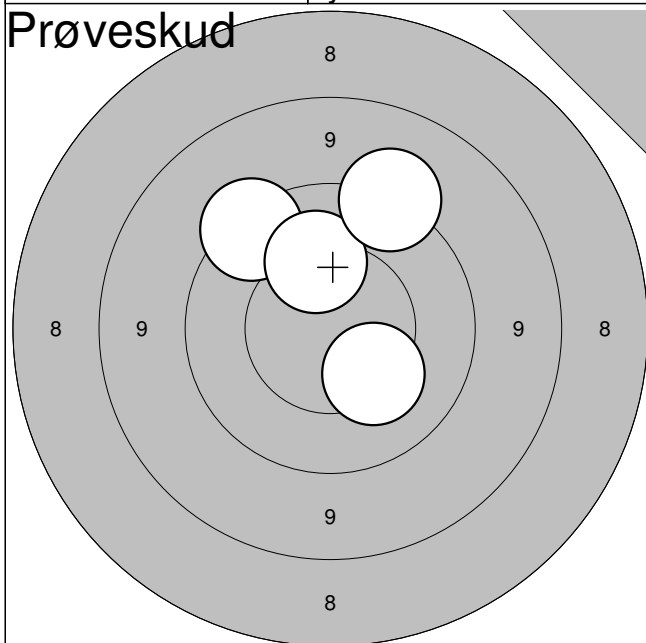

1: 9,6



2: 10,2



3: 10,3



4: 9,4



Serie: 38,0

Sum: 0,0

Gældende

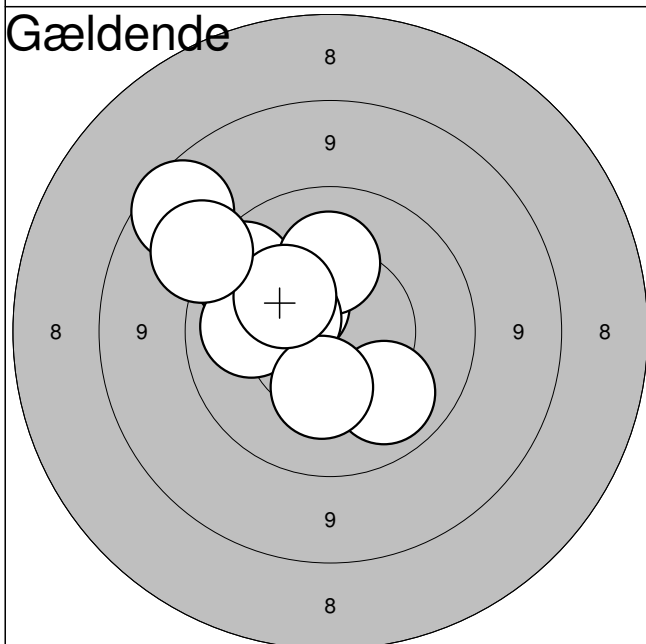

1: 10,1



2: 10,5



3: 9,8



4: 10,2



5: 10,5



6: 10,1



7: 10,4



8: 8,8



9: 10,3



10: 9,3



Serie: 96,0

Sum: 96,0

Gældende

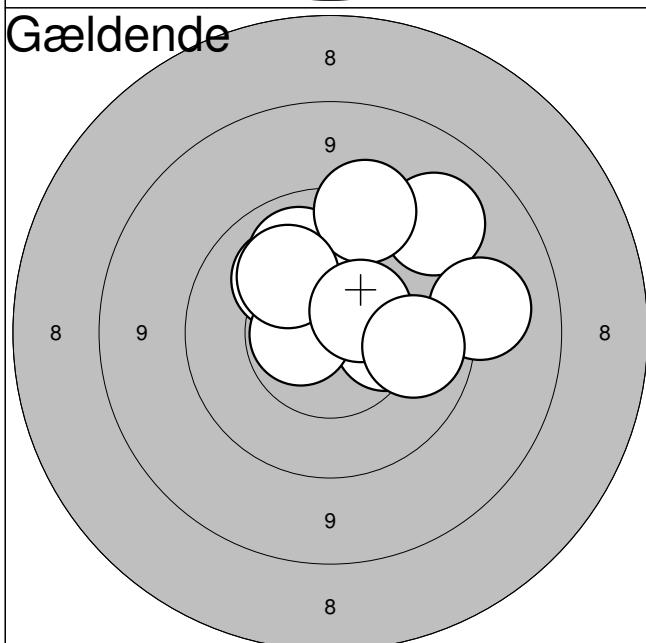

11: 10,2



12: 10,4



13: 9,3



14: 10,6\*



15: 10,1



16: 9,6



17: 9,3



18: 10,2



19: 10,6



20: 10,1



Serie: 97,0

Sum: 193,0

Jyllandsstævne 2011